



***PULSE PROGRAM
CATALOGUE:
I. 1D & 2D NMR
EXPERIMENTS***

Teodor Parella

Servei RMN, Universitat Autònoma de Barcelona

E-mail: teodor.parella@uab.cat



***TOPSPIN v2.0
NMRGuide***



UAB

Copyright (C) 2006 by Bruker BioSpin GmbH
All rights reserved. No part of this publication may be reproduced, stored in a retrieval system,
or transmitted, in any form, or by any means without the prior consent of the publisher.

03-03-2006
Part Number -----

Product names used are trademarks or registered trademarks of their respective holders.

VOLUME I: 1D & 2D NMR EXPERIMENTS

• Table of Contents	1-2
• Introduction	3-6
• Standard Pulse Schemes	
1. Basic 1D pulse sequences.....	7
2. T1 & T2 Relaxation.....	13
3. Selective Excitation & Selective 1D Experiments.....	15
4. 1D Solvent suppression.....	21
Presaturation	
Jump and Return	
Watergate	
Excitation Sculpting	
WET	
5. ¹⁹ F specific experiments.....	27
6. ² H specific experiments.....	29
7. Basic 1D Gradients.....	31
• Homonuclear Experiments	
8. 2D COSY.....	33
9. 2D COSY-DQF.....	37
10. 2D SECSY.....	41
11. 2D RELAY.....	43
12. 2D TOCSY.....	47
13. 2D ROESY.....	53
14. 2D NOESY.....	57
15. 1D & 2D Double-Quantum.....	63
16. 2D J-Resolved.....	67
• Heteronuclear 1D & 2D X-detected experiments	
17. Decoupler Pulse Calibration.....	69
18. 1D DEPT & INEPT.....	73
19. 2D HETCOR.....	81
20. 2D COLOC.....	87
21. 2D Heteronuclear J-resolved.....	89
22. 2D HOESY.....	91
23. 1D & 2D INADEQUATE.....	93
• 2D Inverse Experiments	
24. Basic 1D Inverse.....	97
Direct 2D Correlations	
25. HMQC.....	101
26. DEPT-HMQC.....	111
27. HSQC.....	113
28. Multiplicity-edited HSQC.....	127
29. Constant-time correlations.....	133
CT-HSQC	
CT-HMQC	
30. Inverse-INEPT.....	137
31. Spin-edited HSQC for ¹ J(XH) determination.....	139
2D HSQC- α,β	
2D IPAP-HSQC	
2D J-modulated CT-HSQC	
32. TROSY.....	145
33. CRINEPT.....	151
2D HMQC hybrids	
34. HMQC-COSY.....	153
H2BC.....	
35. HMQC-TOCSY.....	157

36. HMQC-ROESY.....	163
37. HMQC-NOESY.....	167
2D HSQC hybrids	
38. HSQC-TOCSY	171
39. HSQC-ROESY	179
40. HSQC-NOESY	183
2D Long-Range Correlations	
41. HMBC	187
42. Measurement of long-range proton-carbon coupling constants	193
Phase-sensitive HMBC	
CT-HMBC	
J-HMBC	
Long-range HSQC (HSQMBC)	
EXSIDE	
HETLOC	
HSQC-HECADE	
43. ADEQUATE	201
1,1-ADEQUATE	
1,n-ADEQUATE	
n,1-ADEQUATE	
n,n-ADEQUATE	
• Miscellaneous Experiments	
44. 1D, 2D & 3D Diffusion/DOSY.....	207
STE	
STEBP	
DSTE	
DSTEBP	
LED	
LEDBP	
DOSY-COSY	
DOSY-TOCSY	
DOSY-NOESY	
45. 1D & 2D Saturation Transfer Difference (STD).....	213
STD-TOCSY	
STD-NOESY	
STD-HSQC	
46. 1D & 2D Experiments using CLEANEX.....	223
CLEANEX-HSQC	
CLEANEX-TROSY	
47. 1D & 2D LC-NMR Experiments.....	227
48. Basic Solid-State NMR Experiments.....	235
• Appendix 1. Pulse Program Info.....	237
• Appendix 2. Pulse Program Parameters	241
• Appendix 3. Relations with edprosol/getprosol	246
<u>VOLUME II: BIOMOLECULAR NMR EXPERIMENTS.....</u>	250

BRUKER Pulse Program Catalogue

written by Teodor Parella

This catalogue presents the pulse sequence diagram for all standard pulse programs included in TOPSPIN v2.0. This information is part of NMRGuide 4.1, also available for BRUKER AVANCE spectrometers.

These pulse programs are located in the

/TOPSPINHOME/pp/stan/nmr/lists/pp

directory after conventional installation using **expinstall** and they can be visualized directly into the TOPSPIN program from the PulsProg section. Otherwise, alternative pulse program sequence representation is also available using the **showpp** program.

For more details on pulse programs, parameter sets, tutorials, experiment descriptions, bibliographic references and other related information, please refer to the electronic version of NMRGuide 4.1.



INDEX NMRGuide Home | About ... | Wizards | Encyclopedia | Tutorials | Library | Documentation

Pulse Program by alphabetical order: A | B | C | D | E | F | G | H | I | J | K | L | M | N | O | P | Q | R | S | T | U | V | W | X | Y | Z | - all

BRUKER'S LIBRARY
Pulse Programs

Nomenclature of Parameters
Nomenclature of Pulse Programs
About Last Changes ...

Pulse Program Reference Manual

1D Experiments	2D Homonuclear	2D Heteronuclear	2D Inverse and Gradients
¹H	Homonuclear	X-detected	from f2 channel
Solvent Suppression	Homonuclear in H ₂ O	Inverse	from f3 channel
Selective Excitation	Homonuclear & Gradients	from f2 channel	2D TROSY
Selective	Gradients in H ₂ O	from f3 channel	from f2 and f3 channel
Selective & Gradients	Band-Selective Homonuclear		Relaxation from f3 channel
			Inverse X-filtered
X-detected			
Inverse			nJCH Measurement
Inverse & Gradients			
Miscellaneous			
3D Experiments	3D Miscellaneous	Miscellaneous	Include Files
Triple-Resonance	Homonuclear	L-C-NMR	Avance.incl
Backbone	Double-Resonance	Calibration & Tests	Delay.incl
Backbone-Side chain	from f2 channel	Solid-State	Daz.incl
² H-decoupled	from f3 channel	Diffusion	De.incl
Backbone	3D NOE	¹⁹ F	Grad.incl
Backbone-Side chain	X-filtered/edited	² H	Solids.incl
TROSY	Coupling Constants	Nucleic Acids	Sysconf.incl
Backbone	Coupling Constants		
Backbone-Side chain			
² H-decoupled			

INDEX

[Home](#) | [About ...](#) | [Wizards](#) | [Encyclopedia](#) | [Tutorials](#) | [Library](#) | [Documentation](#)

AVANCE Tutorials

NMR Assistance

Step 1: Is the Spectrometer Ready?
 Installation & Configuration (**cf** & **expinstall**)
 Tests & Calibrations (**edprosol**)
 Defining the probe (**edhead**)

Step 2: Preliminary Set-up
 About Sample Preparation
 Insert the sample (**ij/ej**)
 Select the solvent (**lock**)
 Tuning & Matching ... (**wobb**)
 Shimming ... (**rsh** ...)

Step 3: Data Acquisition (eda)
 Create a new file (**edc**)
 Read Parameter Set (**rpar** ...)
 Set Pulses (**getprosol**)
 Modify parameters (**ased**)
 Start Acquisition (**rga** & **zg**)

Step 4: Data Processing (edp)
 Transforming the data (**ft, xfb** ...)
 Phase correction (**apk**)
 Baseline correction (**abs**)
 Plot (**edg, xwinplot**)

Step 5: Automation ...
 Using macros ... (**edmac**)
 Using **iconumr** ... (**Biotool**)
buttonmr & **butselmr**
 AU Programs (**xau**)

Step 6: Deciding what to do?
 Which experiments can I do ...
 Starting **Parameter Set...**
 Routine NMR experiments
 Interpreting the spectra...



NMRGuide

NMR Experiment Map

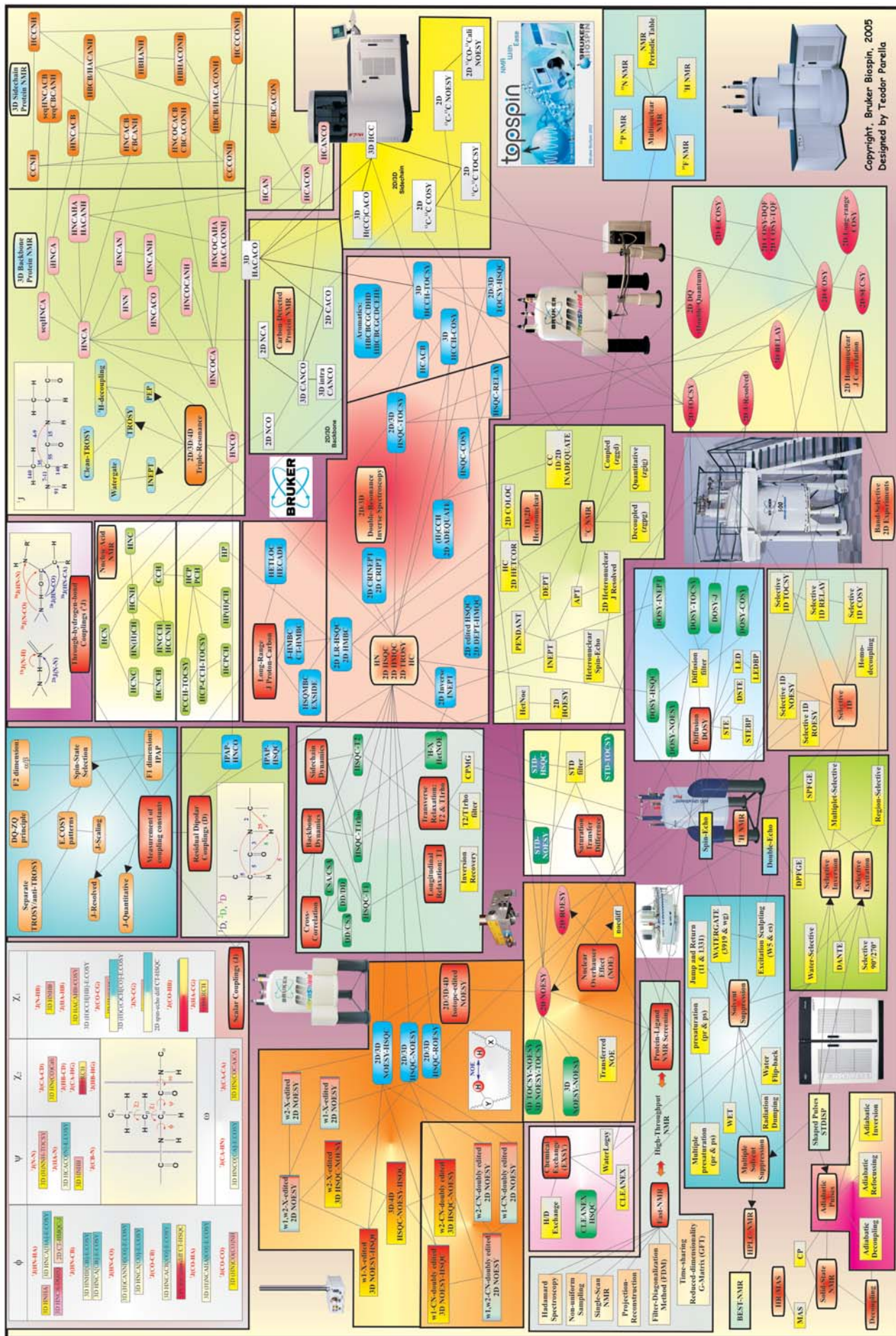

Copyright, Bruker Biospin, 2005
Designed by Teodor Parella

BRUKER PULSE PROGRAM CATALOGUE

NMRGuide

BASIC 1D PULSE SEQUENCES

• **Standard Experiments:**

Conventional ^1H spectrum (**zg30** / **zg** / **zg0** | PROTON)
Acquired as 2D (**zg2d**)

1D ^1H Homodecoupling (**zg0hd** / **zghd** / **zghd.2** | PROHOMODEC)
1D ^1H Band-selective homodecoupling (**zghc** / **zghc.2**)
NOEDIFF experiment:
Single irradiation (**zgf2pr**)
Using frequency list (**noediff** / **noediff.2** / **noedif.2** | NOEDIFF)
Irradiation multiplet frequencies within one multiplet (**noemul**)

^{13}C spectrum with selective ^1H decoupling using CW (**zgcw30** / **zgcw** / **zg0cw**)
 ^1H -decoupled ^{13}C spectrum (**zgcd30** / **zgcd** / **zg0dc** | C13CPD)
 ^1H -coupled ^{13}C spectrum (**zggd30** / **zggd** / **zg0gd** | C13GD)
 ^1H -decoupled ^{13}C spectrum without NOE (**zgif30** / **zgif** / **zg0ig** | C13IG)
 $^1\text{H}, ^{31}\text{P}$ -decoupled ^{13}C spectrum without NOE (**zgfbig**)

Antiring sequence (**aring**, **aring2**)
1D sequence for suppression of background signals using composite pulse (**zgsb**)

• **Examples:**

^{31}P -decoupled 1D ^1H spectrum (**zgif30** / **zgif** | PROP31DEC)
 ^{11}B -decoupled 1D ^1H spectrum (**zgif30** / **zgif** | PROB11DEC)

^1H -decoupled ^{15}N spectrum without NOE (**zgif** / **zgf3ig** | N15IG)
 ^1H -coupled ^{15}N spectrum without NOE (**zg** | N15)

^1H -decoupled ^{31}P spectrum (**zpgp30** | P31CPD)
 ^1H -coupled ^{31}P spectrum (**zg30** | P31)

• **Standard BRUKER parameter sets available for other nuclei:**

1D ^{11}B spectrum (**zg** | B11ZG)
1D ^{17}O spectrum (**zg** | O17ZG)
1D ^{23}Na spectrum (**zg** | NA23ZG)
1D ^{27}Al spectrum (**zg** | AL27ND)
1D ^1H -decoupled ^{29}Si spectrum (**zgif** | si29IG)
1D ^{35}Cl spectrum (**zg** | CL35ZG)
1D ^{37}Cl spectrum (**zg** | CL37ZG)
1D ^{71}Ga spectrum (**zg** | GA71ZG)
1D ^{71}Ga spectrum (**zg** | SE77ZG)
1D ^{103}Rh spectrum (**zg** | RH103ZG)
1D ^{111}Cd spectrum (**zg** | CD111ZG)
1D ^{113}Cd spectrum (**zg** | CD113ZG)
1D ^1H -decoupled ^{119}Sn spectrum (**zgif** | SN119IG)
1D ^{195}Pt spectrum (**zg** | PT195ZG)
1D ^{199}Hg spectrum (**zpgp** | HG199CPD)

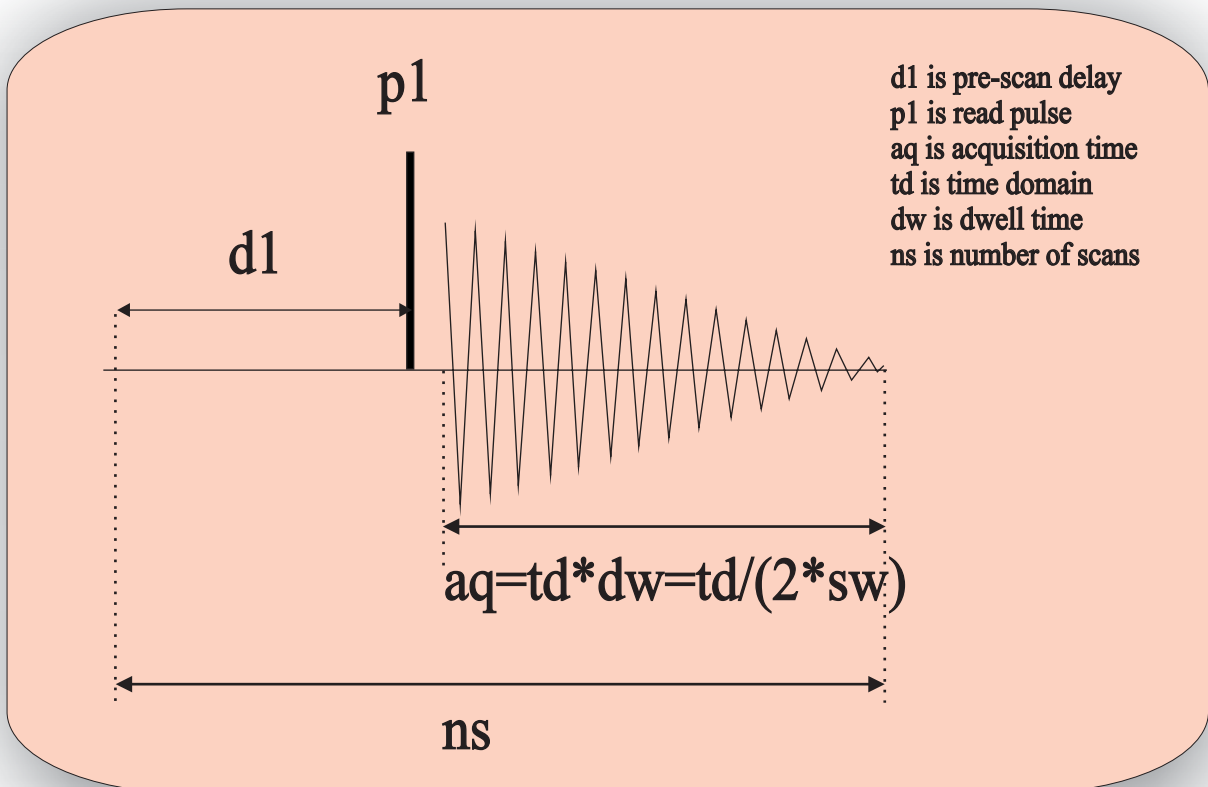
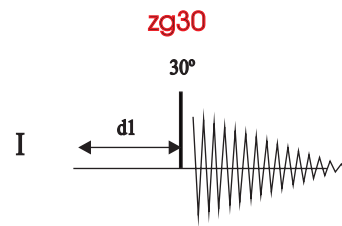
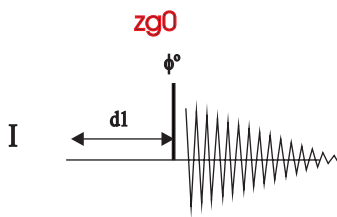
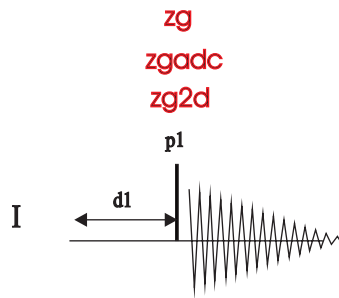

zghc
 zghc.2
 zghd.2
 zghd

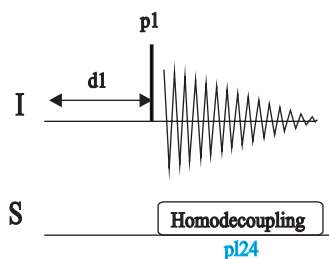

zg0hd

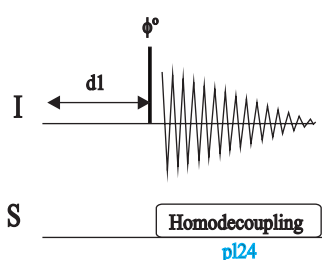

zgadchd

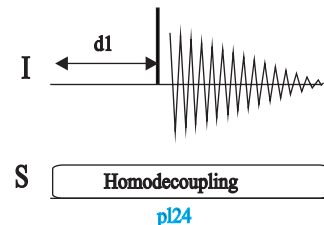

d1=3
 p124=40
 o2p=1.29(H-13)
 pulprog=zghd.2

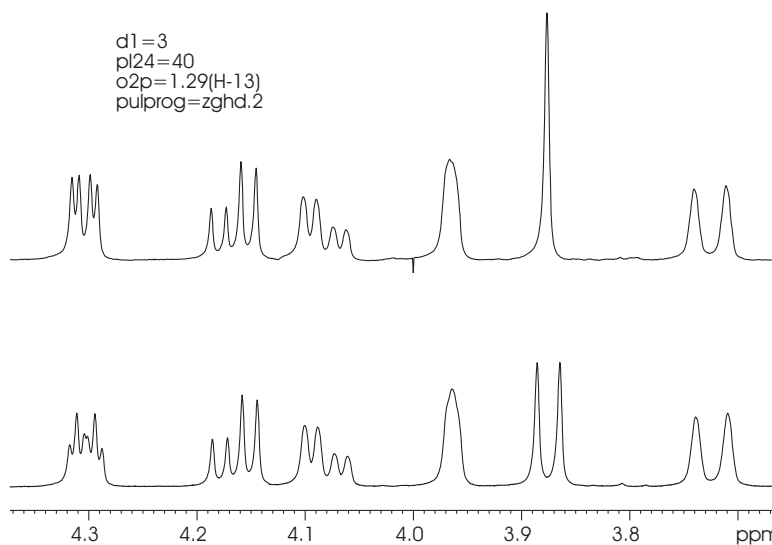

zgcw

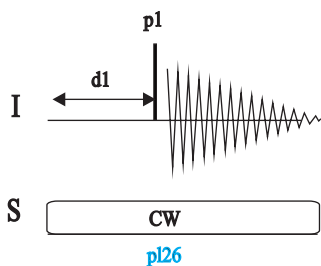

zg0cw

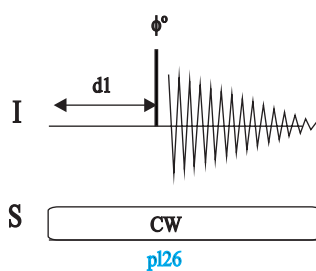

zgcw30

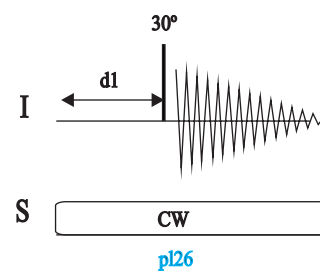

noedlf.2 noediff
 noemul noediff.2

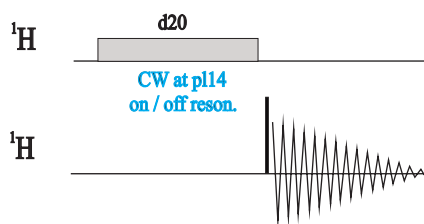

Also see: solvent suppression
 (zgf2pr)

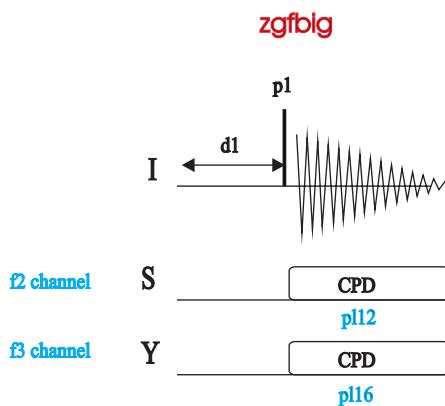
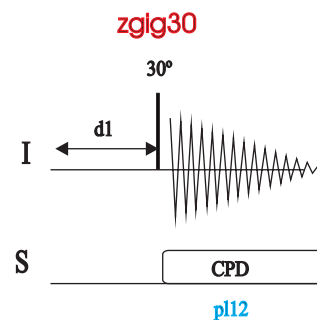
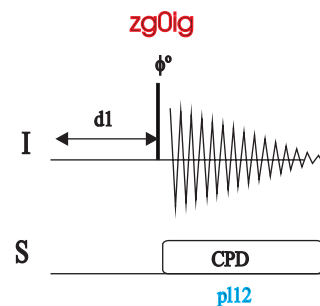
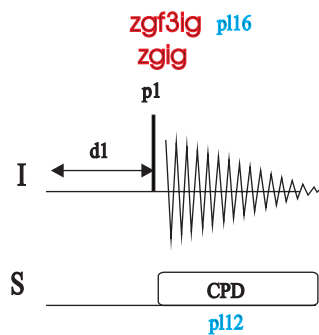
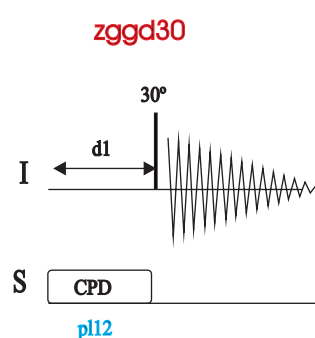
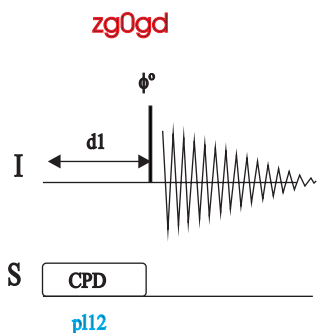
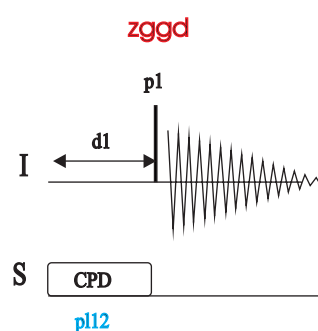
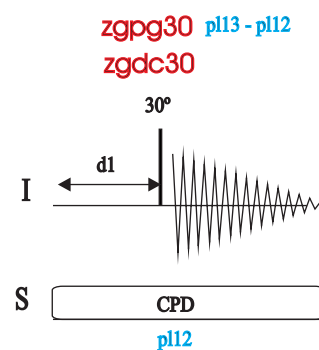
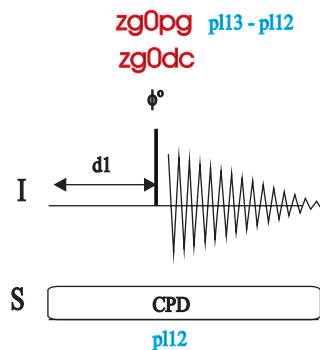
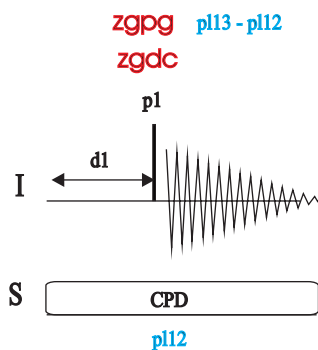

zgbs

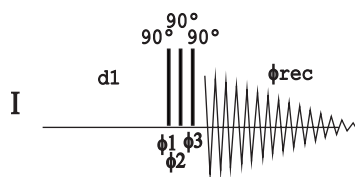

aring

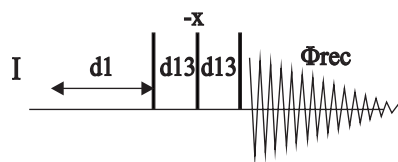

aring2

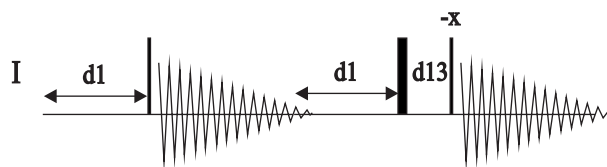

BRUKER PULSE PROGRAM CATALOGUE

NMRGuide

T1 & T2 RELAXATION

¹H T₂ measurements
 As 1D acquisition (**cpmg1d**)
 As 2D acquisition (**cpmg**)
 As 1D acquisition with presaturation (**cpmgpr1d**)

¹H T₁ measurements:
 As 1D acquisition (**t1ir1d**)
 As 2D acquisition (**t1ir** || **PROTONT1**)

T₁ ¹³C measurements (**t1irpg**)

Also see: 2D HSQC for Backbone Dynamics

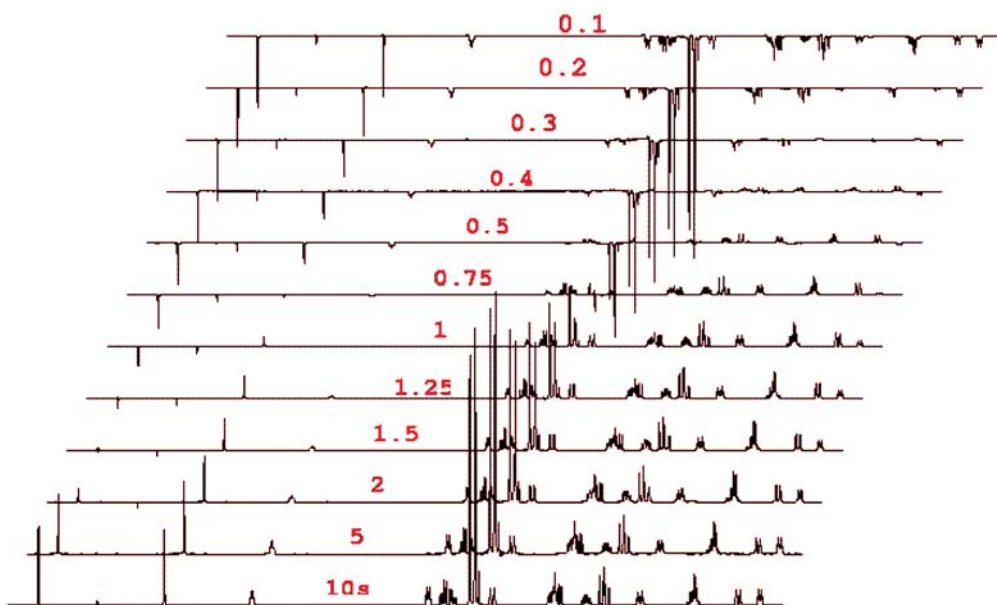
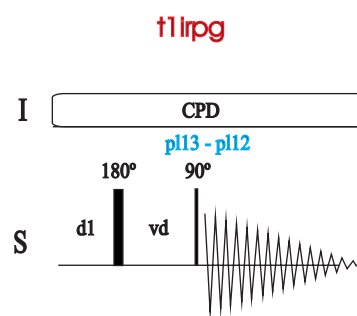
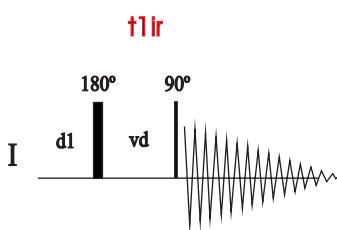
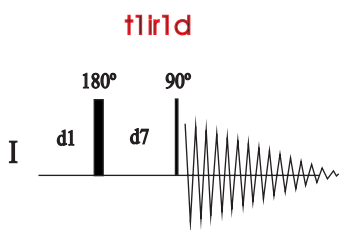

$$I_z = I_0(1 - 2\exp(-d7/T_1))$$

↓

$$\ln(I_0 - I_z) = \ln(2I_0) - d7/T_1$$

$$t_{null} = T_1 * \ln 2$$

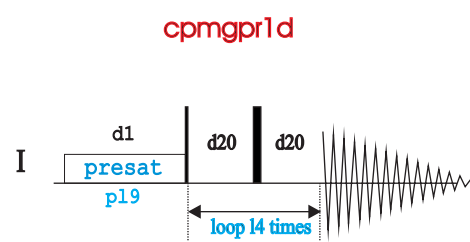
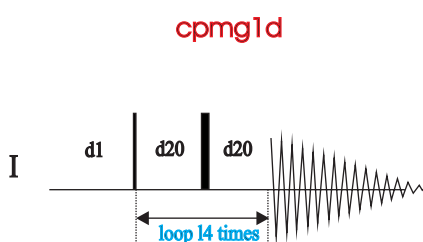
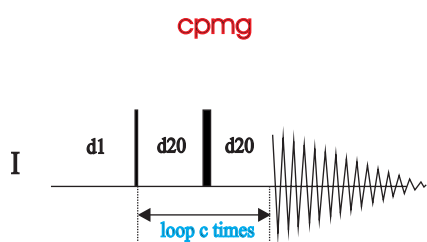

BRUKER PULSE PROGRAM CATALOGUE

NMRGuide

SELECTIVE EXCITATION &
SELECTIVE 1D EXPERIMENTS

• **Phase-Cycled:**

Using a shaped 90° pulse (**selzg** | **SELZG1H**)
Selective 1D COSY experiment (**selco** | **SELCO1H**)
Selective 1D RELAY experiment (**selcorl**)
Selective 1D TOCSY experiment (**selmlzf** | **SELMLZFIH**)
Selective 1D NOESY experiment (**selno** | **SELNO1H**)
Selective 1D ROESY experiment (**selro** | **SELRO1H**)

• **Gradient-based:**

Using selective pulsed-field-gradient spin-echo or SPFG (selgpse | SELGPSE)
Selective ge-1D COSY experiment (**selcogp** | **SELCOGP**)
Selective ge-1D TOCSY experiment:
 using MLEV (**selmlgp** | **SELMLGP**)
 using MLEV With ZQ suppression (**selmlgp.2**)
 using DIPSI-2 (**seldigp**)
Selective ge-1D NOESY experiment (**selnogp** | **SELNOGP**)
Selective ge-1D ROESY experiment (**selrogp** | **SELROGP**)
Selective ge-1D T-ROESY experiment (**selrogp.2**)

• **¹³C Selective:**

¹³C Selective excitation using a shaped 90° pulse (**selzpgp**)
Selective 1D X-X COSY experiment (**selcogp**)
Selective 1D INADEQUATE experiment (**selina**)

• **Miscellaneous:**

2-2-6-2-2 DANTE-z scheme (**dazzg**)
3-6-3 DANTE-z scheme (**daz363zg**)
1-1 DANTE-z scheme (**daz11zg**)

selzg

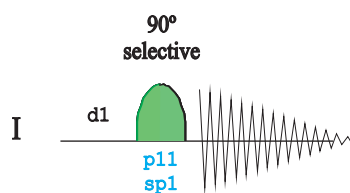

selco

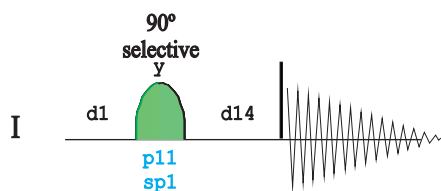

selcor1

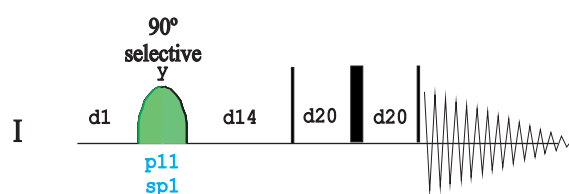

selm1zf

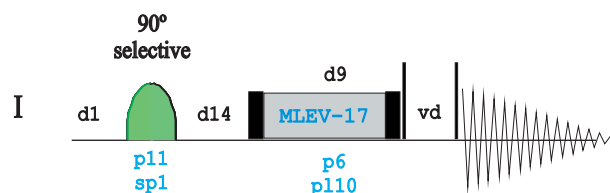

selro

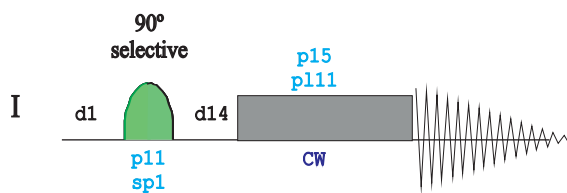

selno

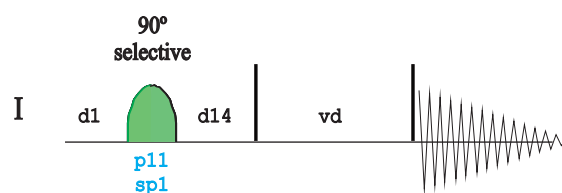

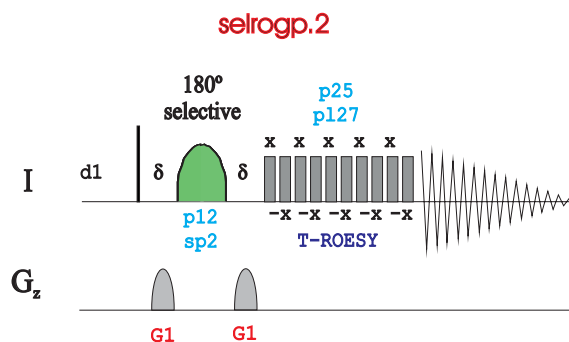
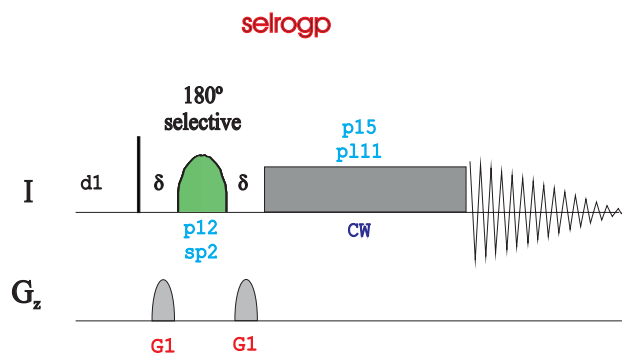
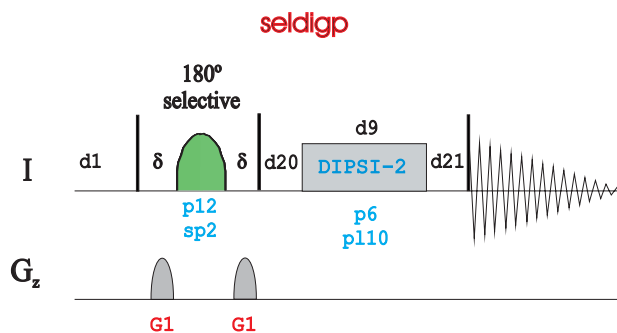
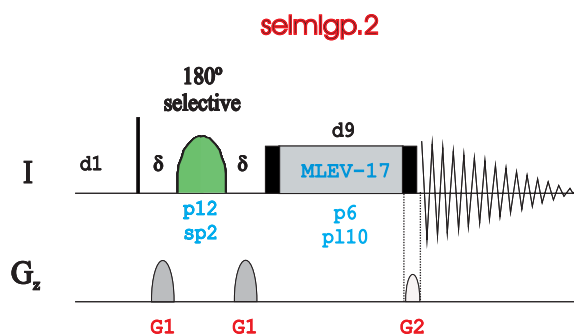
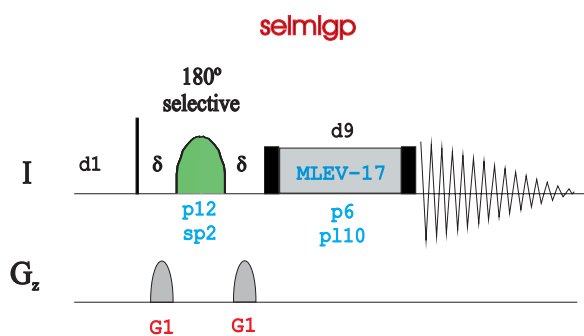
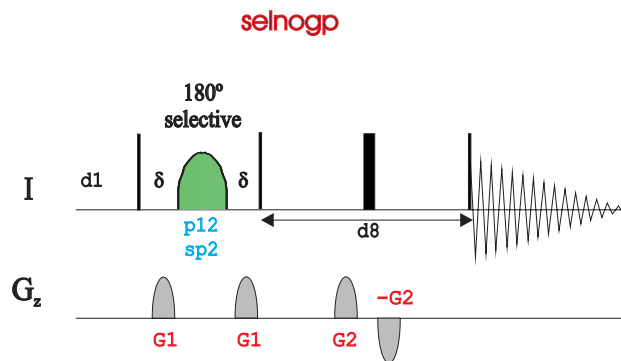
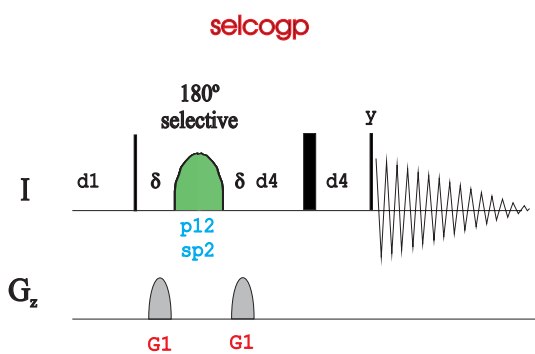
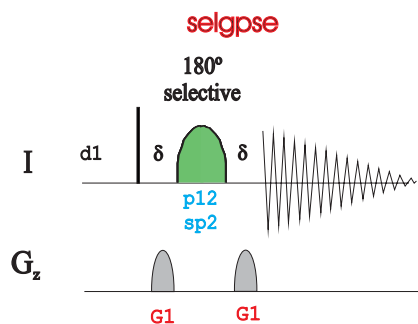

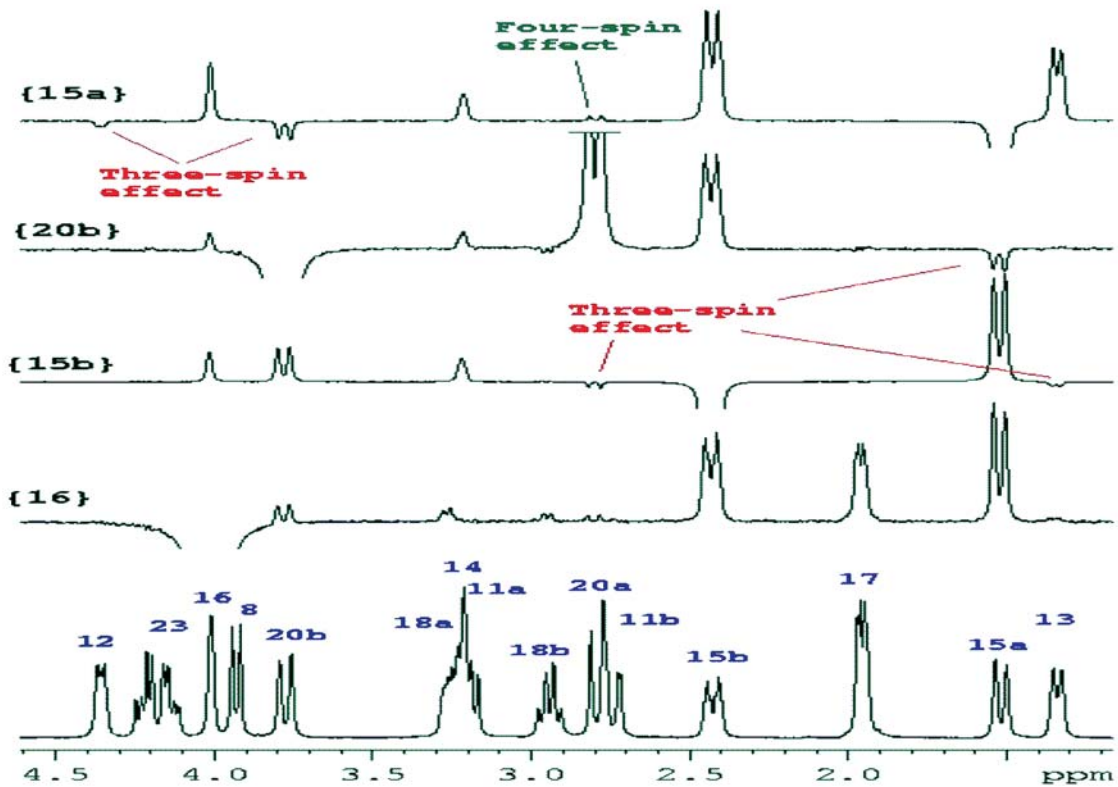
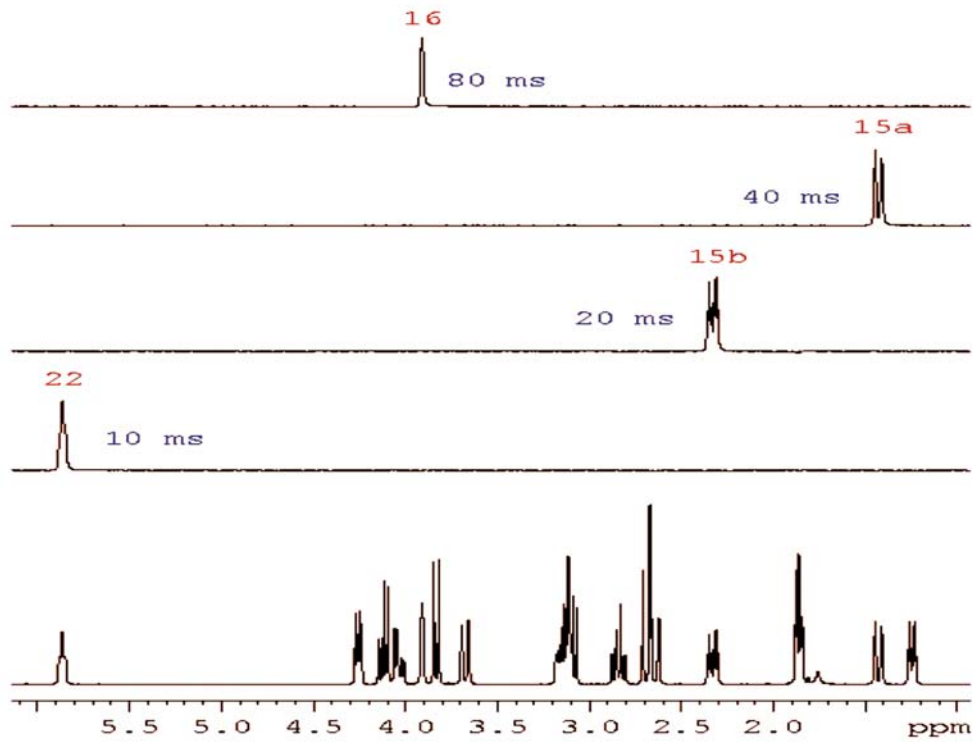

selzpgg

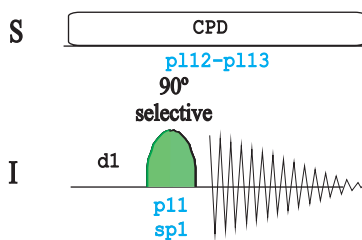

selcpgg

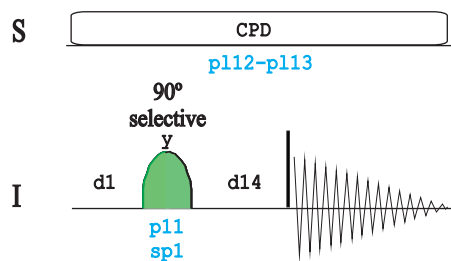

selina

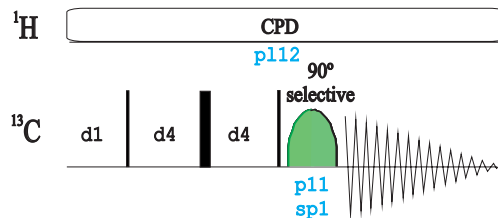

dazzg

daz11zg

daz363zg

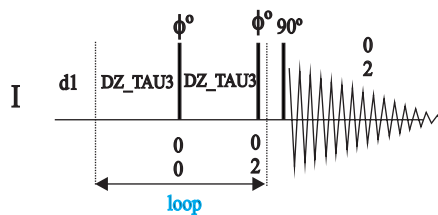

BRUKER PULSE PROGRAM CATALOGUE

NMRGuide

1D SOLVENT SUPPRESSION

1D Solvent suppression

Classical:

1D water presaturation:

- Conventional (**zgpr** / **zg0pr** | **ZGPR**)
- Using composite pulses (**zgcppr** | **ZGCPPR**)
- Using spoil gradient (**zggppr**)
- Using composite pulse and spoil gradient (**zgcpgppr**)
- From f2 channel (**zgf2pr** / **zg0f2pr**)
- Using shaped pulse for off-resonance presaturation (**zgps**)

Jump and return:

- 1-1 scheme (**p11**)
- 1-3-3-1 scheme (**p1331**)

Gradient-based:

1D WATERGATE:

- Using 3-9-19 scheme (**p3919gp** | **P3919GP**)
- Using 3-9-19 and flip back pulse (**p3919fpgp**)
- Using 90° water-selective pulses (**zggpwg** | **ZGGPWG**)

1D Excitation Sculpting:

- Using 180° water-selective pulses (**zgesgp**)
- Using 180° water-selective and flip back pulse (**zgesfpgp**)
- Using W5 pulse train (**zggpw5**)

1D WET scheme:

- Conventional (**wet**)
- With ¹³C decoupling on f2 during WET and AQ (**wetdc** | **LC1DWTDC**)
- With ¹³C decoupling on f2 during WET (**wetdw**)

Related Experiments:

- All these 1D experiments can be incorporated in any multidimensional NMR experiment. Please refer to each chapter to check the different possibilities for 2D and 3D solvent-suppressed experiments
- LC-NMR Experiments

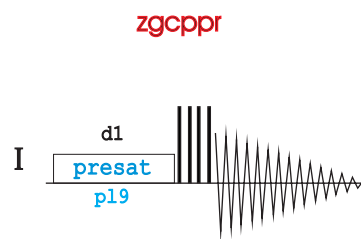
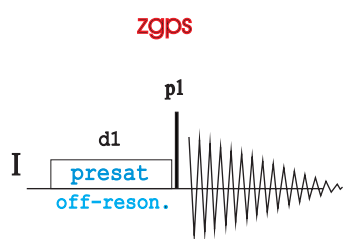
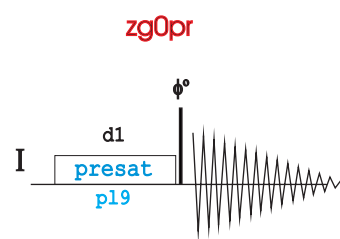
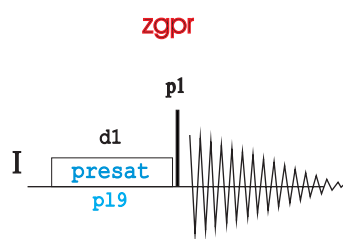

Also see: LC-NMR experiments

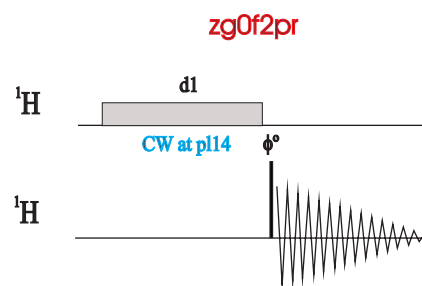
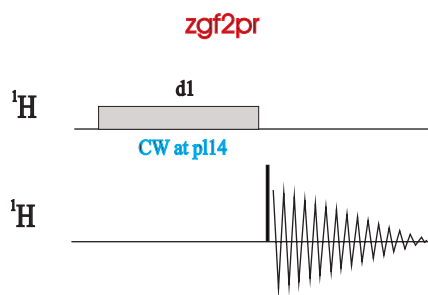
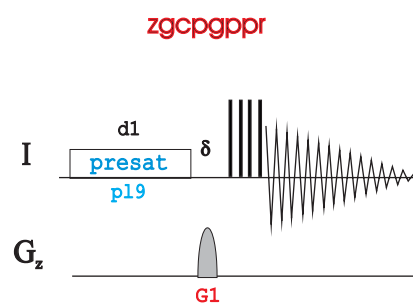
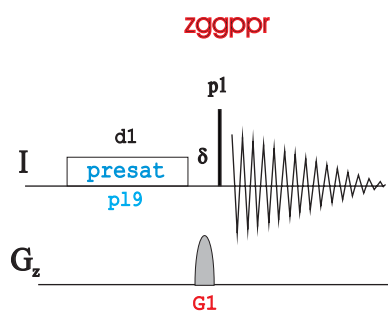

Also see: noediff

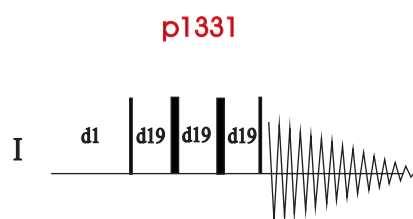
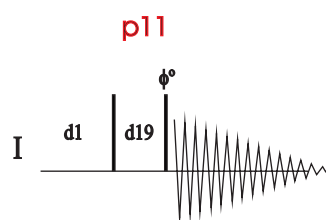

p3919gp

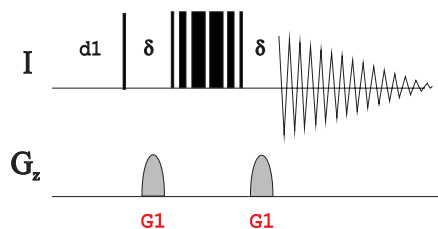

p3919fpgp

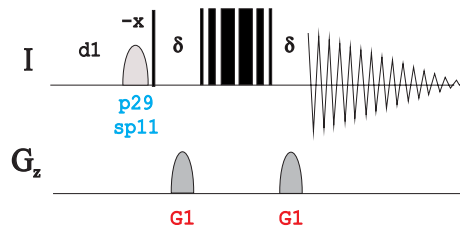

zggpwg

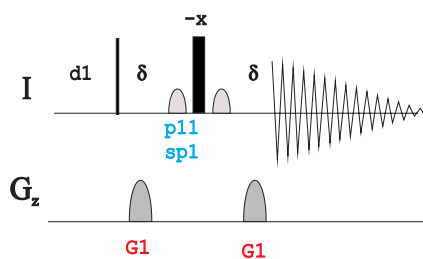

zggpw5

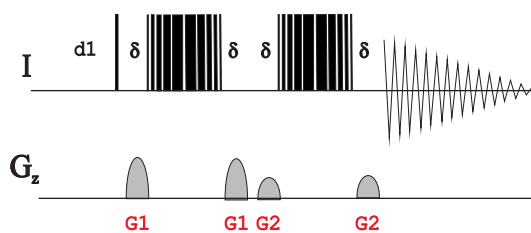

zgesgp

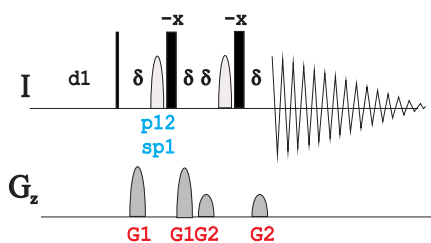

zgesfpgp

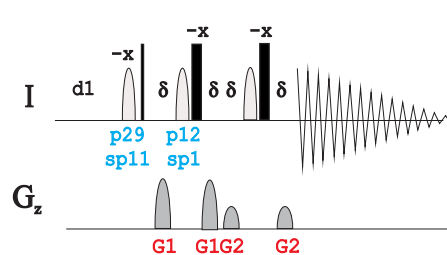

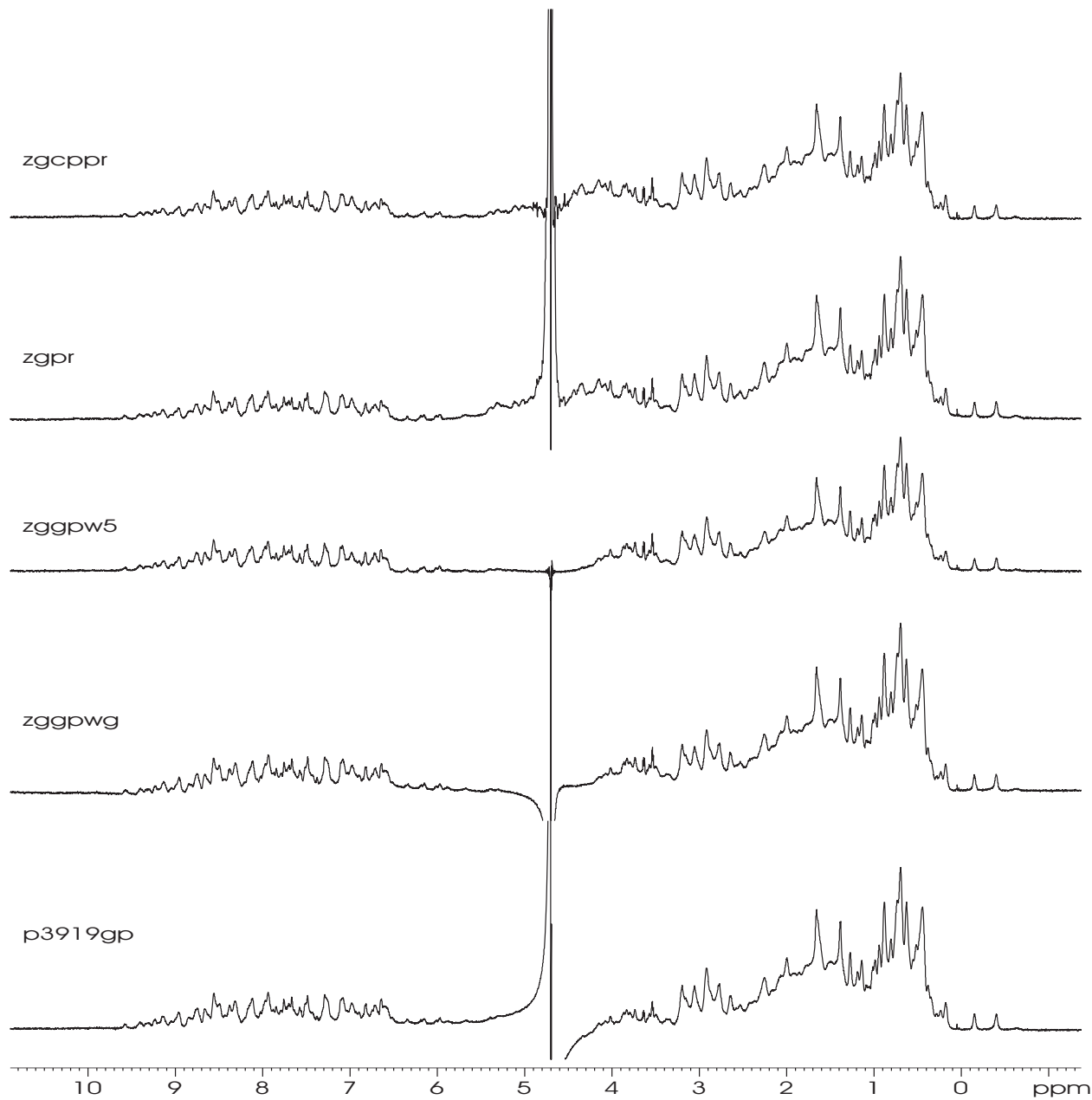

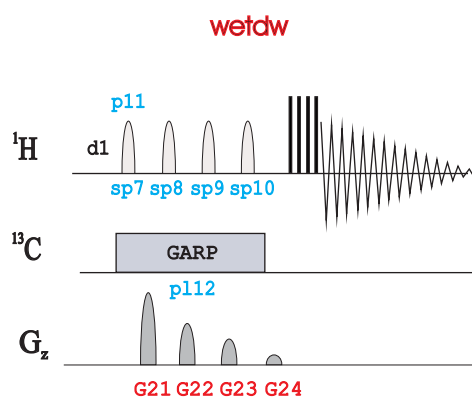
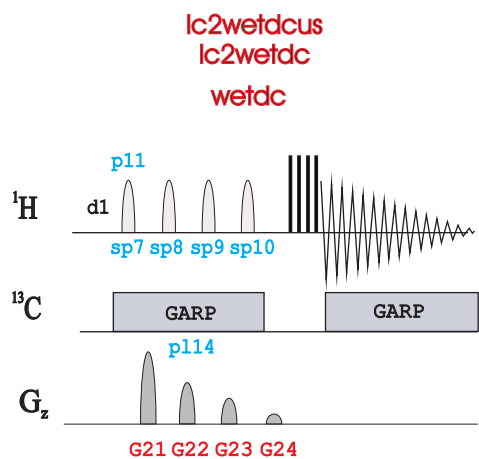
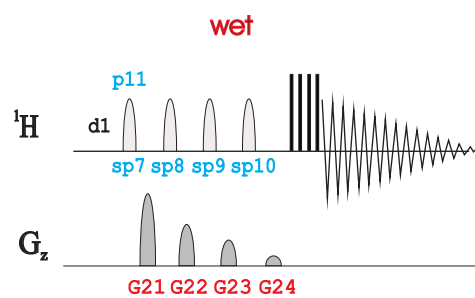

BRUKER PULSE PROGRAM CATALOGUE

NMRGuide

¹⁹F SPECIFIC EXPERIMENTS

¹⁹F Experiments

1D spectra:

¹H-decoupled ¹⁹F spectrum (**zgfhiqan** / **zgfhiqan.2** | F19CPD)

¹H-coupled ¹⁹F spectrum (**zgflqn** | F19)

¹⁹F-homodecoupled ¹⁹F spectrum (**zhflhdqn**)

¹⁹F-decoupled 1D ¹H spectrum (**zghfiqan** / **zghfiqan30** | PROF19DEC)

¹H spectrum with ¹⁹F-presaturation (**zgf2hfpr**)

2D spectra:

2D ¹⁹F-¹H HETCOR experiment (**hfcoqfqn**)

2D ¹⁹F-¹H HOESY experiment (**hoesyfhqfqnrv**)

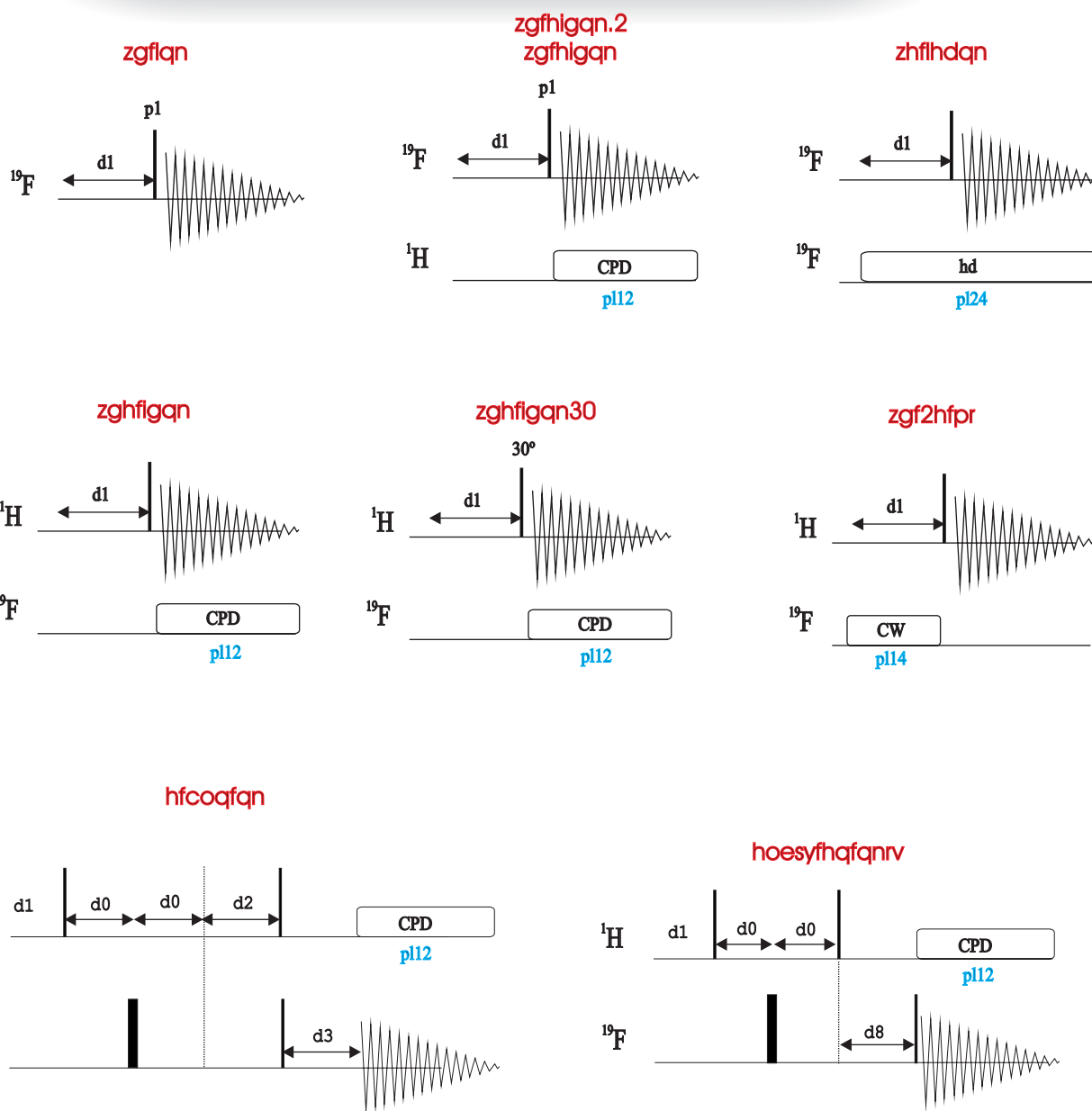

BRUKER PULSE PROGRAM CATALOGUE

NMRGuide

^2H SPECIFIC EXPERIMENTS

- **1D spectra:**

1D ^2H spectrum (**zg2h**)

1D X-decoupled ^2H spectrum (**zgig2h, zgig2hf4**)

- **2D spectra:**

Magnitude-mode 2D HETCOR with ^2H -decoupling (**hxcoqf2h**)

- **Miscellaneous:**

High-power 90° ^2H decouple pulse calibration (**decp902h, decp902hf4**)

Related Experiments:

- Also see: ^2H -decoupled 3D triple-resonance experiments

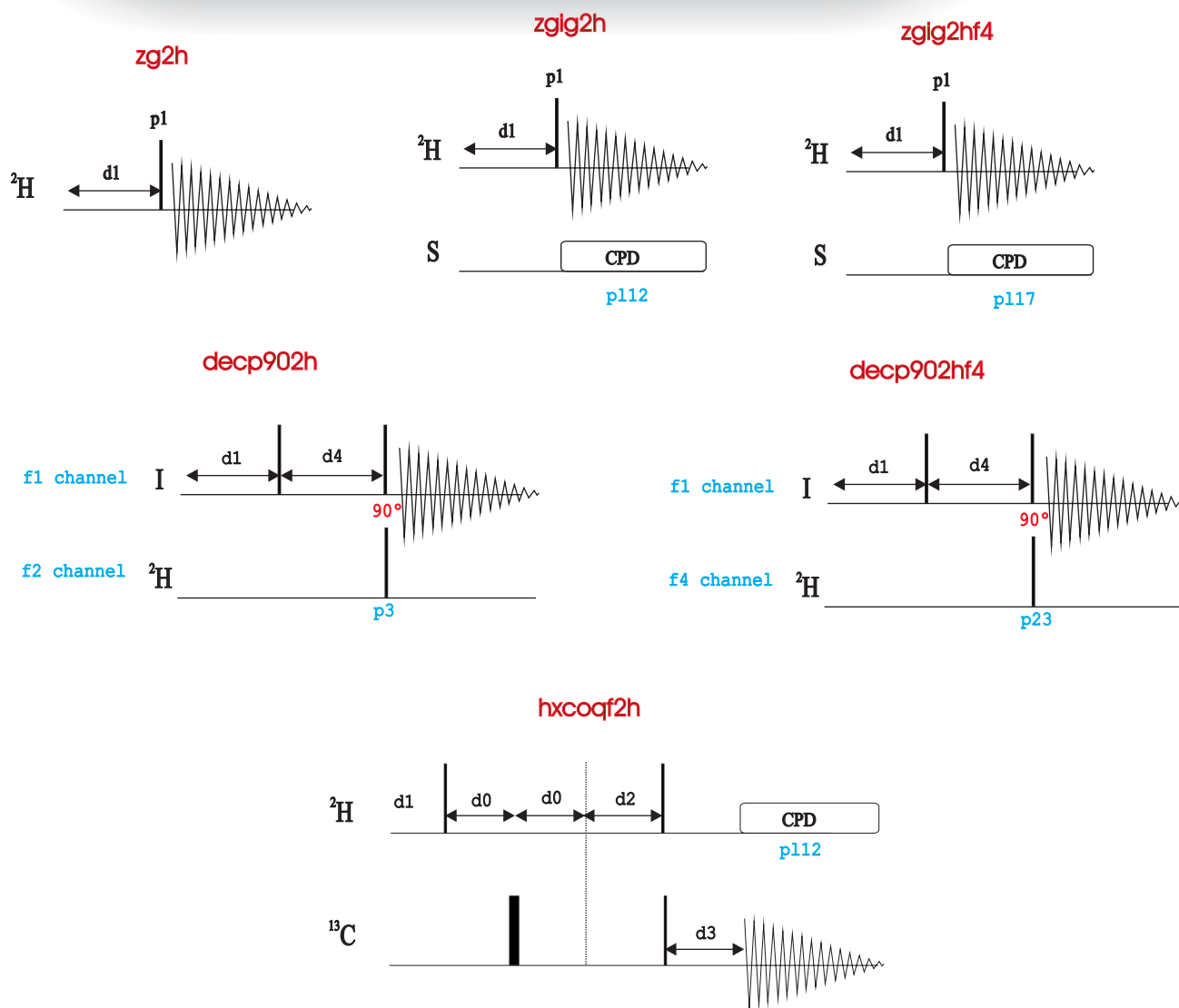

BRUKER PULSE PROGRAM CATALOGUE

NMRGuide

BASIC 1D GRADIENTS

- **Standard:**

Gradient-enhanced 1D Echo experiment (**zggeg**)
 Gradient-enhanced 1D Spin-Echo experiment (**zggpse**)

- **Gradient Calibration:**

Gradient Strength Calibration (**calibgp**)
 Gradient Preemphasis Adjustment. Gradient Recovery Test (**preempgp2**)

- **Gradient shimming:**

1D Gradient Echo for gradshim-procedure (**imgegp1d**)
 1D Gradient Echo for gradshim-procedure using 2H (**imgegp1d2h**)
 1D Gradient Echo for gradshim-procedure using selective pulse (**imgegpsp1d**)

 3D Gradient Echo for gradshim-procedure (**imgegp3d**)
 3D Gradient Echo for gradshim-procedure with BSMS RCB board(**imrcbgegp3d**)

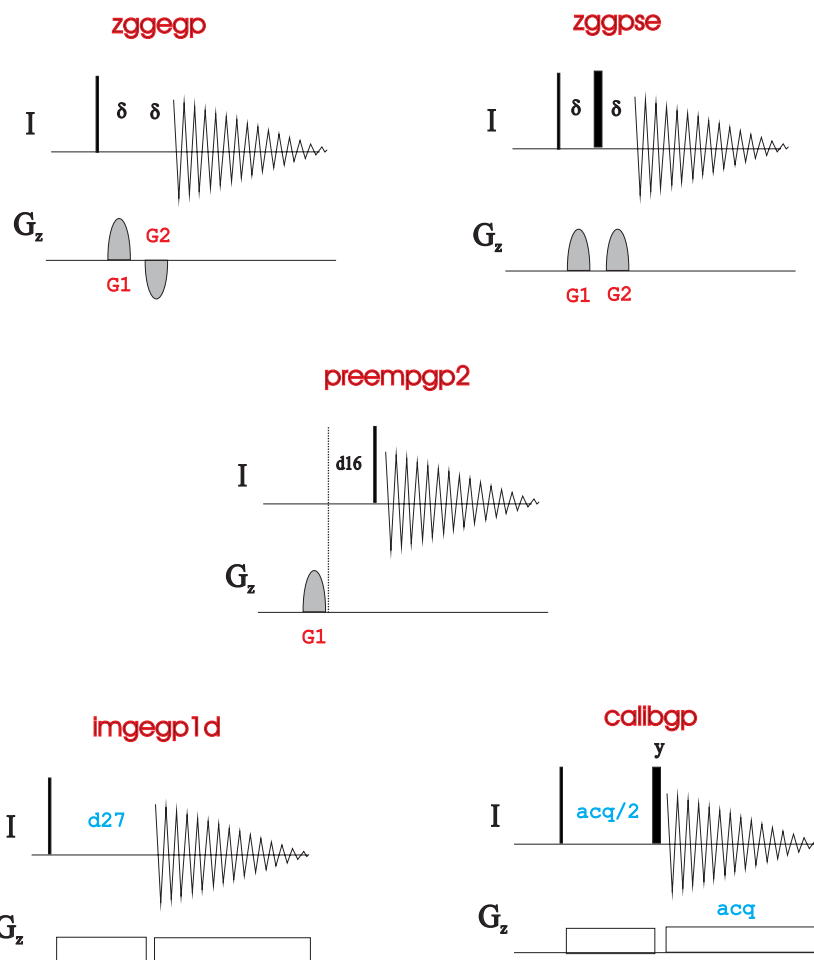

BRUKER PULSE PROGRAM CATALOGUE

NMRGuide

2D COSY EXPERIMENTS

Phase-cycled:

Magnitude-mode 2D COSY (**cosyqf** | **COSY45SW** / **COSY90SW**)
Magnitude-mode 2D COSY using a 45 pulse (**cosyqf45** | **COSY45SW**)
Magnitude-mode 2D COSY using a 90 pulse (**cosyqf90** | **COSY90SW**)
Magnitude-mode 2D COSY using purge pulses before d1 (**cosyppqf**)
Phase-sensitive 2D COSY (**cosyph**)

Magnitude-mode Long-Range optimized 2D COSY (**cosylrqf**)

Constant-Time 2D COSY (**cosyjdqf**)

Phase-cycled and solvent suppression:

Magnitude-mode 2D COSY with presaturation (**cosyprqf**)
Phase-sensitive 2D COSY with presaturation (**cosyphpr** | **COSYPHPR**)

Gradient-based:

Magnitude-mode ge-2D COSY (**cosygpqf** | **COSYGPSW**)
Magnitude-mode ge-2D COSY using purge pulses before d1 (**cosygpppqf**)
Phase-sensitive ge-2D COSY using echo-antiecho (**cosyetgp**)

Miscellaneous:

Phase-sensitive w_1 -region-selective 2D COSY (**scoyph**)
Phase-sensitive w_1 -region-selective 2D COSY with refocusing (**scoyphrd**)

Phase-sensitive 2D COSY with off-resonance single or multiple presaturation (**cosycwphps** | **COSYCWPHPS**)

Magnitude-mode 2D ^{13}C - ^{13}C COSY (**cosydcqf**)
Magnitude-mode long-range optimized 2D ^{13}C - ^{13}C COSY (**cosydclrqf**)
Phase-sensitive 2D ^{13}C - ^{13}C COSY (**cosydcph**)

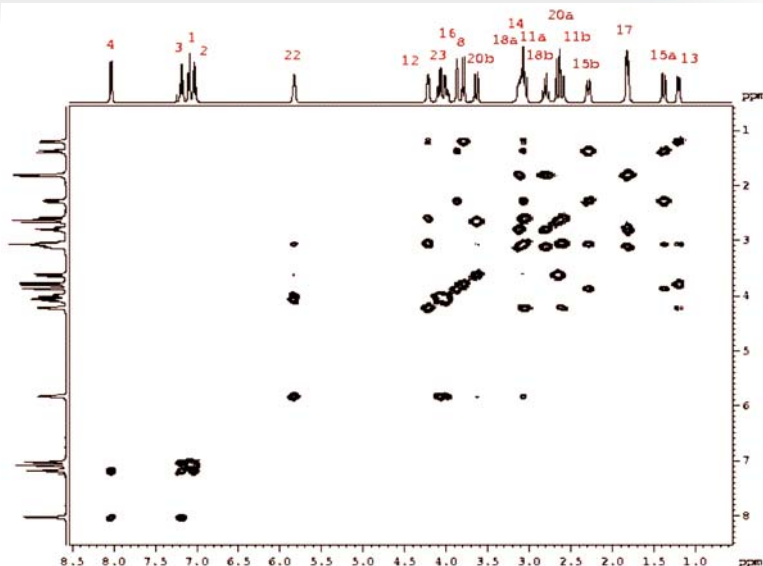

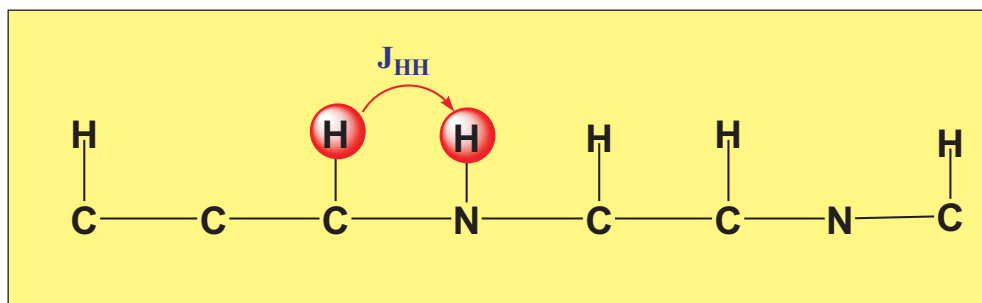

cosyph
 cosyqf

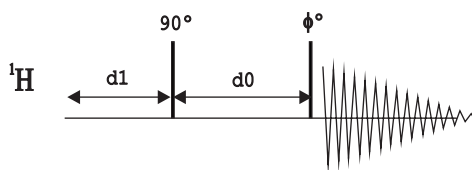

cosyqf45

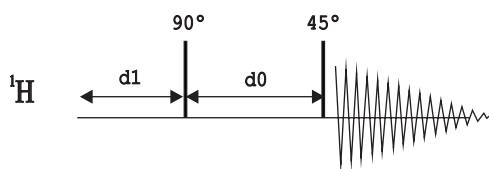

cosyqf90

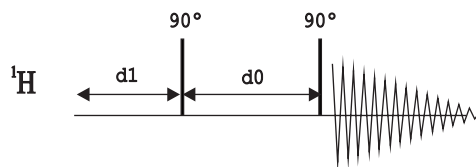

cosyppqf

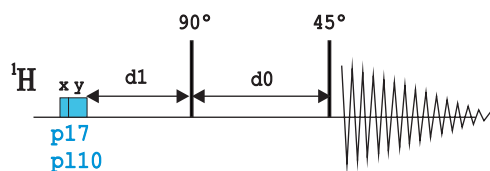

cosyphpr

cosyprqf

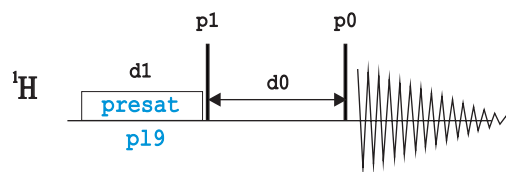

cosylrqf

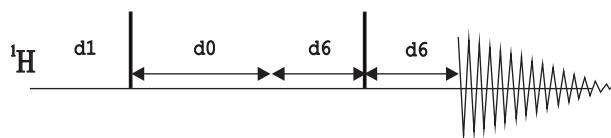

cosyjdqf

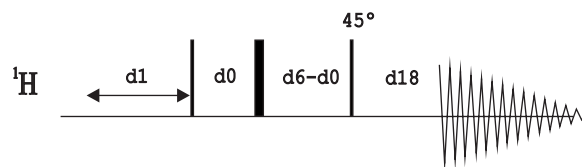

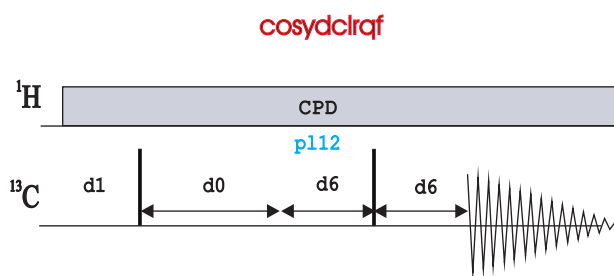
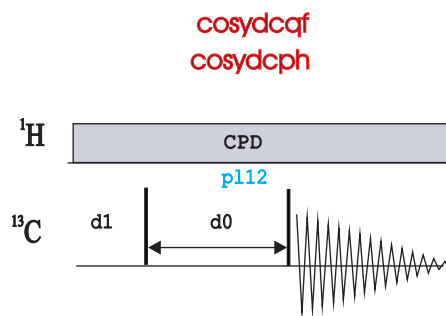
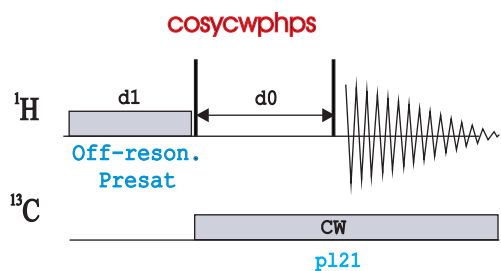
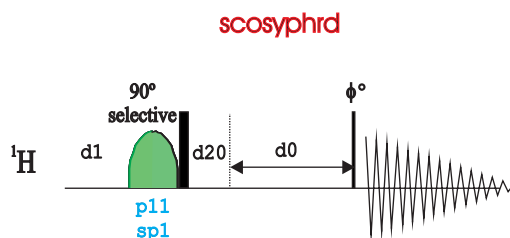
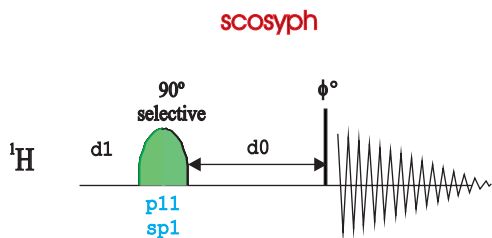
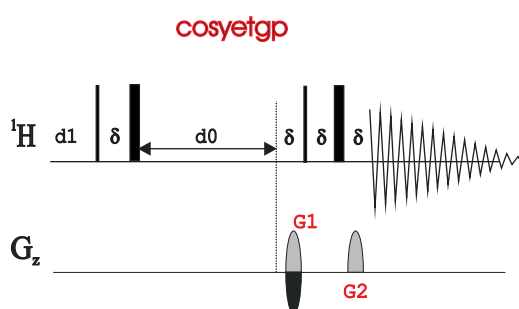
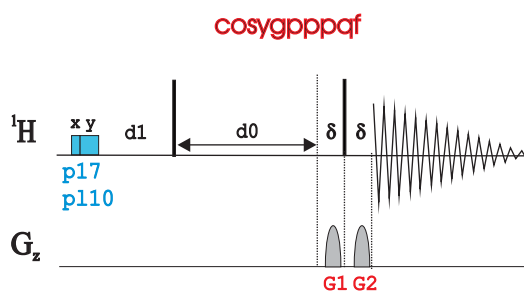
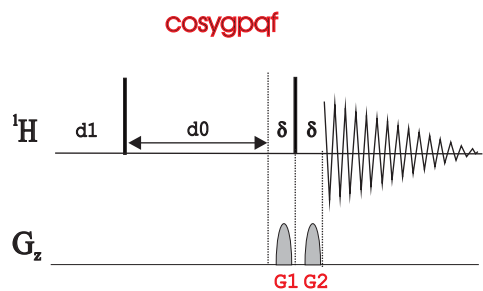

BRUKER PULSE PROGRAM CATALOGUE

NMRGuide

2D COSY-DQF EXPERIMENTS

• **Phase-cycled:**

Magnitude-mode 2D COSY with DQF (**cosydfqf**)
Magnitude-mode 2D COSY with TQF (**cosyqftf**)
Phase-sensitive 2D COSY with DQF (**cosydfph** | **COSYDQFPHSW**)
Phase-sensitive 2D COSY with TQF (**cosyptf**)

Phase sensitive 2D E.COSY -KcMAX=3 (**ecos3nph**)
Complementary Phase sensitive 2D E.COSY - KcMAX=3 (**ecos3cph**)

• **Phase-cycled and solvent suppression:**

Phase-sensitive 2D COSY with DQF & presaturation (**cosydfphpr**)

• **Gradient-based:**

Magnitude-mode ge-2D COSY with multiple-quantum filter (**cosygpmpfqf** | **COSYGPMPFSW**)
Phase-sensitive ge-2D COSY with multiple-quantum filter (**cosygpmpfh** | **COSYGPDPFPHSW**)
Phase-sensitive ge-2D COSY with DQF using echo-antiecho (**cosydfetgp.1**)
Phase-sensitive ge-2D COSY with gradient-based DQF using echo-antiecho (**cosydfetgp.2**)
Gradient E.COSY (**ecosygpqh**)

• **Gradient-based and solvent suppression:**

Phase-sensitive 2D COSY-DQF with WATERGATE using 3-9-19 (**cosydfgpph19**)
Phase-sensitive 2D COSY-DQF with Excitation Sculpting using 180 water-selective pulse (ES element) (**cosydfesgpph**)

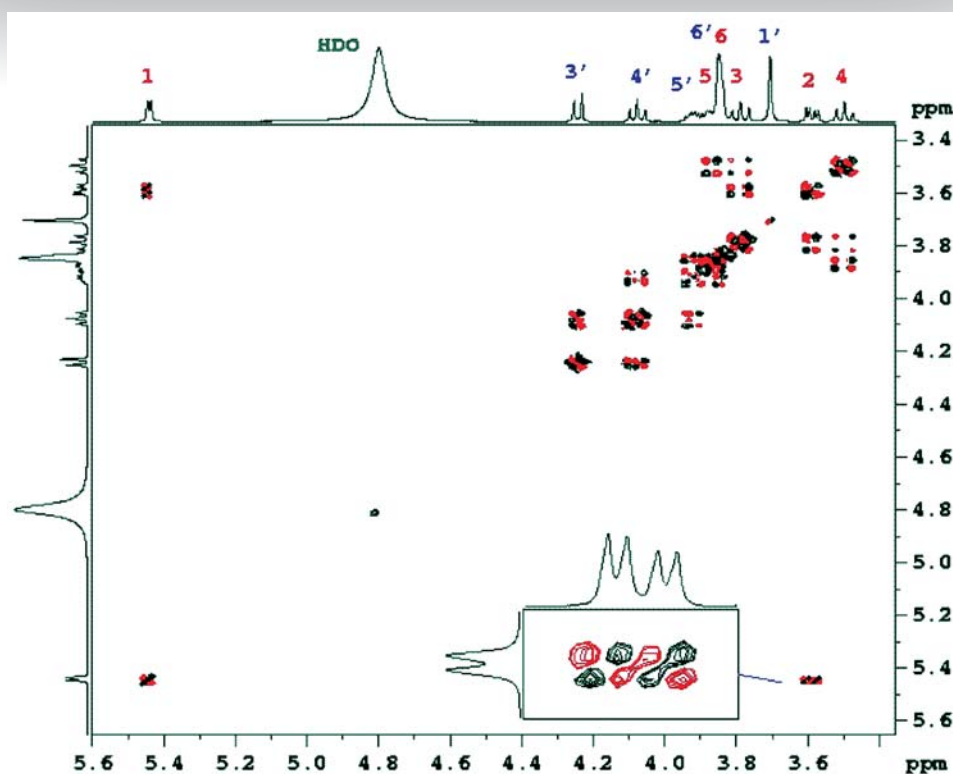

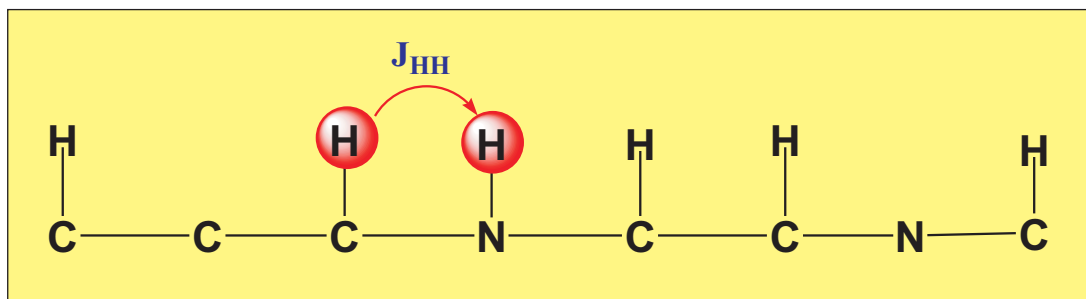

cosydfph cosyphf ecos3cph
 cosydfqf cosyqff ecos3nph

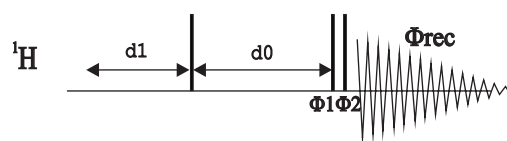

cosydfphpr

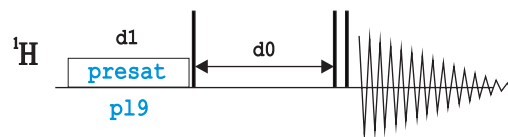

ecosygpph

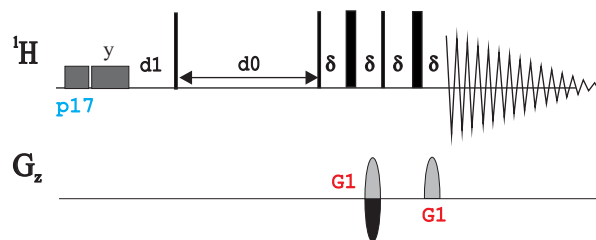

cosygpmfqf

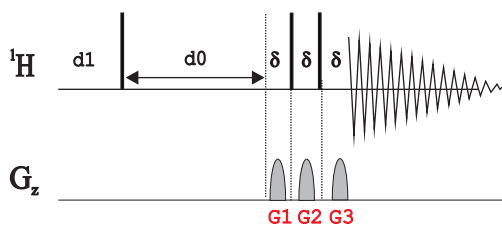

cosygpmfph

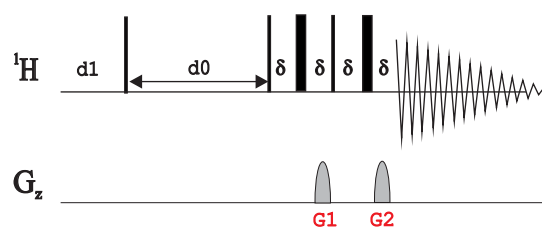

cosydfetgp.1

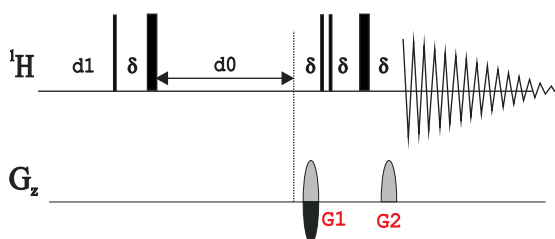

cosydfetgp.2

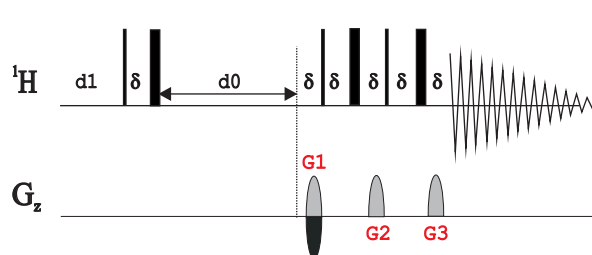

cosydfgpph19

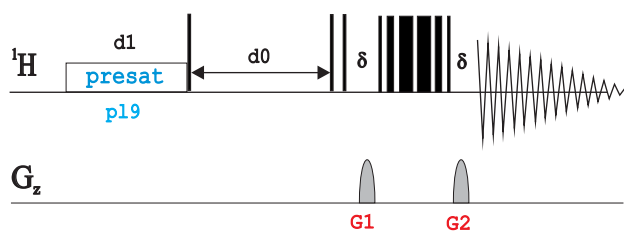

cosydfesgpph

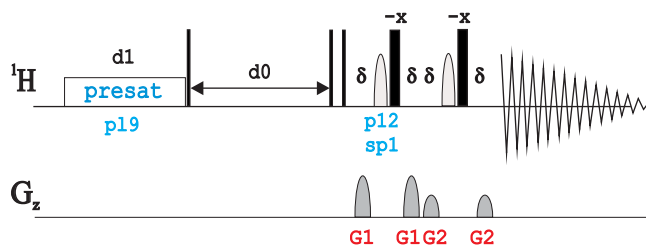

BRUKER PULSE PROGRAM CATALOGUE

NMRGuide

2D SECSY EXPERIMENTS

Magnitude-mode 2D SECSY (**secsyqf**)
Magnitude-mode long-range optimized 2D SECSY (**secsylrqf**)

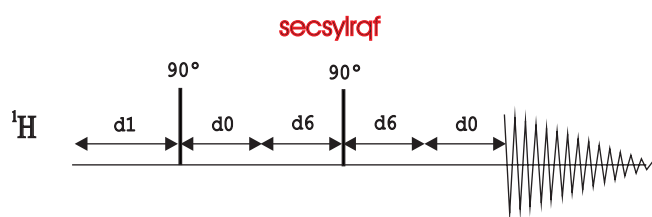
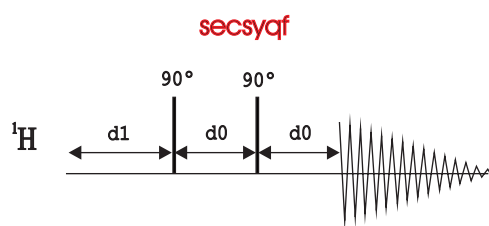

BRUKER PULSE PROGRAM CATALOGUE

NMRGuide

2D RELAYED EXPERIMENTS

Magnitude-mode one-step 2D RELAY (**cosyqfr1**)
Magnitude-mode one-step 2D RELAY with incremented mixing times (**cosyimqfr1**)
Magnitude-mode two-step 2D RELAY (**cosyqfr2**)
Magnitude-mode two-step 2D RELAY with h incremented mixing times (**cosyimqfr2**)
Magnitude-mode three-step 2D RELAY (**cosyqfr3**)

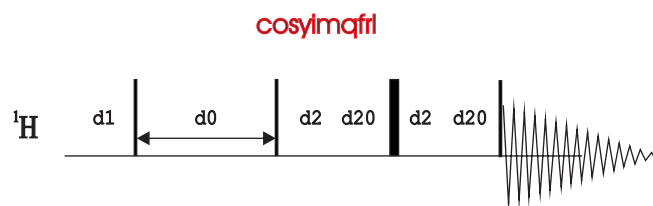
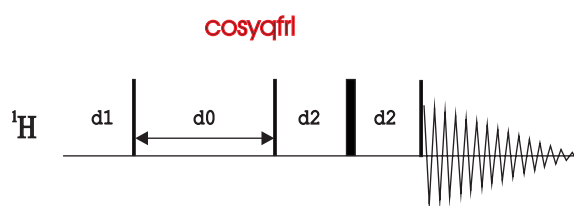
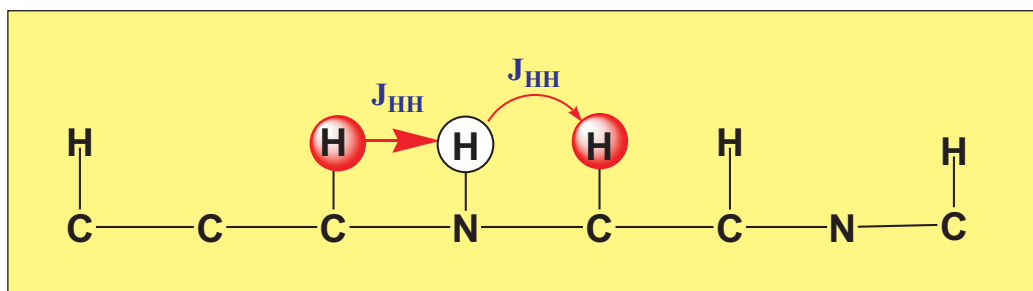

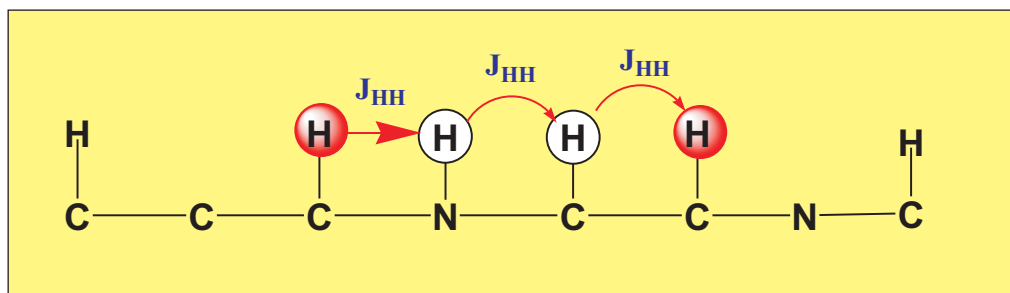

cosyqfr2

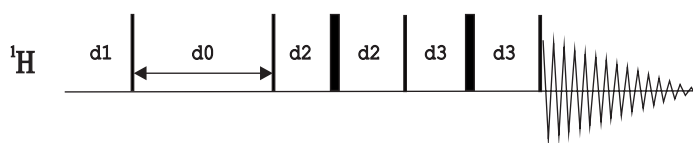

cosylmqfr2

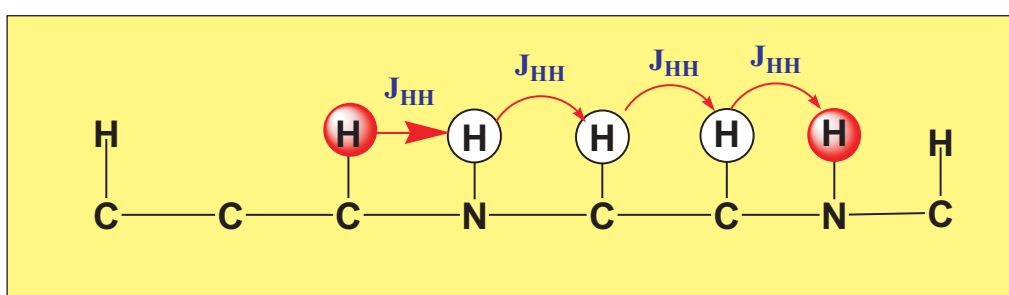

cosyqfr3

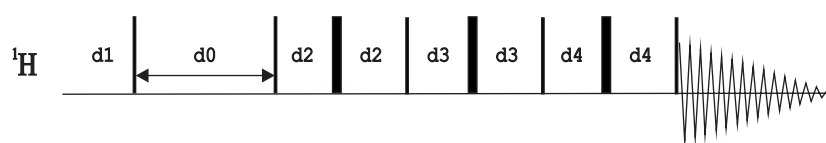

BRUKER PULSE PROGRAM CATALOGUE

NMRGuide

2D TOCSY EXPERIMENTS

Phase-cycled

Phase-sensitive 2D TOCSY using MLEV (**mlevph** | **MLEVPHSW**)
Phase-sensitive 2D TOCSY using MLEV with purge pulses before d1 (**mlevphpp**)
Phase-sensitive 2D TOCSY using DIPSI-2 (**dipsi2ph**)

Phase-cycled and solvent suppression

Phase-sensitive 2D TOCSY with presaturation using MLEV (**mlevphpr** | **MLEVPHPR**)
Phase-sensitive 2D TOCSY with presaturation using MLEV only using first trim pulse (**mlevphpr.2** | **H2OSUPMLEV**)
Phase-sensitive 2D TOCSY with presaturation using DIPSI-2 (**dipsi2phpr**)
Phase-sensitive 2D Clean-TOCSY with presaturation using MLEV (**clmlevphpr**)

Gradient-based

Phase-sensitive ge-2D TOCSY with MLEV using echo-antiecho (**mlevetgp**)
Phase-sensitive ge-2D TOCSY with DIPSI-2 using echo-antiecho (**dipsi2etgp**)
Phase-sensitive ge-2D TOCSY with DIPSI-2 using PEP (**dipsi2etgps**)

Gradient-based and solvent suppression

Phase-sensitive 2D TOCSY with WATERGATE (3-9-19) using MLEV (**mlevgpph19** | **MLEVGPPH19SW**)
Phase-sensitive 2D TOCSY with WATERGATE (3-9-19) using DIPSI-2 (**dipsi2gpph19**)
Phase-sensitive sensitivity-improved 2D TOCSY with WATERGATE (3-9-19) and using DIPSI-2 (**dipsi2etgps19**)
Phase-sensitive 2D Adiabatic TOCSY with WATERGATE (3-9-19) using X_M16 sequence (**atocsygpph19**)

Phase-sensitive 2D TOCSY with excitation sculpting (W5) using MLEV (**mlevgpphw5**)
Phase-sensitive 2D TOCSY with excitation sculpting (180 water-selective pulse-ES element) using MLEV (**mlevesgpph**)
Phase-sensitive 2D TOCSY with excitation sculpting (180 water-selective pulse-ES element) using DIPSI-2 (**dipsi2esgpph**)

Related Experiments:

- LC-NMR Experiments

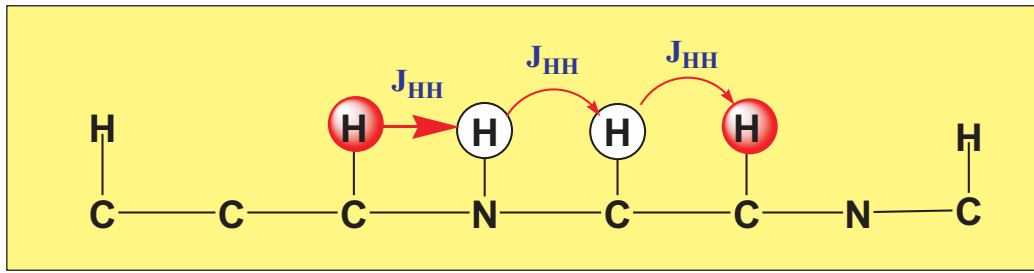

mlevph

mlevphpp

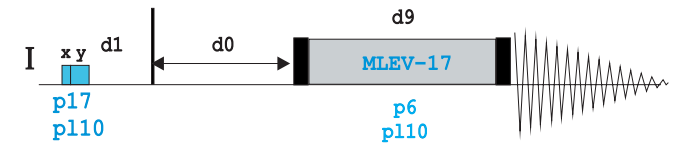
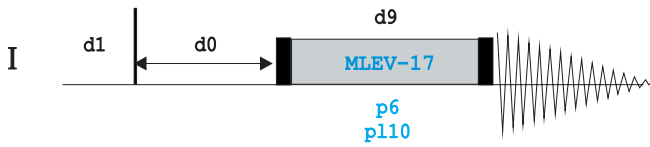

mlevphpr

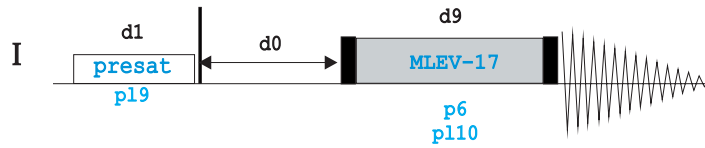

mlevphpr.2

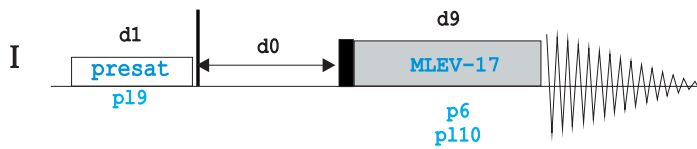

clmlevphpr

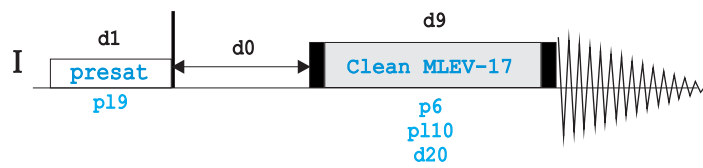

clpsi2ph

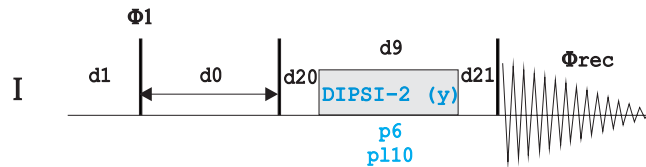

clpsi2phpr

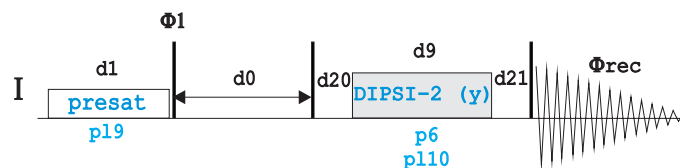

mlevetgp

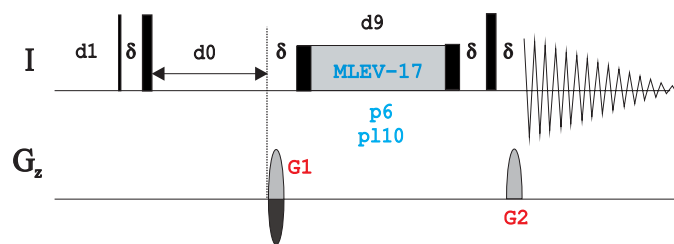

dipsi2etgp

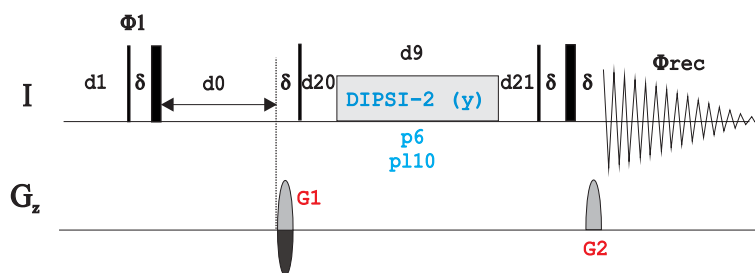

dipsi2etgpsl

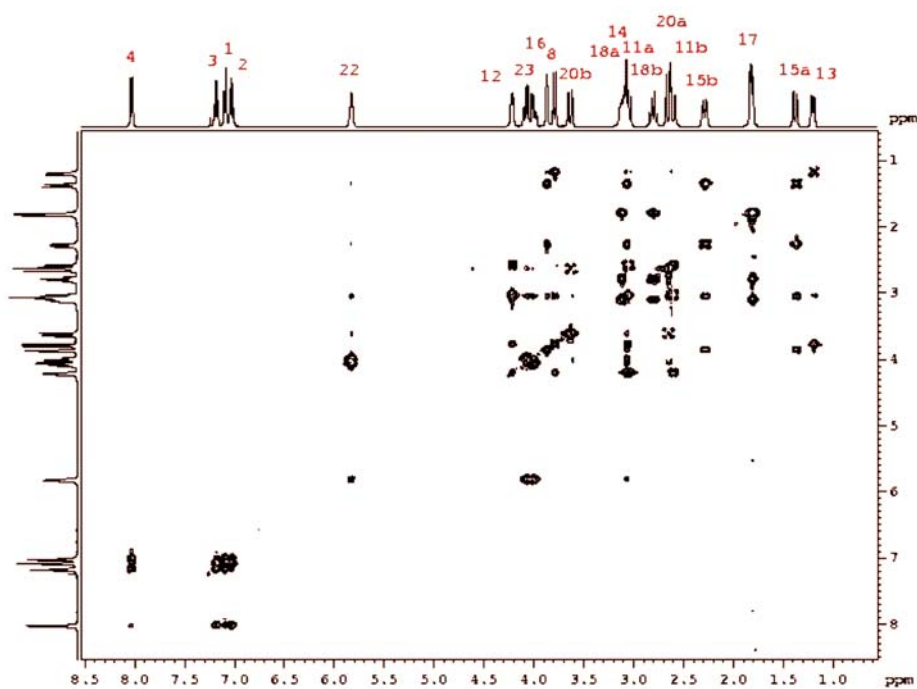
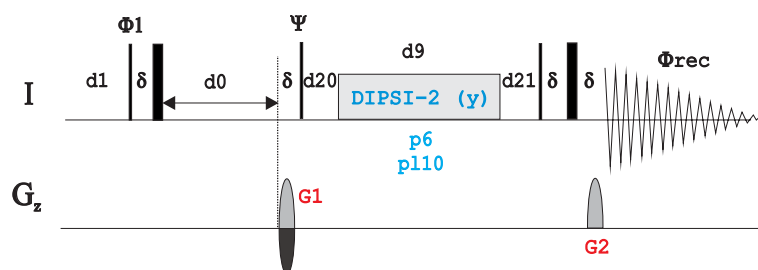

mlevgpqh19

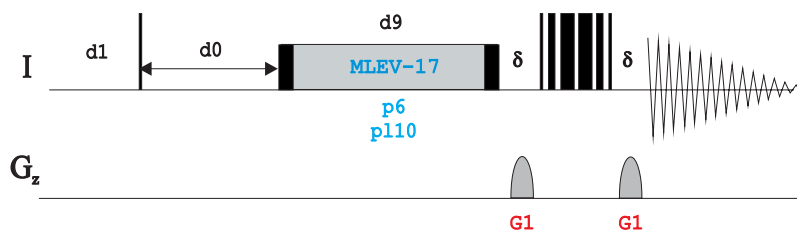

dipsi2gpqh19

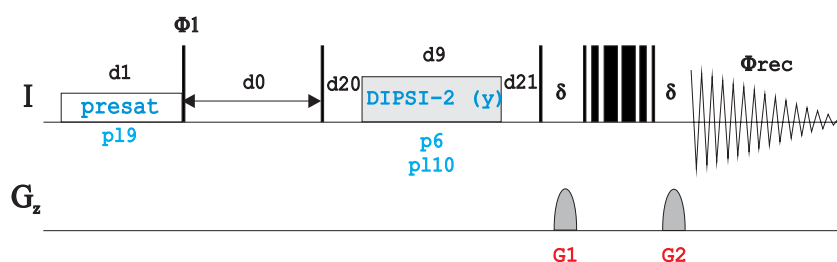

atocsygpqh19

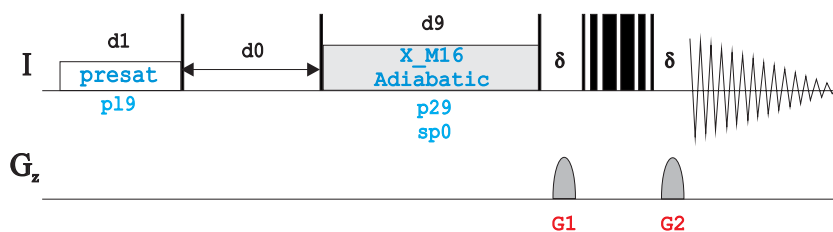

dipsi2etgpsl19

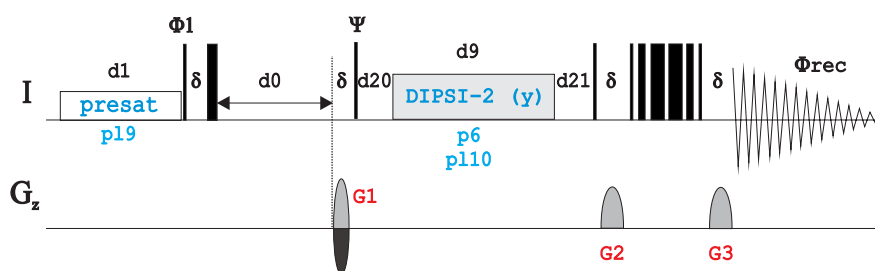

mlevgp-phw5

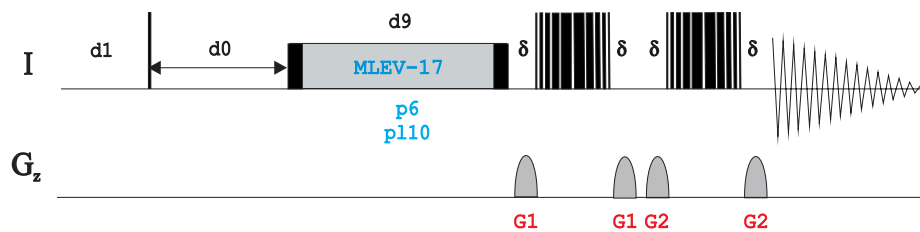

mlevesgpph

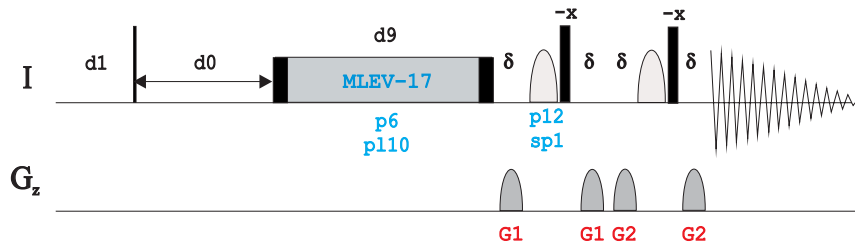

dipsi2esgpph

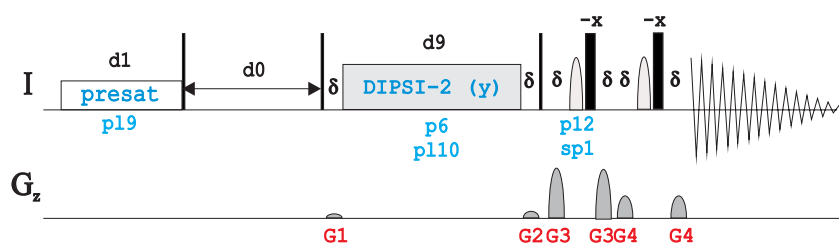

BRUKER PULSE PROGRAM CATALOGUE

NMRGuide

2D ROESY EXPERIMENTS

Phase-cycled:

Phase-sensitive 2D ROESY (**roesyph** | **ROESYPHSW**)
Phase-sensitive 2D ROESY using purgue pulses before d1 (**roesyphpp**)
Phase-sensitive 2D T-ROESY (**roesyph.2**)
Phase-sensitive 2D T-ROESY using purgue pulses before d1 (**roesyphpp.2**)
Phase-sensitive 2D ROESY with compensation (**croesyph**)
Phase-sensitive off-resonance 2D ROESY (**troesyph**)

Phase-cycled and solvent suppression:

Phase-sensitive 2D ROESY with presaturation (**roesyphpr** | **ROESYPHPR**)
Phase-sensitive 2D T-ROESY with presaturation (**roesyphpr.2**)
Phase-sensitive 2D ROESY with compensation and presaturation (**croesyphpr**)
Phase-sensitive off-resonance 2D ROESY with presaturation (**troesyphpr**)

Gradient-based:

Phase-sensitive ge-2D ROESY using echo-antiecho (**roesyetgp**)
Phase-sensitive ge-2D ROESY with T-ROESY using echo-antiecho (**roesyetgp.2**)

Gradient-based and solvent suppression:

Phase-sensitive 2D ROESY with WATERGATE using 3-9-19 (**roesygp19**)
Phase-sensitive 2D T-ROESY with WATERGATE using 3-9-19 (**roesygp19.2**)
Phase-sensitive 2D ROESY with excitation sculpting using 180 water-selective pulse (ES element) (**roesyegpph**)

Related Experiments:

- Selective 1D ROESY Experiments
- 2D NOESY Experiments
- 2D HSQC-ROESY Experiments

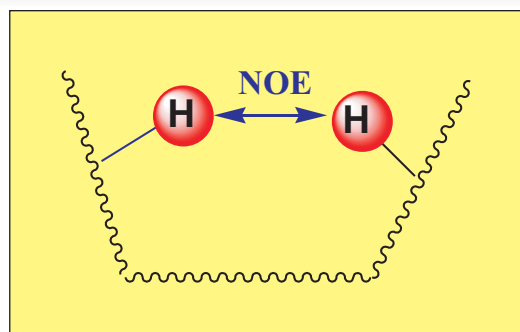

roesyph

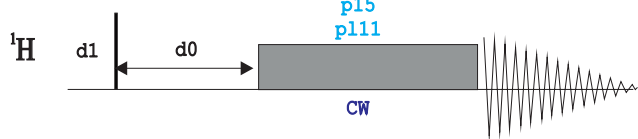

roesyph.2

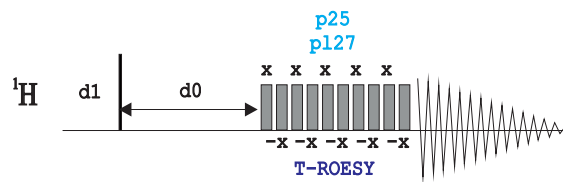

roesyphpp

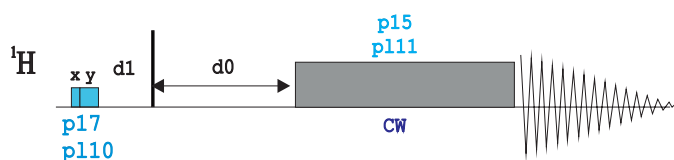

roesyphpp.2

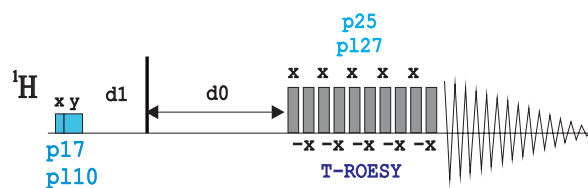

croesyph

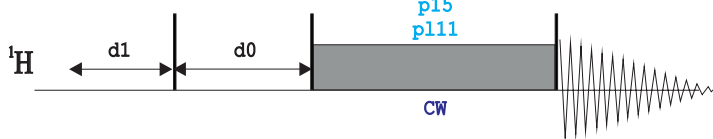

troesyph

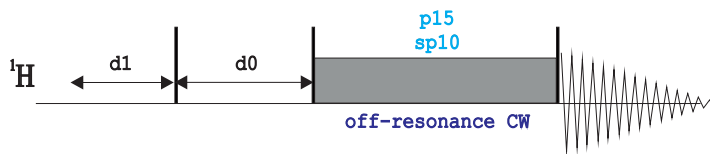

roesyphpr

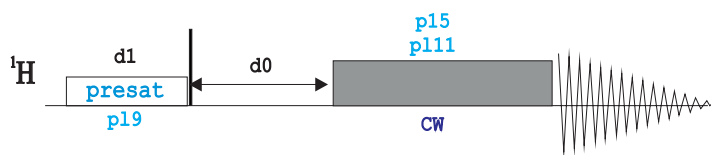

roesyphpr.2

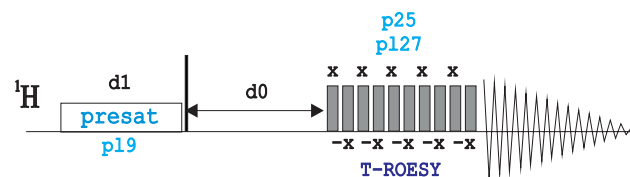

croesyphpr

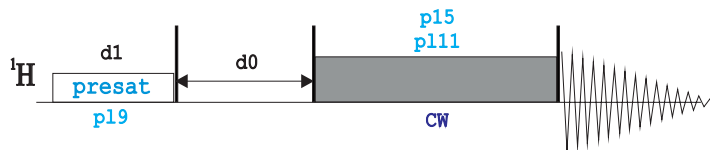

troesyphpr

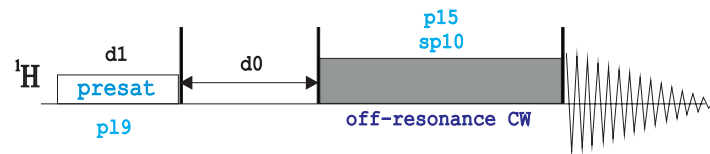

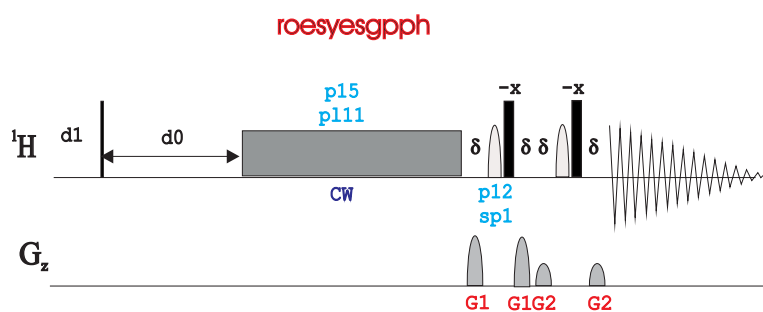
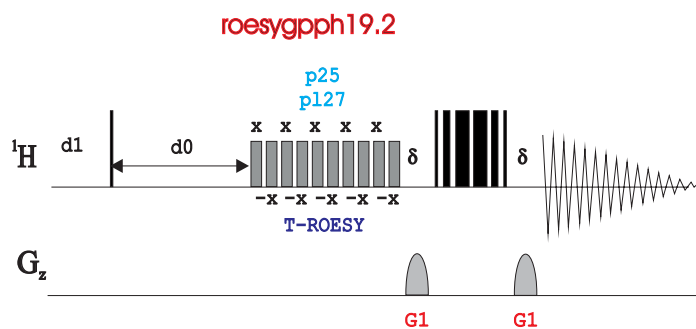
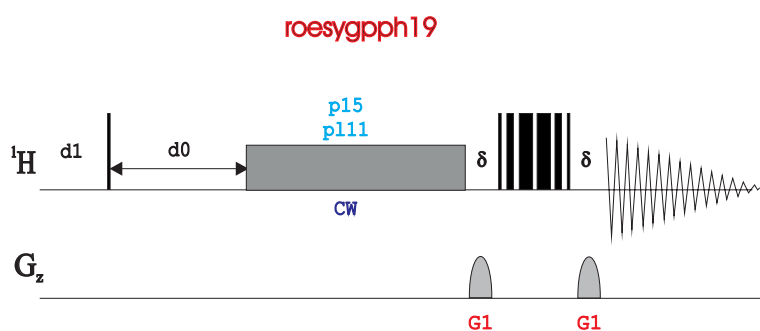
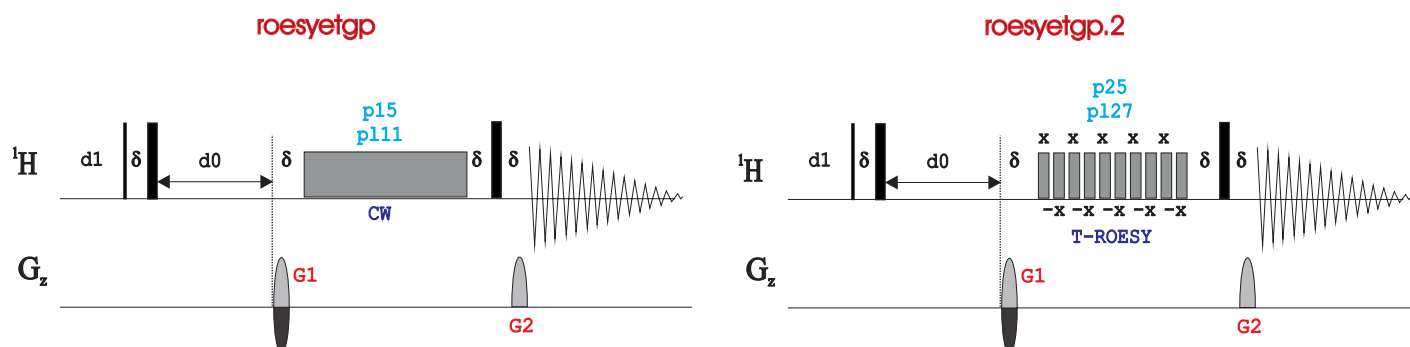

BRUKER PULSE PROGRAM CATALOGUE

NMRGuide

2D NOESY EXPERIMENTS

2D NOESY Experiments

1D Version:

1D NOESY with presaturation (**noesypr1d**)
1D NOESY with presaturation and spoil gradients (**noesygprr1d**)

Phase-cycled:

Phase-sensitive 2D NOESY (**noesyph** | **NOESYPHSW**)
Phase-sensitive 2D NOESY using purge pulses before d1 (**noesyphpp**)
Phase-sensitive 2D NOESY using random mixing time (**noesyphrv**)

Phase-cycled and solvent suppression:

Phase-sensitive 2D NOESY with presaturation (**noesyphpr** | **H2OSUPNOESY**)
Phase-sensitive 2D NOESY with presaturation using random mixing time (**noesyphprrv**)
Phase-sensitive 2D NOESY with 1-1 solvent suppression (**noesyph11**)

Gradient-based:

Phase-sensitive ge-2D NOESY (**noesygp**)
Phase-sensitive ge-2D NOESY using purge pulses before d1 (**noesygp**)
Phase-sensitive ge-2D NOESY with z-spoil (**noesygp**)
Phase-sensitive ge-2D NOESY using echo-antiecho (**noesyetgp**)

Gradient-based and solvent suppression:

Phase-sensitive 2D NOESY using jump-and-return and optional ¹³C and ¹⁵N decoupling during acquisition (**noesygp**)

Phase-sensitive 2D NOESY with WATERGATE:

- Using 3-9-19 (**noesygp** | **NOESYGPPH19SW**)
- Using water flip-back and 3-9-19 (**noesyf**)
- Using water flip-back and water-selective 90 pulses (**noesyf**)
- Using water flip-back, 3-9-19 and PFG in t₁ (**noesyf**)
- Using water flip-back, water-selective 90 pulses and PFG in t₁ (**noesyf**)

Phase-sensitive 2D NOESY with excitation sculpting:

- Using W5 (**noesygp**)
- Using 180 water-selective pulse (ES element) (**noesyeg**)

Related Experiment:

Phase-sensitive 2D NOESY with RELAY and DQF (NOESY-RELAY experiment) (**noesydf**)

Related Experiments:

- Selective 1D NOESY
- 2D ROESY Experiments
- 2D HSQC-NOESY & 2D HMQC-NOESY
- 3D NOESY-HSQC & 3D HSQC-NOESY-HSQC
- 2D & 3D X-filtered NOESY experiments

noesypr1d

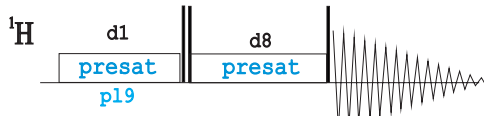

noesygprr1d

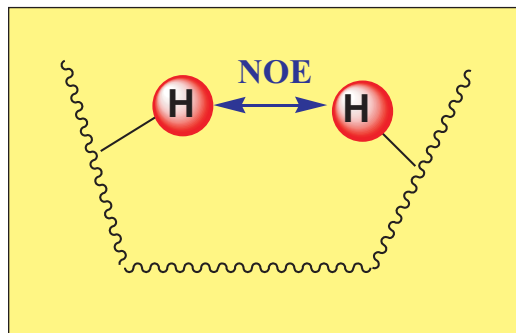
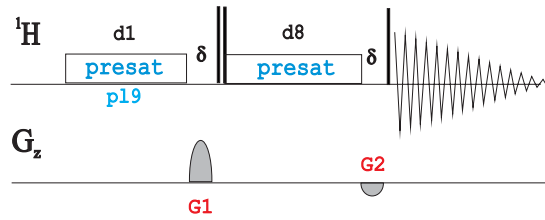

noesyph
 noesyphrv

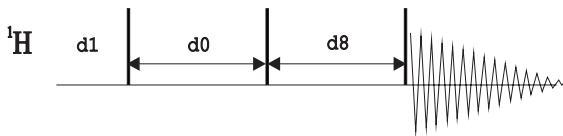

noesyphpp

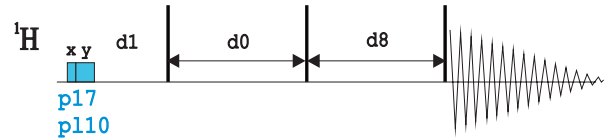

noesyphpr
 noesyphprv

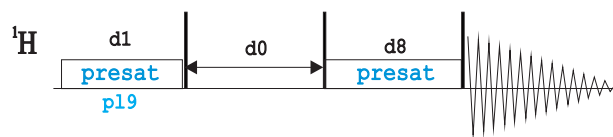

noesyph11

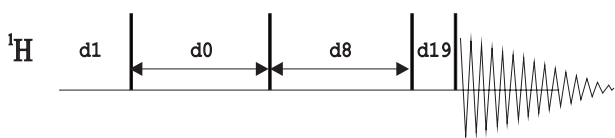

noesydfph1

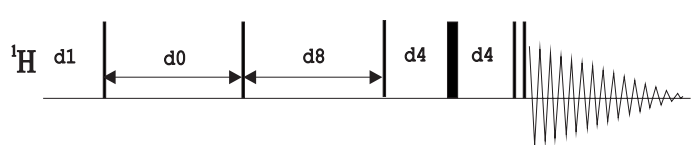

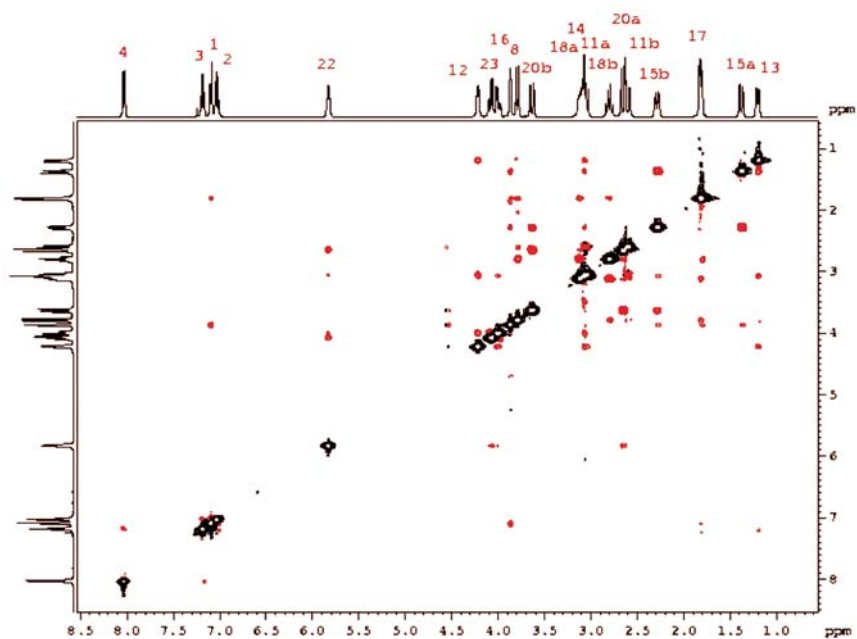

noesygp^{ph}

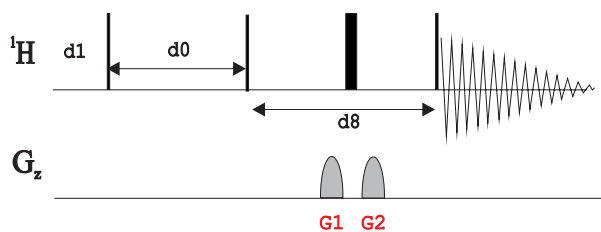

noesygp^{phpp}

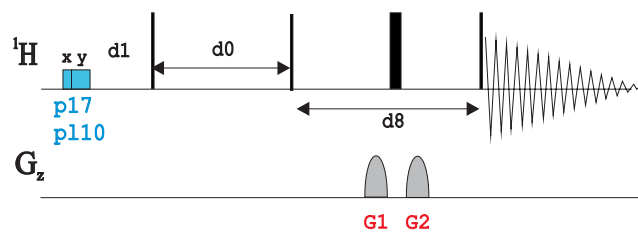

noesyet^{gp}

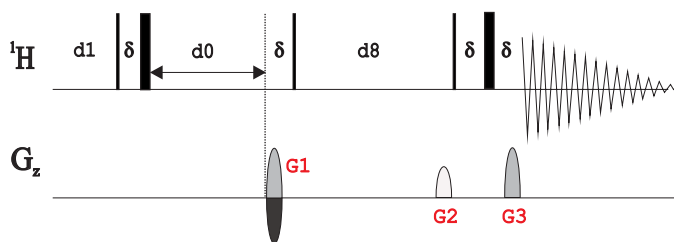

noesygp^{phzs}

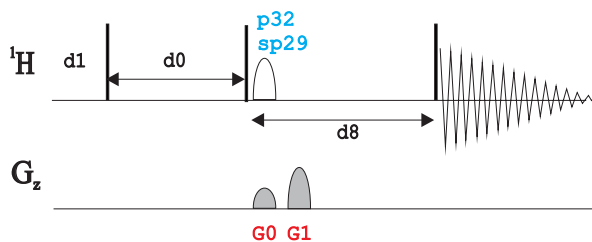

noesygpqh19

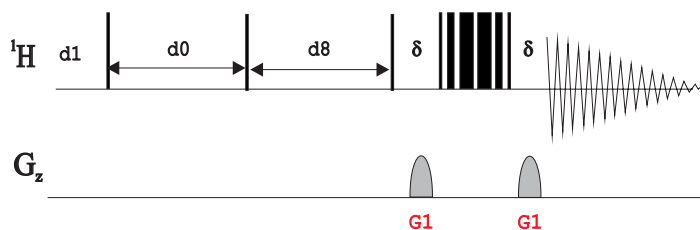

noesyfpgqh19

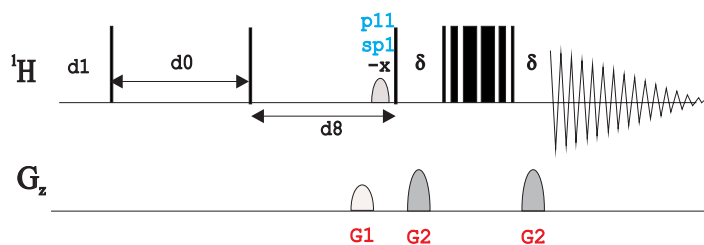

noesyfpgqh19s

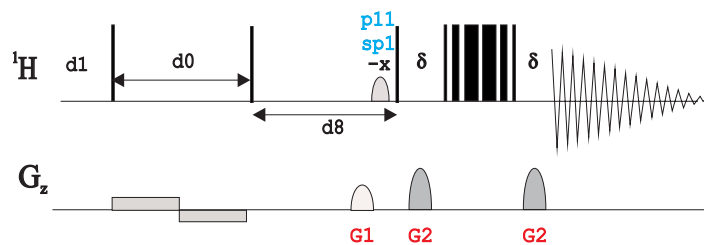

noesyfpgqh19w

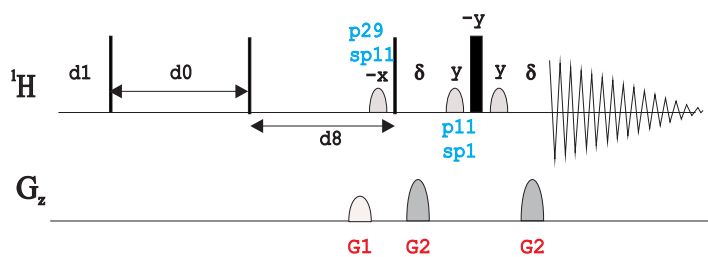

noesyfpgqh19sw

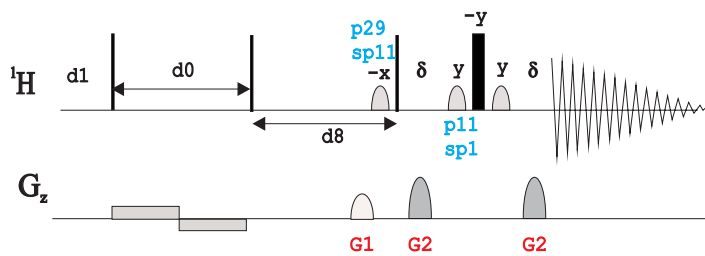

noesyegpph

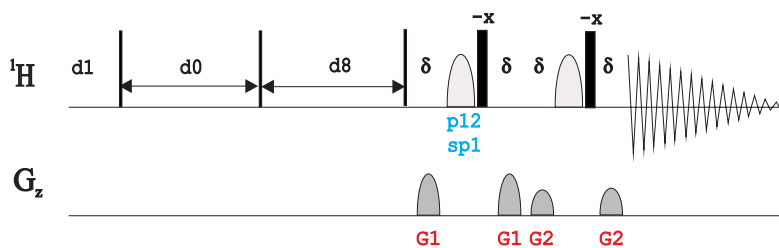

noesygpwh5

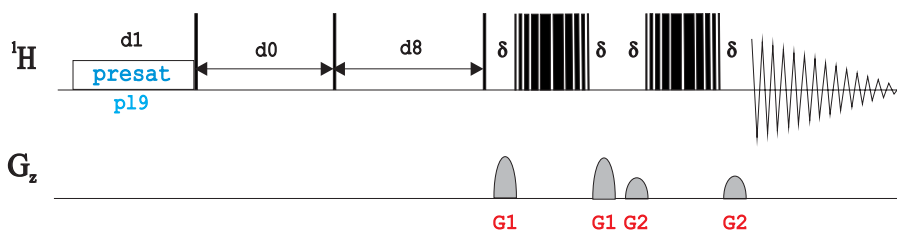

noesygpwhjrs

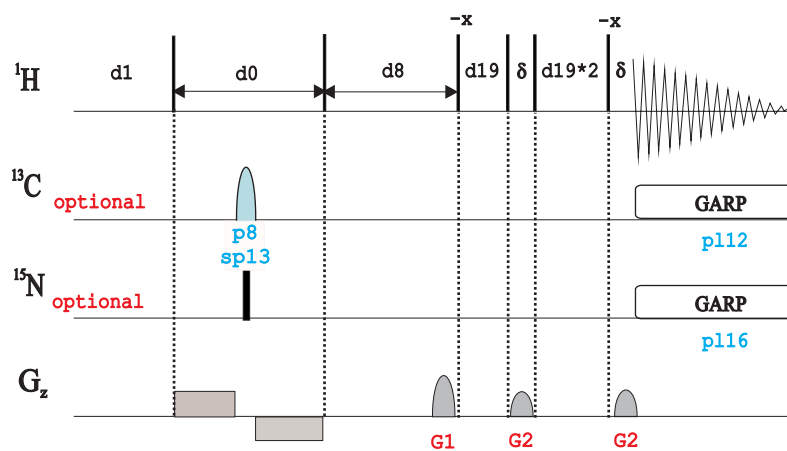

BRUKER PULSE PROGRAM CATALOGUE

NMRGuide

1D & 2D DOUBLE-QUANTUM
EXPERIMENTS

- **1D Double-Quantum (DQ)**

1D Double-Quantum experiments (**dqs1d**)
1D Multiple Quantum Filter (**mqsqp1d** | **mqsqp1d2**)

- **2D Phase-cycled Double-Quantum (DQ)**

Magnitude-mode 2D Double-Quantum (DQ) (**dqsqf**)
Phase-sensitive Double-Quantum (DQ)(**dqsph**)
Phase-sensitive 2D Double-Quantum (DQ) with presaturation (**dqsphpr**)

- **2D Gradient-based Double-Quantum (DQ)**

Phase-sensitive ge-2D Double-quantum using echo-antiecho, 45/135 degree conversion pulse for better sensitivity and remote peak minimisation (**dqseagp135**)
Phase-sensitive ge-2D Double-quantum using echo-antiecho (**dqseagp90**)

Related Experiments:

- 1D & 2D INADEQUATE

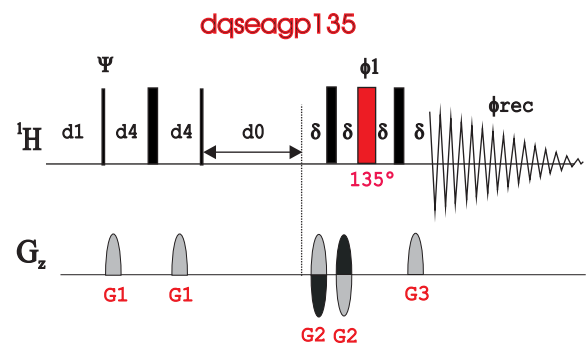
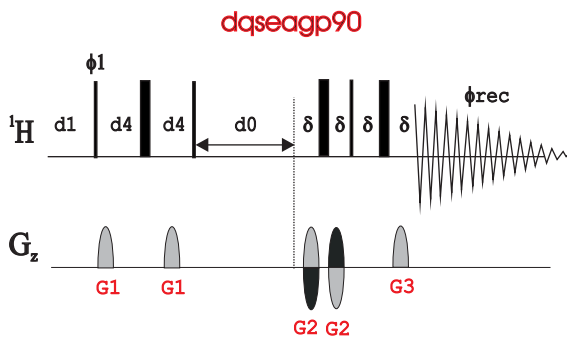
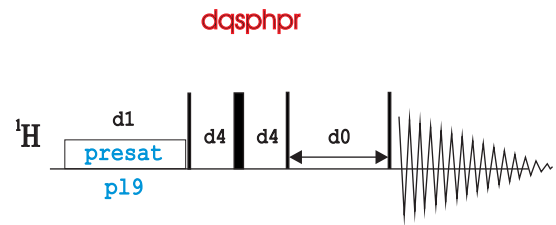
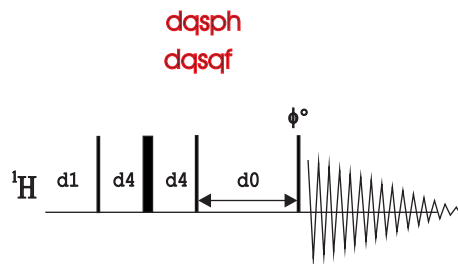
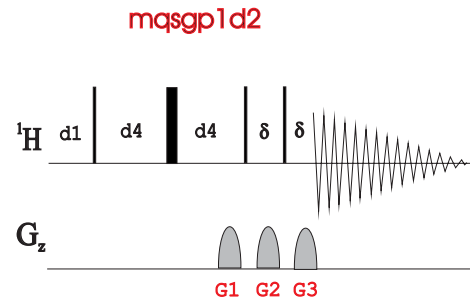
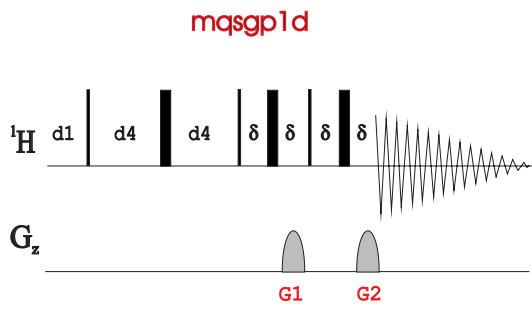
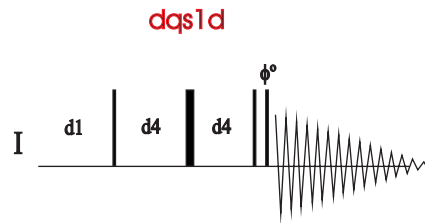

BRUKER PULSE PROGRAM CATALOGUE

NMRGuide

2D J-RESOLVED EXPERIMENTS

- **Classical:**

Magnitude-mode 2D J-Resolved (**jresqf**)
 Magnitude-mode 2D J-Resolved with f2 decoupling (**jresdcqf**)

- **With solvent suppression:**

2D J-Resolved with presaturation (**lcjresprqf**)
 2D J-Resolved with presaturation using shape pulse (**lcjrespsqf**)

Also see:

LC-NMR Experiments

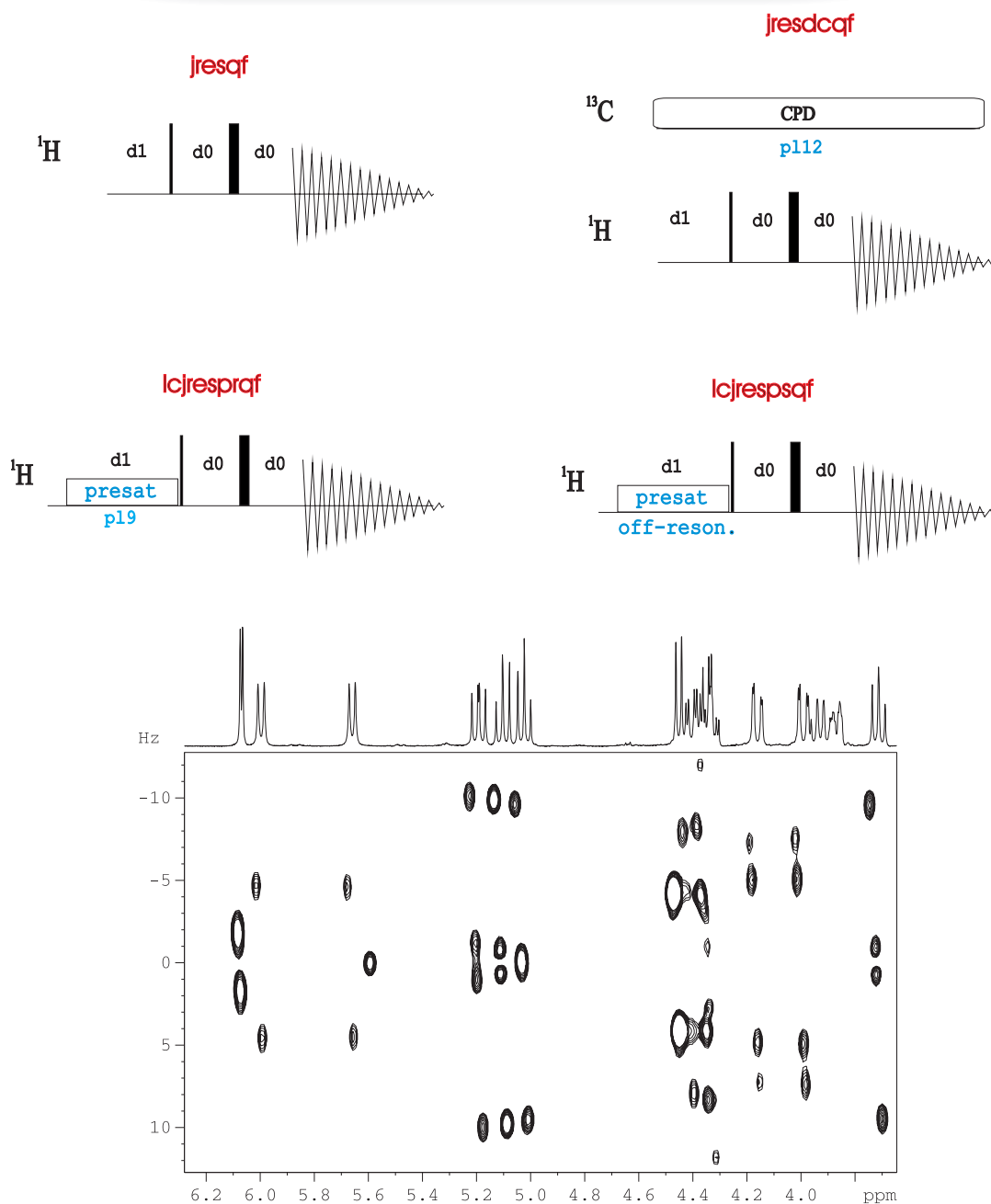

BRUKER PULSE PROGRAM CATALOGUE

NMRGuide

DECOUPLER PULSE CALIBRATION

Calibration of the 90 decoupler pulse (**decp90**, **decp90f3**)
 Calibration of the 90 decoupler shaped pulse (**decp90sp**)

Calibration of the 180 decoupler pulse (**dec180**)
 Calibration of the shaped 180 decoupler pulse (**dec180sp**)
 Calibration of the 180 decoupler pulse using presaturation (**dec180pr**, **dec180f3pr**)

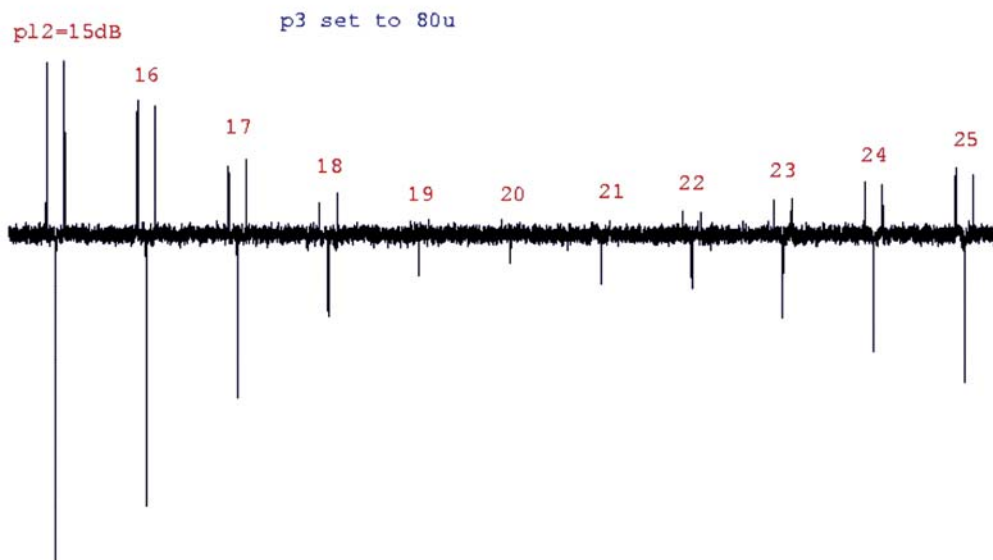
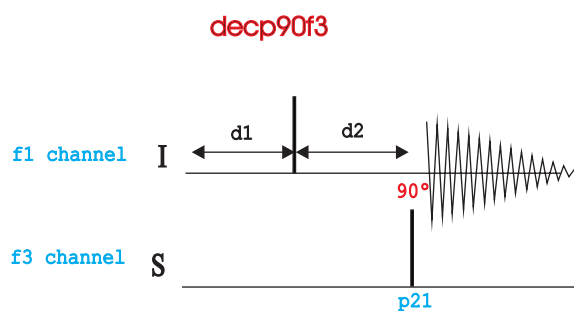
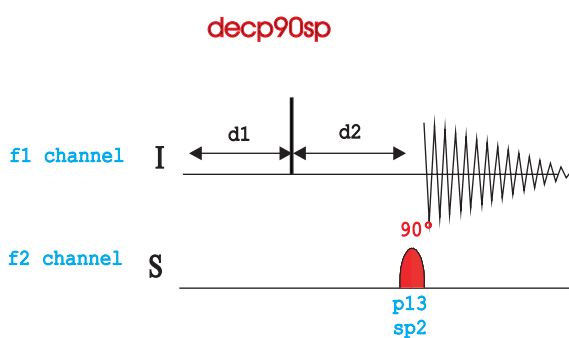
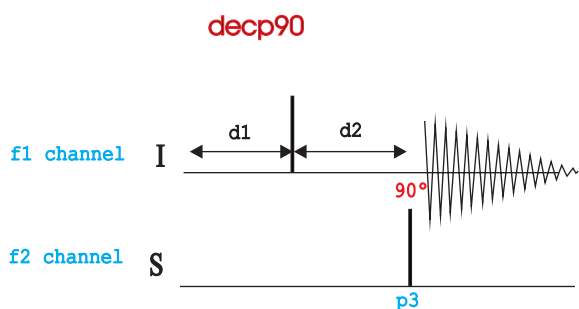

dec180

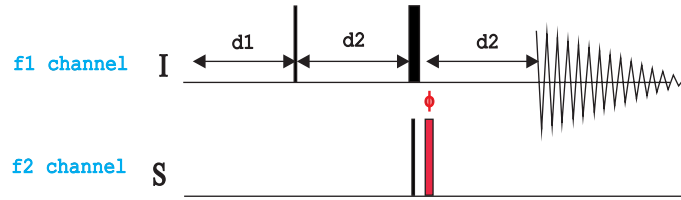

dec180sp

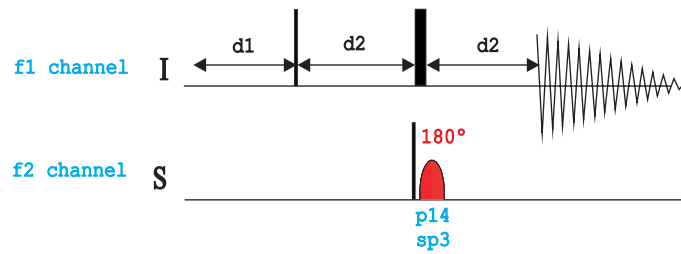

dec180pr

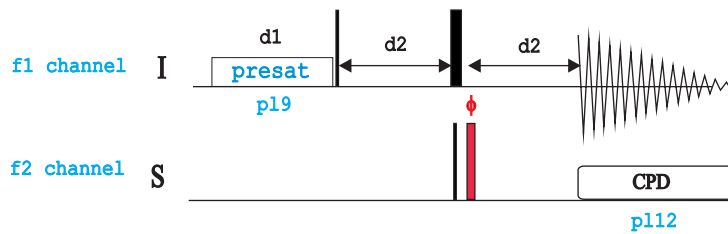

dec180f3pr

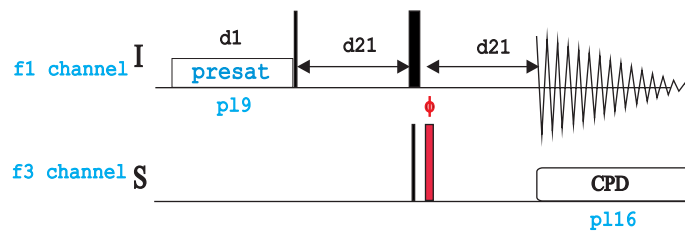

BRUKER PULSE PROGRAM CATALOGUE

NMRGuide

1D DEPT & INEPT EXPERIMENTS

- **DEPT Experiments:**

DEPT (**dept**)
DEPT-45 (**dept45** | C13DEPT45)
DEPT-90 (**dept90** | C13DEPT90)
DEPT-135 (**dept135** | C13DEPT135)
DEPT-45 with adiabatic pulses (**deptsp45** / **deptsp**)
DEPT-90 with adiabatic pulses (**deptsp90**)
DEPT-135 with adiabatic pulses (**deptsp135**)
DEPT with composite pulses (**deptcp**)
DEPT-45 with composite pulses (**deptcp45**)
DEPT-90 with composite pulses (**deptcp90**)
DEPT-135 with composite pulses (**deptcp135**)

DEPT without ¹H-decoupling (**deptnd**)
DEPT++ without ¹H-decoupling (**deptppnd**)

- **INEPT Experiments:**

INEPT without refocusing (**ineptnd**)
Refocused INEPT with decoupling (**ineptrd**)
Refocused INEPT with decoupling using adiabatic pulses (**ineptrdsp**)
INEPT+ without decoupling (**ineptpnd**)

Non-refocused ¹H-coupled ¹⁵N spectrum using INEPT (**ineptnd**)
¹H-decoupled ¹⁵N spectrum using INEPT (**ineptrd** | N15INEPT)
Refocused ¹H-coupled ¹⁵N spectrum using INEPT+ (**ineptpnd**)

1D X-relayed H,X-COSY (**ineptrl1** / **ineptrl2**)

- **Other editing experiments:**

Spin-Echo or SEFT (**jmod**)
Conventional APT (**apt** | C13APT)
APT with J-compensation (**aptjc**)

Quaternary-carbons with decoupling (**quatd**)
Quaternary-carbons without decoupling (**quat**)

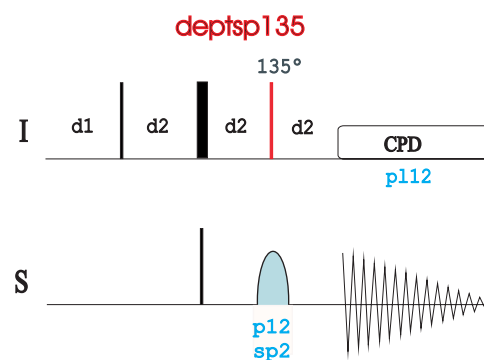
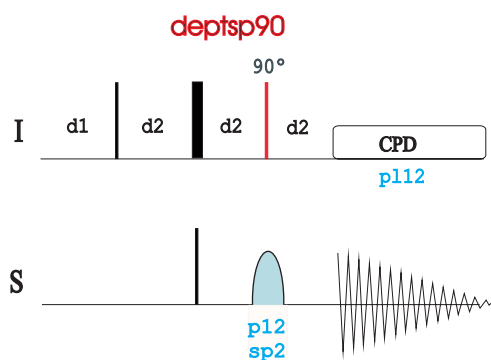
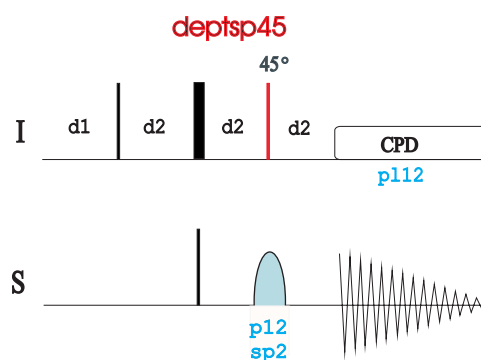
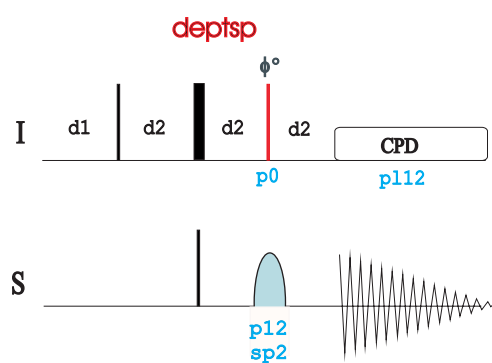
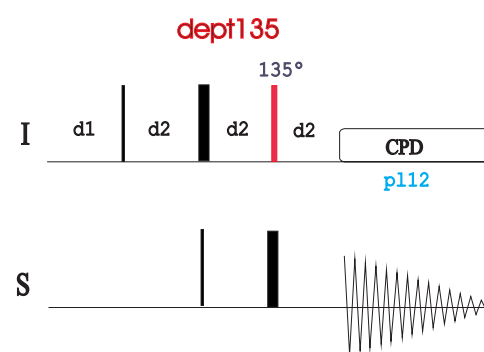
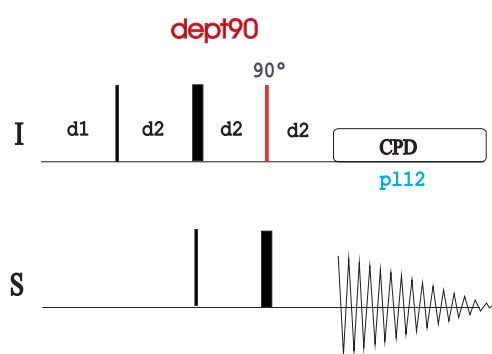
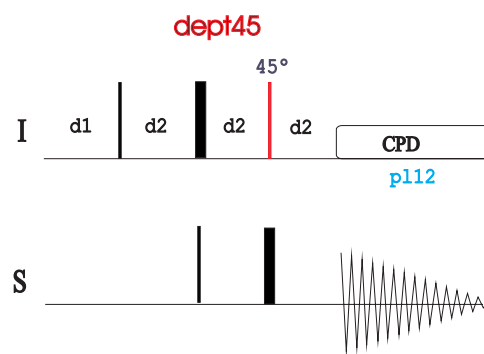
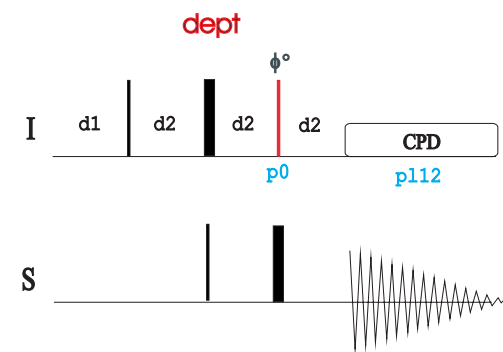

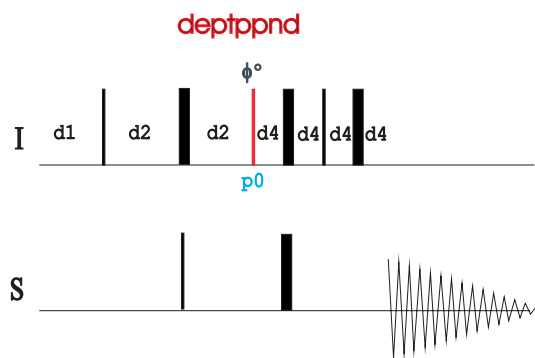
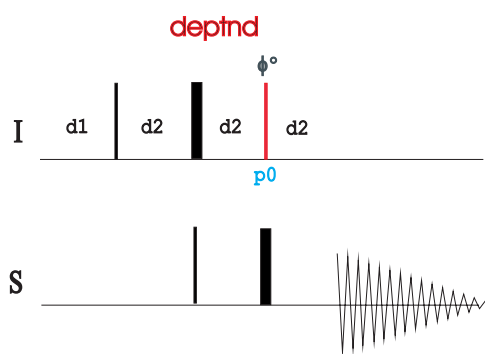
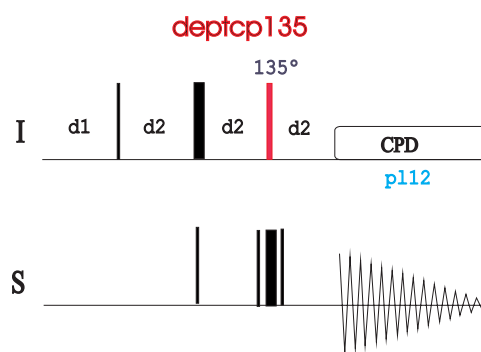
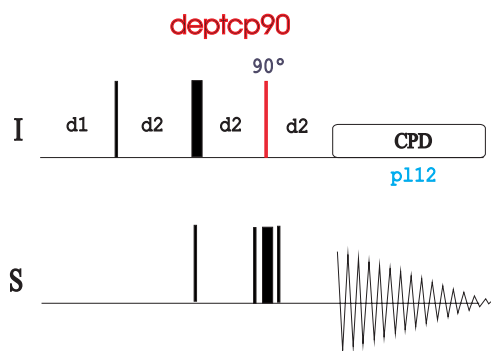
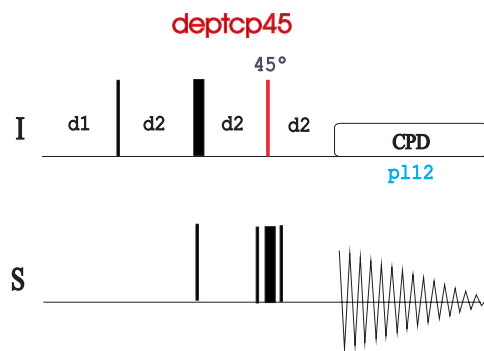
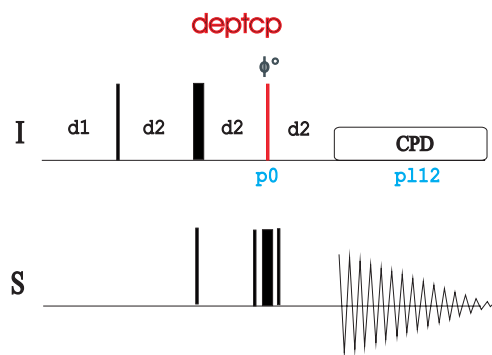

ineptnd

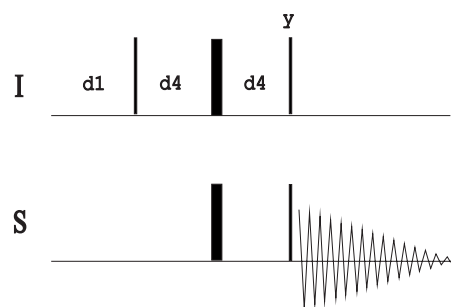

ineptrd

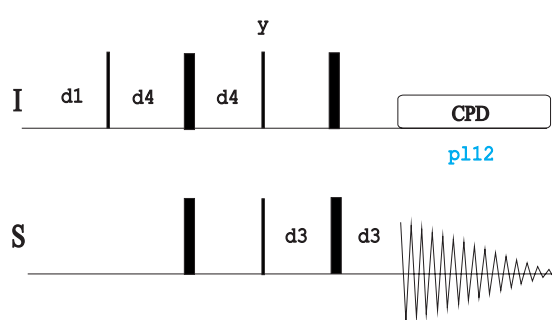

ineptrdsp

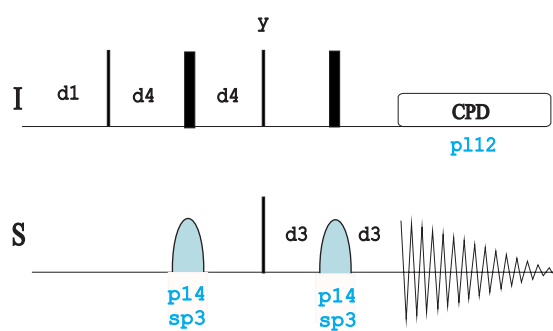

ineptpd

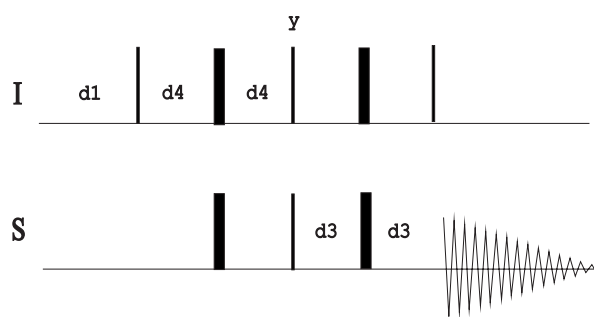

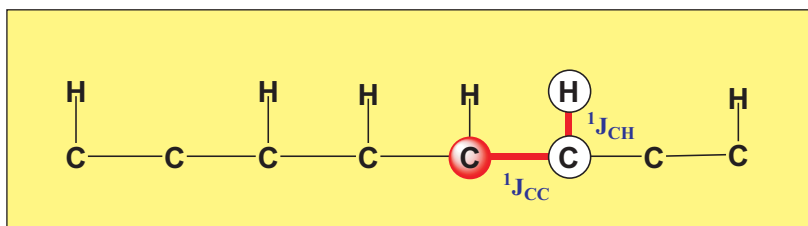

inept1

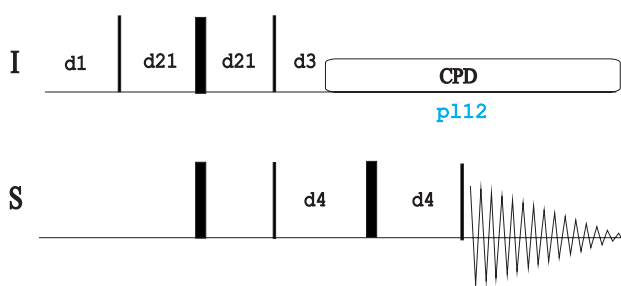

Also see ineptin

inept12

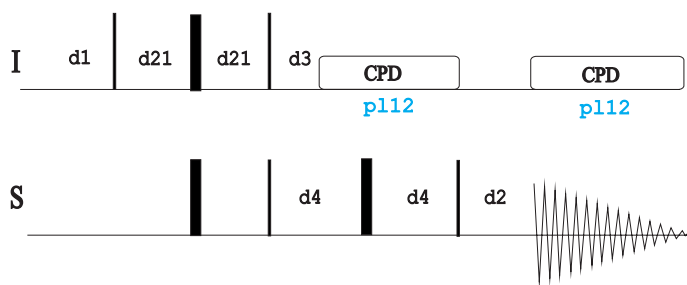

jmod

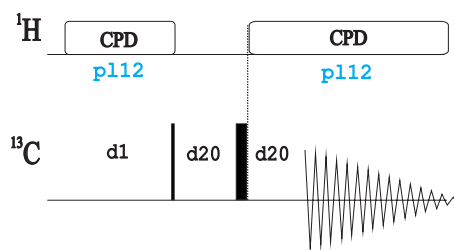

apt

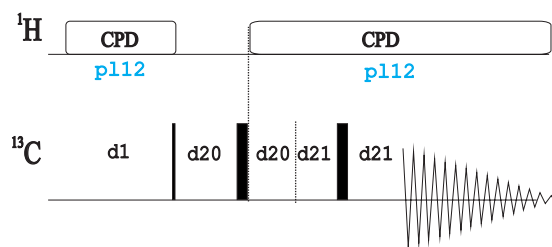

aptjc

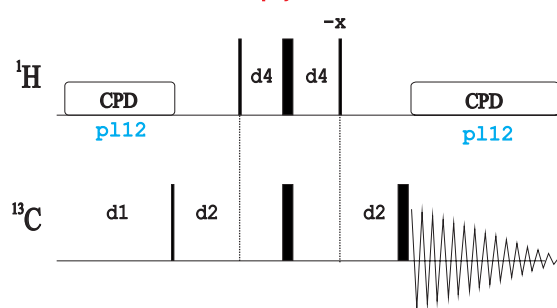

quat

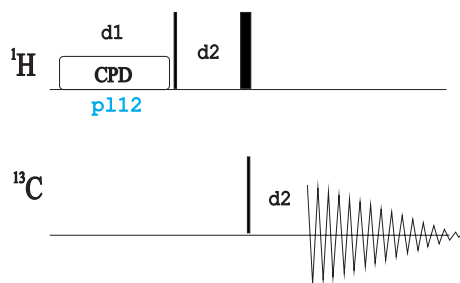

quatd

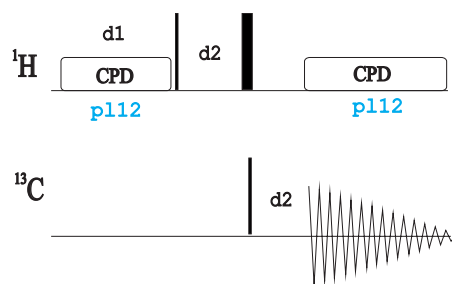

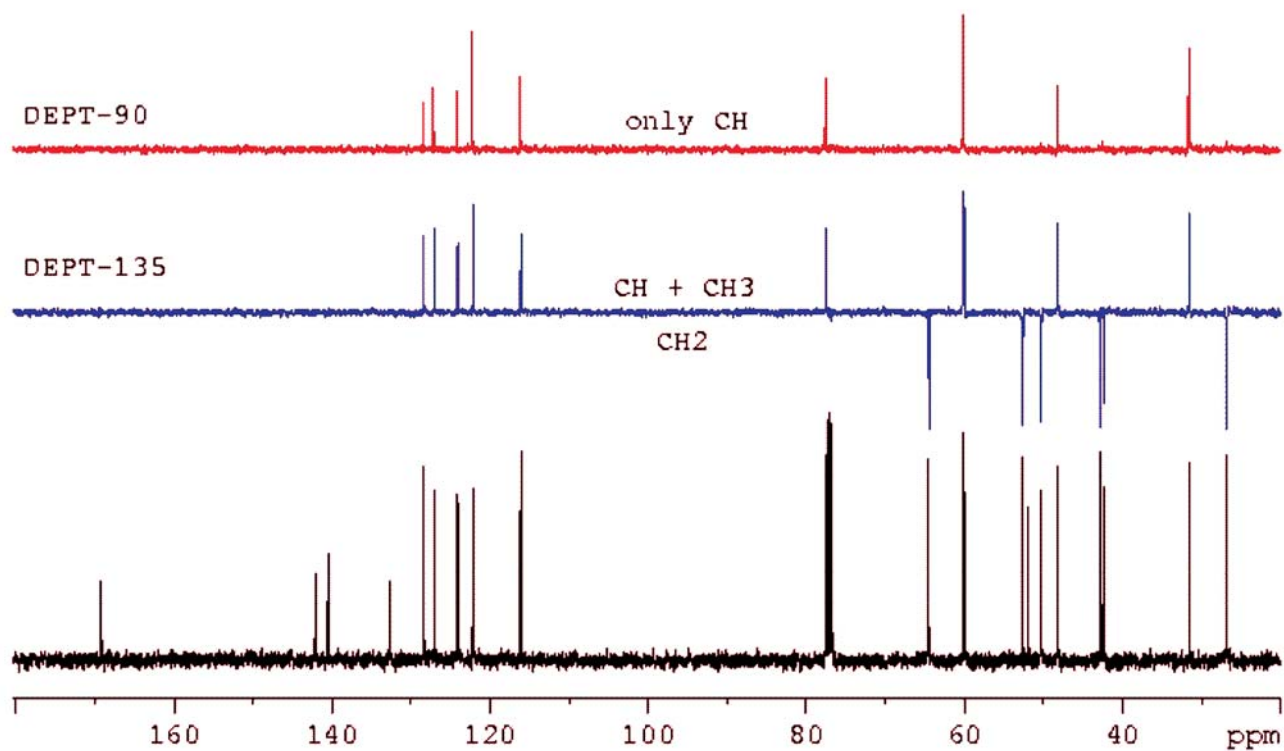

BRUKER PULSE PROGRAM CATALOGUE

NMRGuide

2D X-DETECTED HETCOR
EXPERIMENTS

- **INEPT-Based HETCOR**

- Magnitude-mode 2D HETCOR (**hxcoqf** | **hccosw**)
- Magnitude-mode 2D HETCOR with 2H-decoupling (**hxcoqf2h**)
- Magnitude-mode 2D HETCOR using composite pulses (**hxcocpqf**)
- Magnitude-mode 2D HETCOR with ^1H - ^1H decoupling in F1 using BIRD (**hxcobiqf**)
- Magnitude-mode 2D HETCOR with ^1H - ^1H decoupling in F1 using BIRD and composite pulses (**hxcobicpqf**)
- Magnitude-mode 2D HETCOR with refocusing of chemical shifts (**hxinepqf**)
- Phase-sensitive 2D HETCOR with refocusing of chemical shifts (**hxinepph**)

- **DEPT-based HETCOR**

- Magnitude-mode DEPT-based 2D HETCOR (**hxdeptqf**)
- Phase-sensitive DEPT-based 2D HETCOR (**hxdeptph**)
- Magnitude-mode DEPT-based 2D HETCOR with ^1H - ^1H decoupling in F1 using BIRD (**hxdeptbiqf**)
- Phase-sensitive DEPT-based 2D HETCOR with ^1H - ^1H decoupling in F1 using BIRD (**hxdeptbiph**)

- Phase-sensitive DEPT-based TOCSY-HETCOR experiment (**hxdeptmlph**)

- **2D H-relayed HETCOR experiment**

- Magnitude-mode 2D H-relayed HETCOR (**hhxcoqf** / **hhxcoqf.2**)

- **2D X-relayed HETCOR experiment**

- Magnitude-mode 2D X-relayed HETCOR (**hxxcoqf**)

Related Experiments:

- 2D HMQC
- 2D HSQC

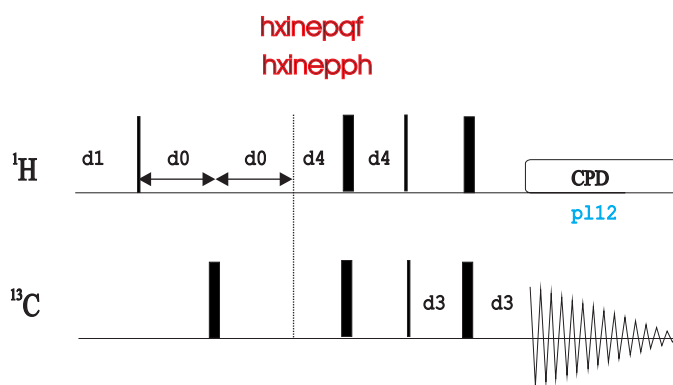
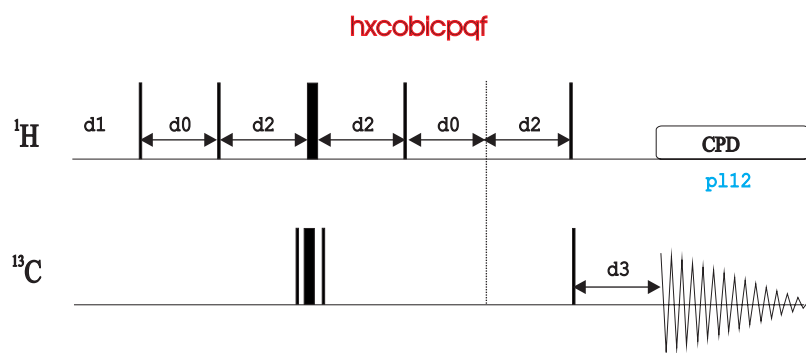
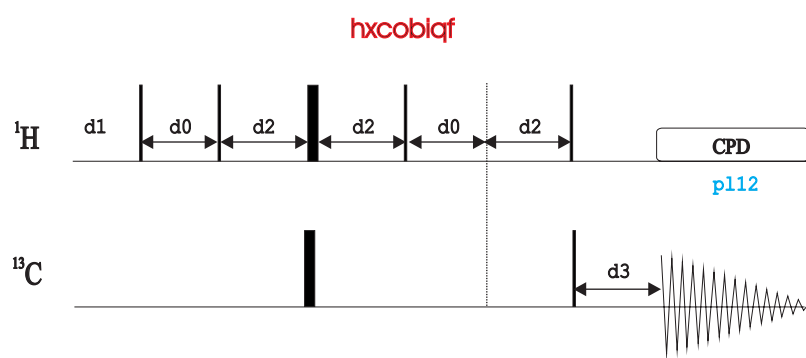
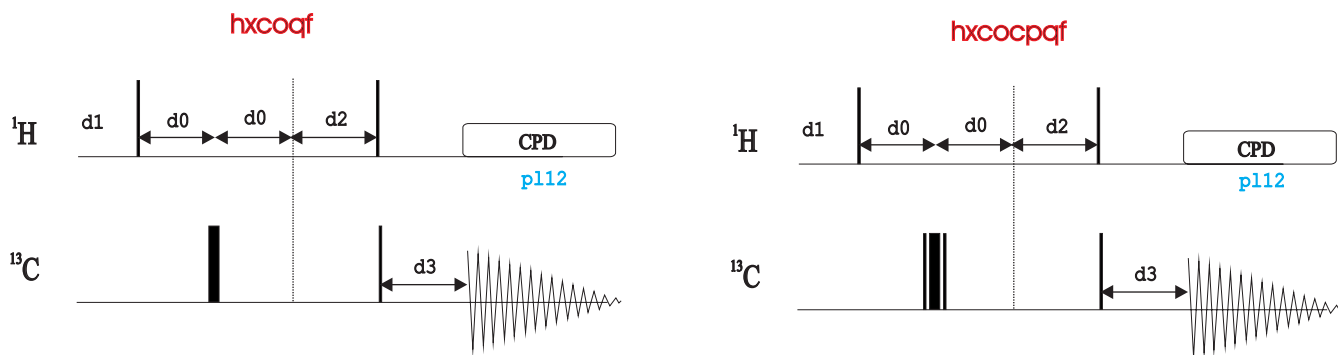
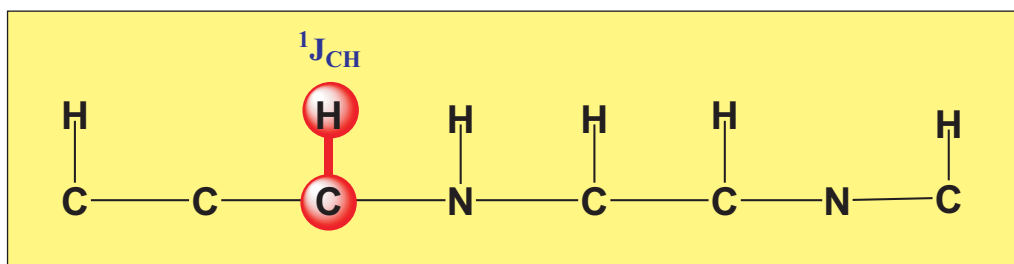

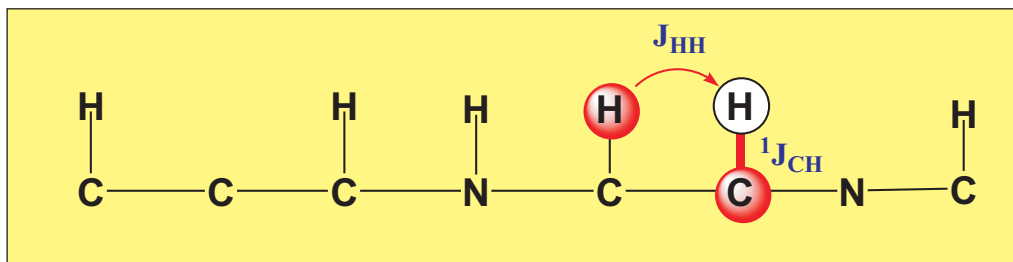

hxxcoqf

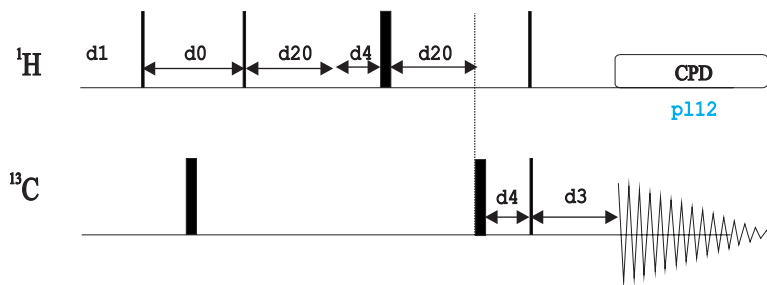

hxxcoqf.2

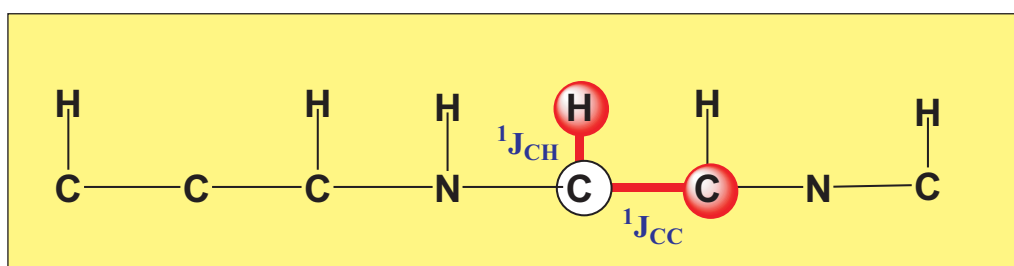
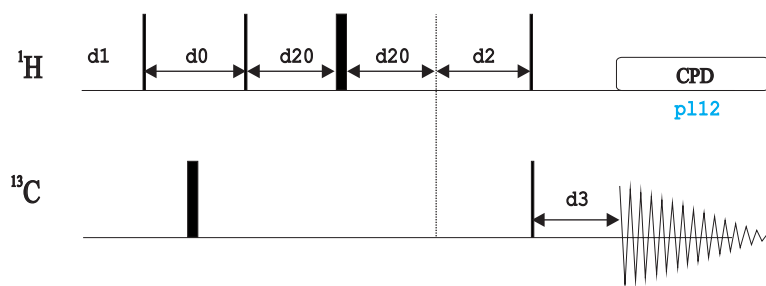

hxxcoqf

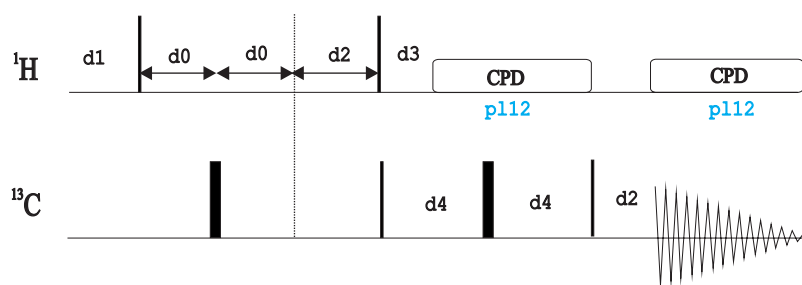

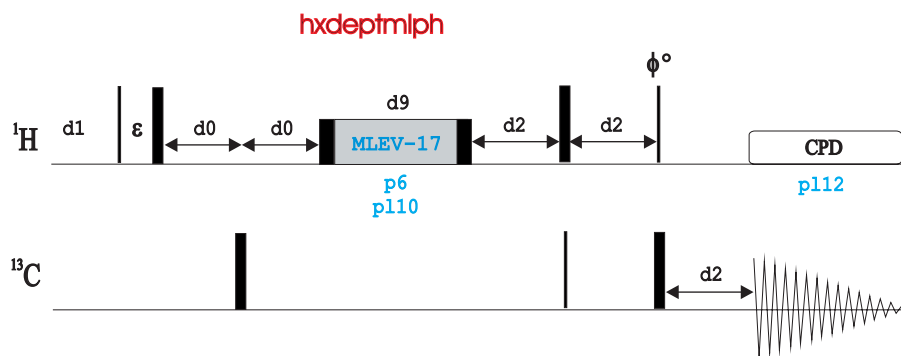
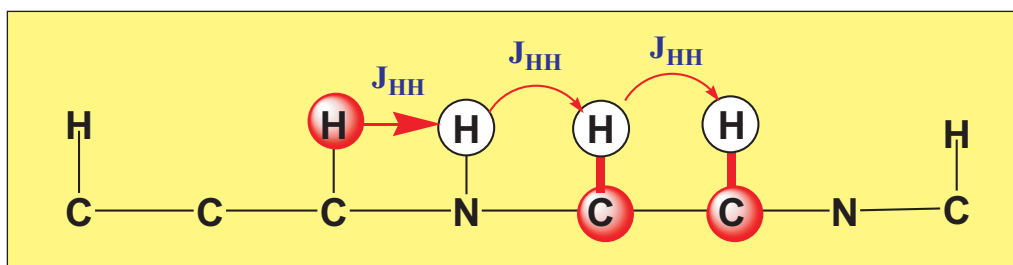
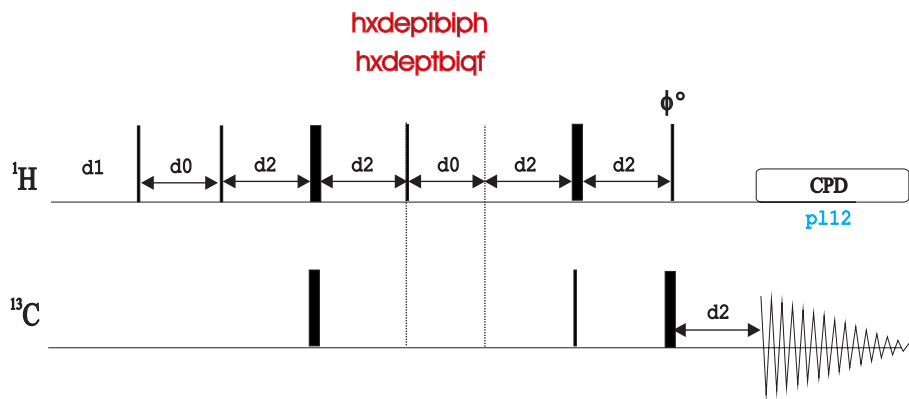
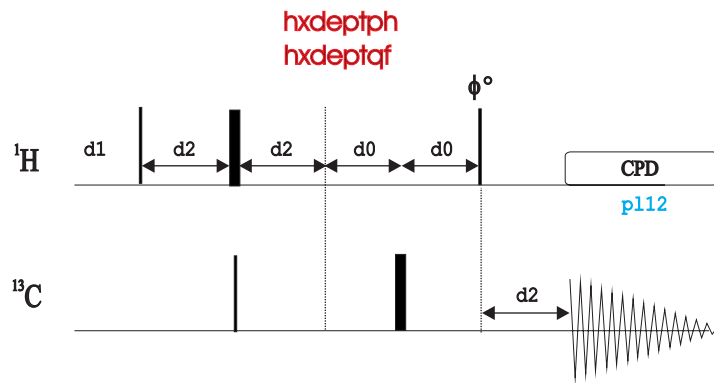
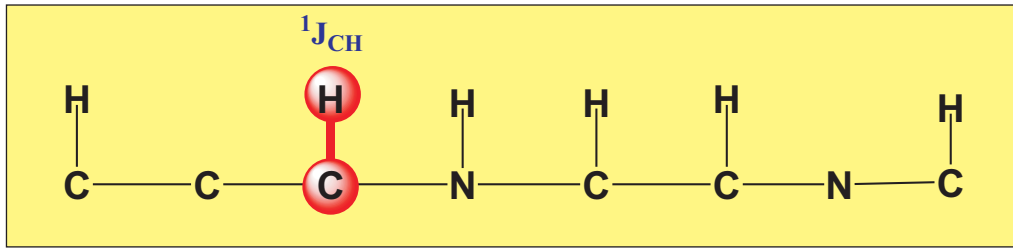

BRUKER PULSE PROGRAM CATALOGUE

NMRGuide

2D COLOC EXPERIMENT

- Magnitude-mode 2D COLOC (**colocqf** | HCCOLOCsw)

Related Experiments:

- 2D HETCOR
- 2D HMBC

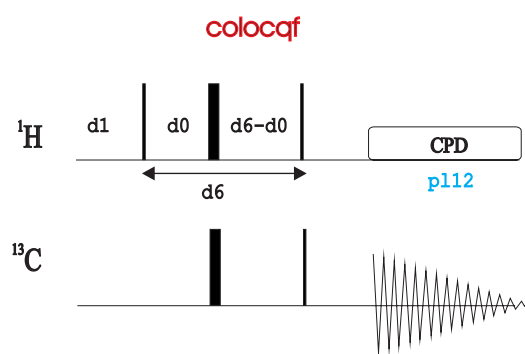
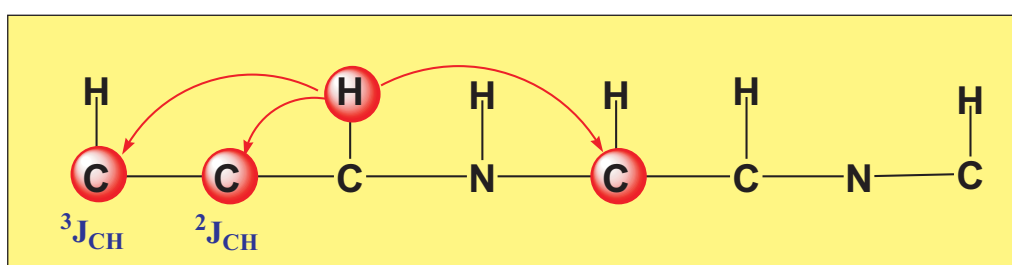

BRUKER PULSE PROGRAM CATALOGUE

NMRGuide

2D HETERONUCLEAR
J-RESOLVED EXPERIMENT

Magnitude-mode 2D Heteronuclear J-Resolved (**hjresqf**)

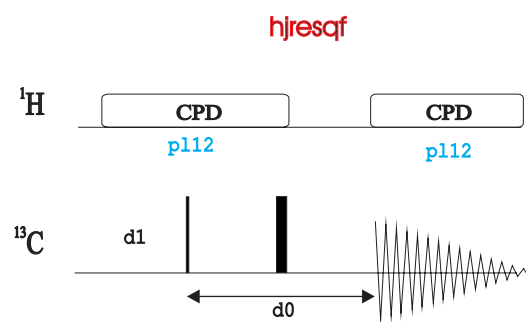

BRUKER PULSE PROGRAM CATALOGUE

NMRGuide

2D HOESY EXPERIMENTS

Magnitude-mode 2D ^1H - ^{13}C HOESY (**hoesyqfrv**)
Phase-sensitive 2D ^1H -X HOESY (**hoesyph**)

Also see ^{19}F experiments
(**hoesyfhqfrv**)

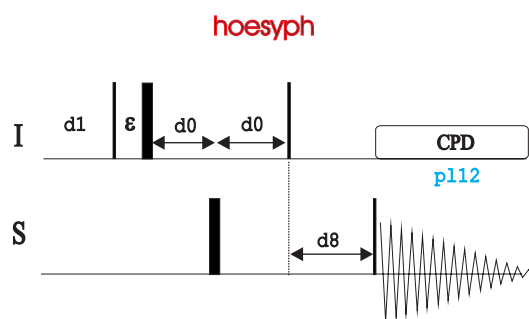
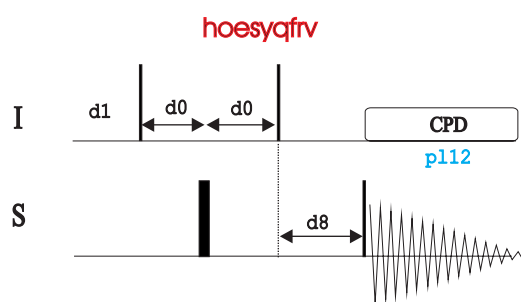
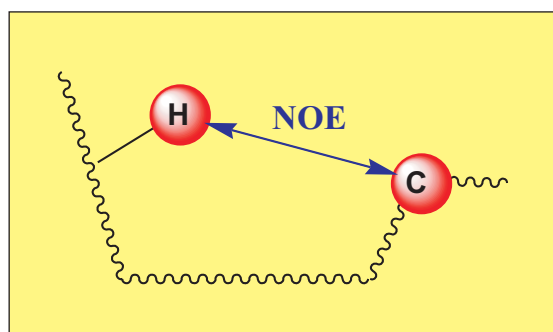

BRUKER PULSE PROGRAM CATALOGUE

NMRGuide

1D & 2D INADEQUATE
EXPERIMENTS

- **1D INADEQUATE**

1D INADEQUATE without refocusing (**inad1d**)
1D INADEQUATE using composite pulses (**inadcp1d**)
1D INADEQUATE with refocusing (**inadr1d**)
1D INADEQUATE using initial INEPT (**inepin**)

- **2D INADEQUATE**

Magnitude-mode 2D INADEQUATE (**inadqf/ inadqf.2 | INAD**)
Phase sensitive 2D INADEQUATE(**inadph**)
Magnitude-mode symmetric 2D INADEQUATE(**inadqfsy**)

Also see 1D & 2D DQ Experiments

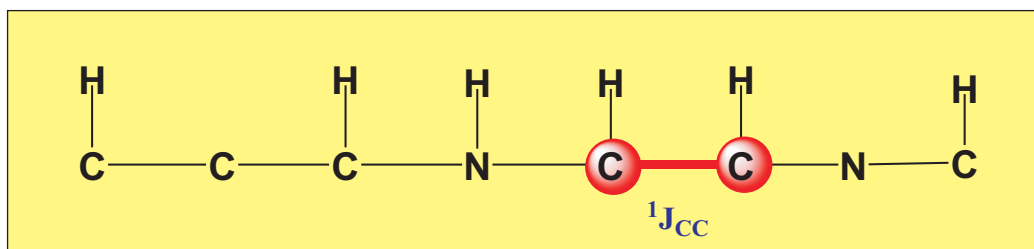

inad1d

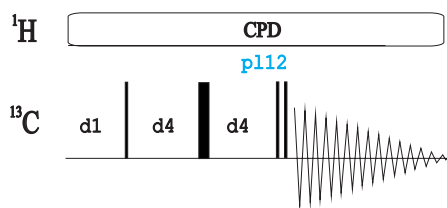

inadrd1d

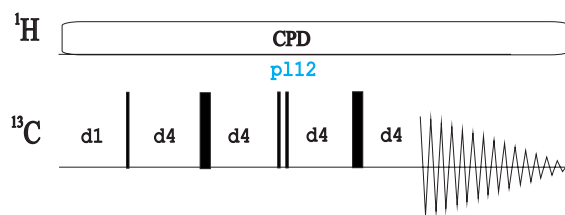

inadcp1d

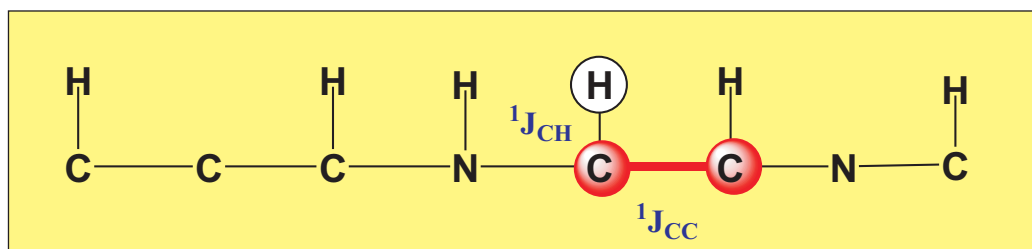
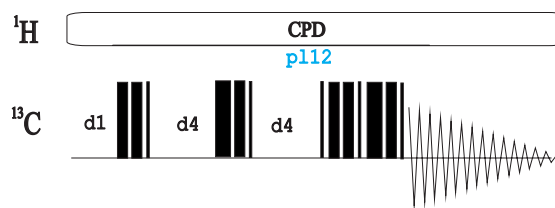

inepin

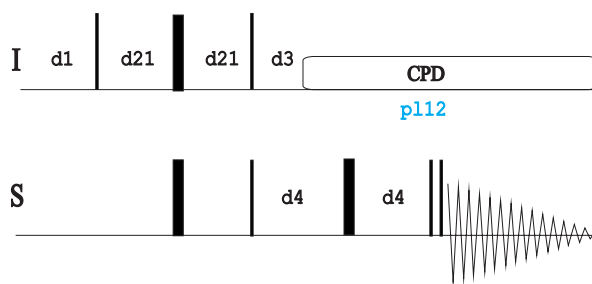

Also see **ineptr11**

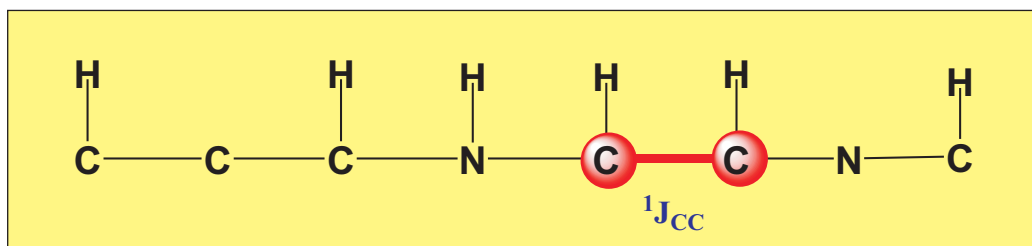

inadqf.2
inadph
inadqf

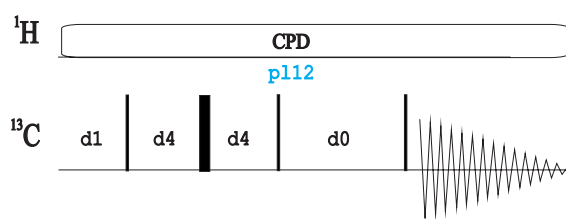

inadqfsy

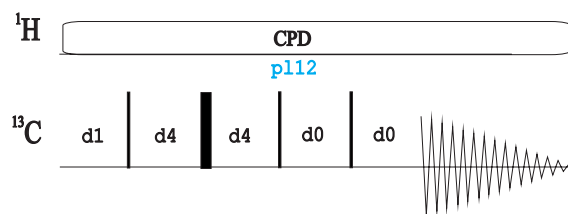

BRUKER PULSE PROGRAM CATALOGUE

NMRGuide

1D INVERSE EXPERIMENTS

- **Phase-Cycled:**

1D inverse DEPT with refocusing and no decoupling (**ideptnd**)

1D inverse INEPT without refocusing and without decoupling (**iineptnd**)

1D inverse INEPT with refocusing and decoupling (**iineptrd**)

1D HMQC with refocusing but not decoupling (**hmqcndrd1d** | HMQC1D)

1D HMQC without refocusing and without decoupling (**inv3nd1d/ hmqcnd1d**)

1D HMQC with refocusing and decoupling (**hmqcrd1d**)

1D HMQC using BIRD with refocusing and without decoupling (**hmqcbind1d**)

1D HMQC using BIRD with refocusing and without decoupling (**hmqcbindrd1d**)

1D HMQC using BIRD with refocusing and decoupling (**hmqcbird1d**)

1D DEPT-HMQC with refocusing and decoupling (**indecord1d**)

1D DEPT-HMQC using BIRD with refocusing and decoupling (**indecobird1d**)

- **Gradient-based:**

ge-1D HMQC with refocusing but not decoupling (**hmqcgpnd1d**)

ge-1D HSQC with refocusing and no decoupling (**hsqcgpnd1d**)

Any 2D or 3D pulse sequence can be used for 1D acquisition (mc commands)

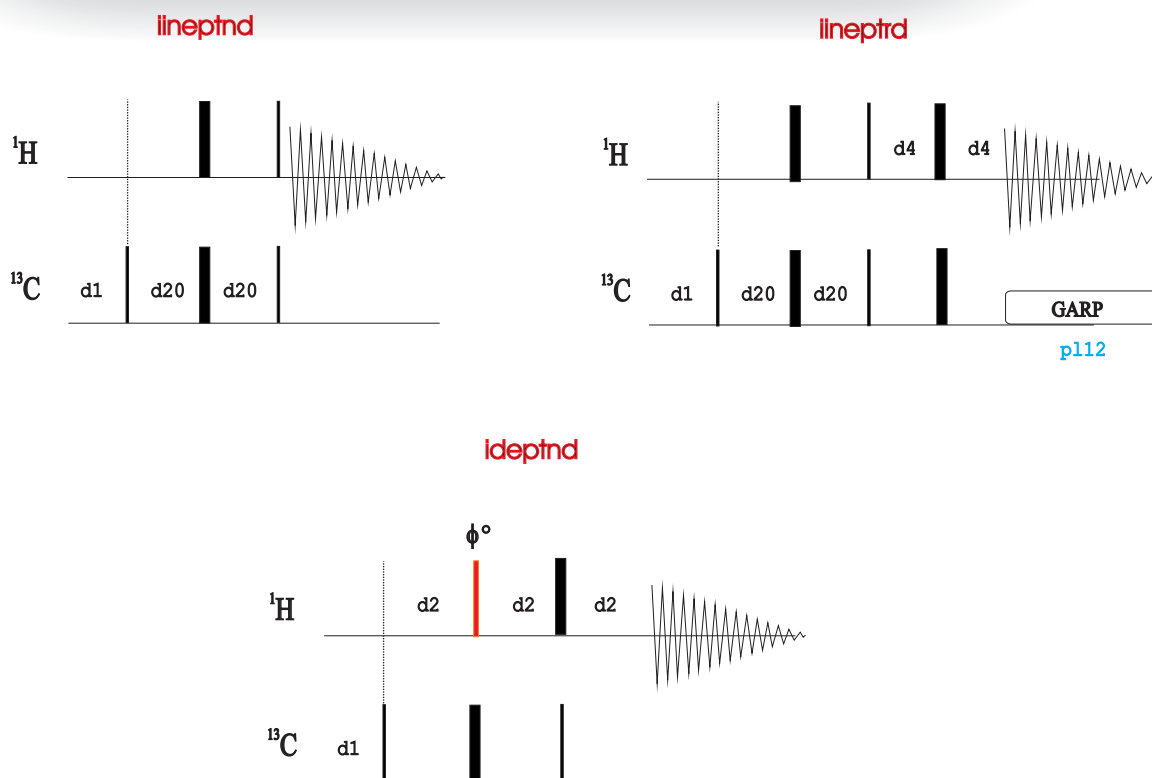

hmqcnd1d

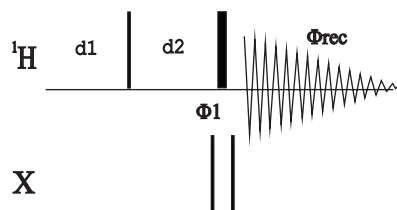

hmqcndrd1d

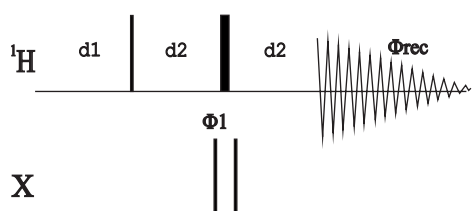

hmqcrd1d

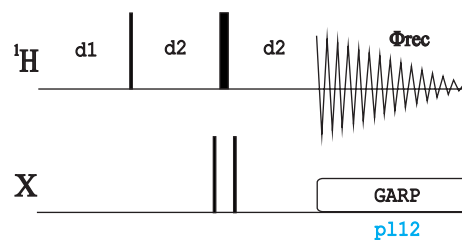

hmqcbind1d

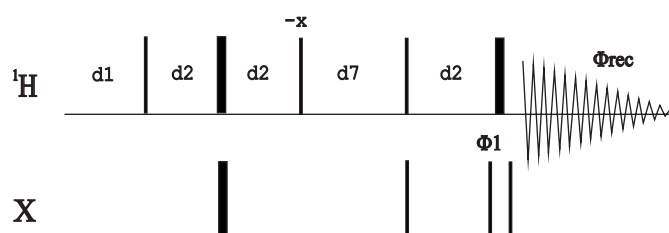

hmqcbindrd1d

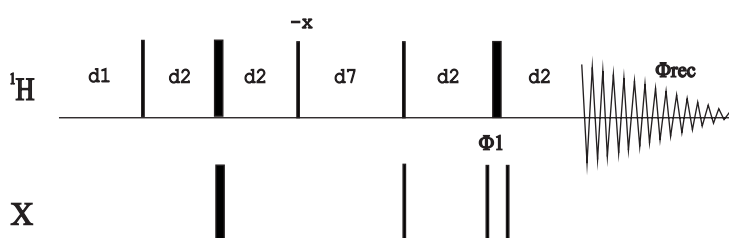

hmqcbird1d

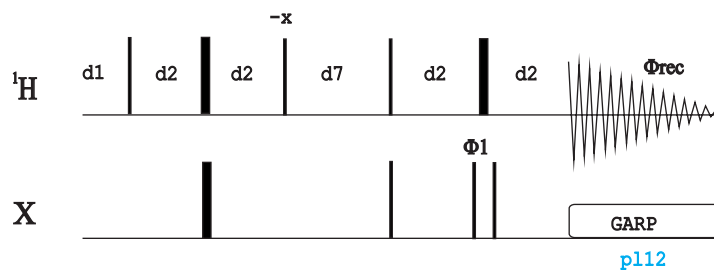

Indecord1d

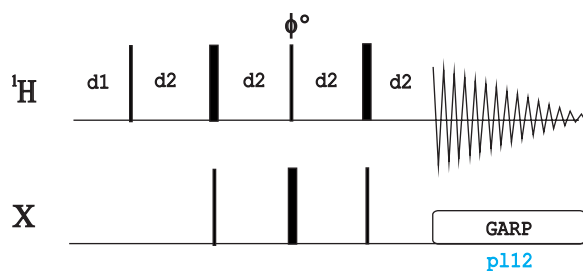

Indecobird1d

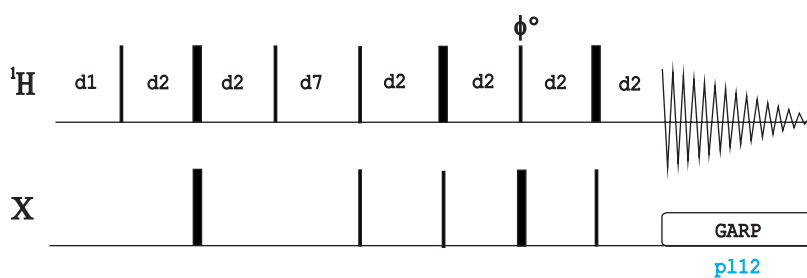

hmqcgpnd1d

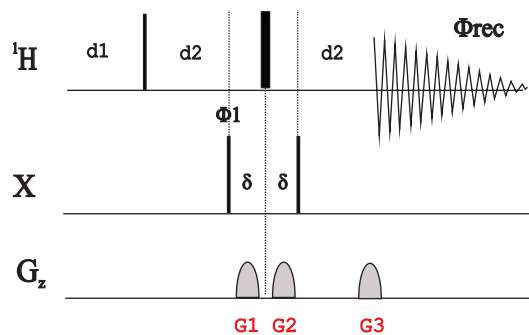

hsqcgpnd1d

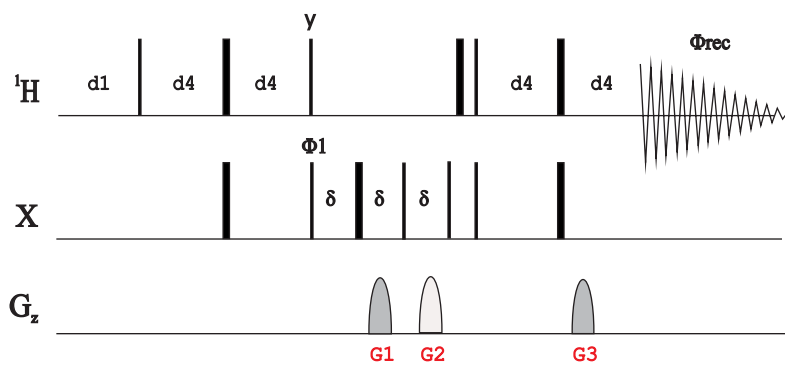

BRUKER PULSE PROGRAM CATALOGUE

NMRGuide

2D HMQC EXPERIMENTS

Phase-cycled:

Magnitude-mode 2D HMQC (**hmqcwf** | HMQC)
Magnitude-mode 2D HMQC without decoupling (**hmqcndwf**)
Magnitude-mode 2D HMQC using BIRD (**hmqcbiqf** | HMQCBI)
Magnitude-mode 2D HMQC using BIRD without decoupling (**hmqcbindwf**)
Phase-sensitive 2D HMQC (**hmqcph** | HMQCPH)
Phase-sensitive 2D HMQC without decoupling (**hmqcndph**)
Phase-sensitive 2D HMQC using BIRD (**hmqcbiph** | HMQCBIPH)
Phase-sensitive 2D HMQC using BIRD without decoupling (**hmqcbindph**)

Phase-cycled and solvent suppression

From f2 channel:

Phase-sensitive 2D HMQC with presaturation (**hmqcphpr** | HMQCPHPR)
Phase-sensitive 2D HMQC using BIRD and presaturation (**hmqcbiphpr**) /
hmqcbiphpr2)
Phase-sensitive 2D HMQC with 1-1 water suppression (**hmqcph11**)

From f3 channel:

Phase-sensitive 2D ^1H - ^{15}N HMQC (**hmqcf3ph**)
Phase-sensitive 2D ^1H - ^{15}N HMQC using presaturation (**hmqcf3phpr**)
Phase-sensitive 2D ^1H - ^{15}N HMQC using BIRD (**hmqcbif3ph**)
Phase-sensitive 2D ^1H - ^{15}N HMQC using decoupling in a third f2 channel
(**hmqcfbph**)

Gradient-based:

From f2 channel:

Magnitude-mode ge-2D HMQC (**hmqcgpwf** | HMQCGP)
Phase-sensitive ge-2D HMQC using z-filter (**hmqcgpph**)
Phase-sensitive ge-2D HMQC using echo-antiecho (**hmqcetgp**)
Phase-sensitive ge-2D HMQC using echo-antiecho with adiabatic refocusing (**hmqcetgp.2**)
Phase-sensitive ge-2D HMQC using PEP (**hmqcetgpsi**)
Phase-sensitive ge-2D HMQC using PEP and shorter overall timing (**hmqcetgpsi.2**)

From f3 channel:

Phase-sensitive ge-2D ^1H - ^{15}N HMQC using echo-antiecho (**hmqcetf3gp**)
Phase-sensitive ge-2D ^1H - ^{15}N HMQC using PEP (**hmqcetf3gpsi**)
Phase-sensitive ge-2D ^1H - ^{15}N HMQC using PEP and shorter overall timing(
hmqcetf3gpsi.2)

Gradient-based and solvent suppression

Phase-sensitive ge-2D ^1H - ^{15}N HMQC using WATERGATE (3-9-19)
(**hmqcf3gpph19**)

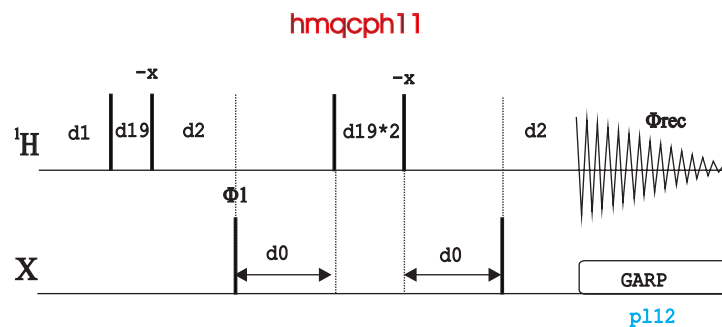
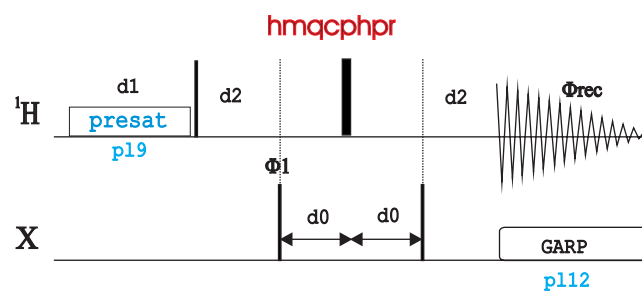
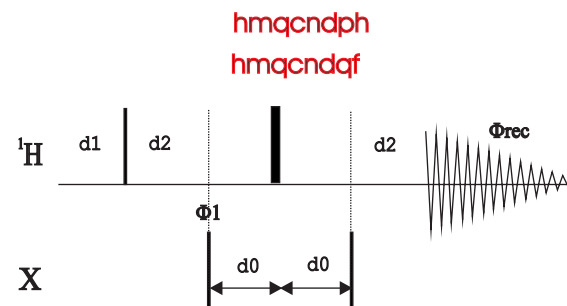
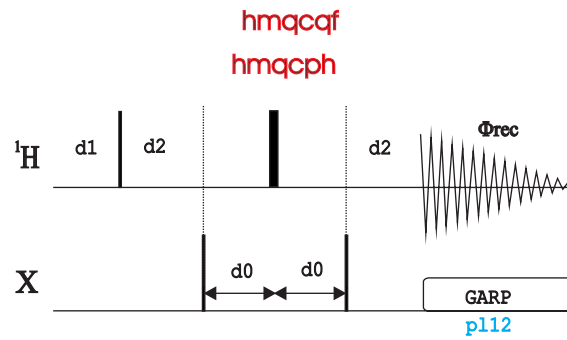
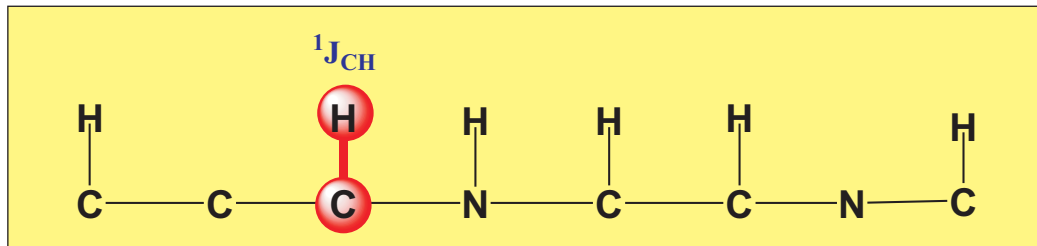

hmqcblph
 hmqcblqf

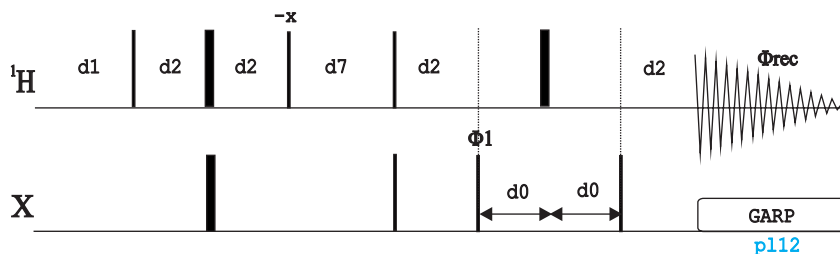

hmqcblndph
 hmqcblndqf

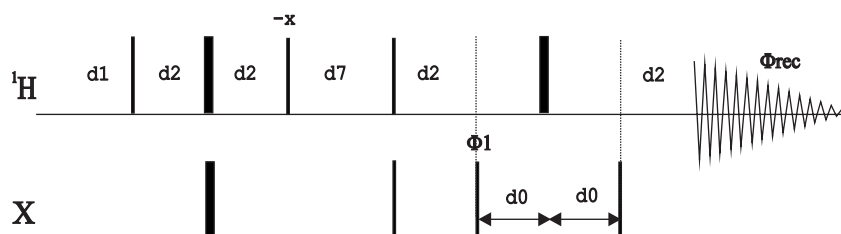

hmqcblphpr

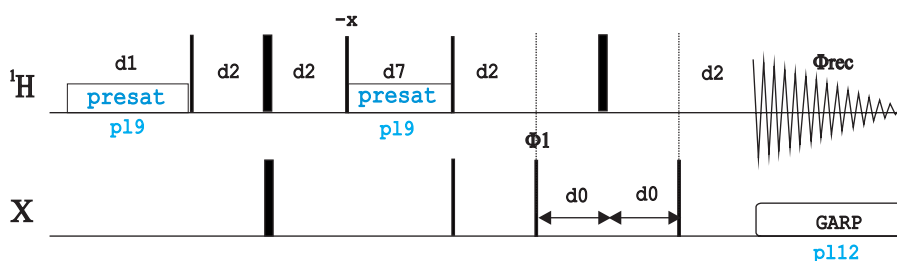

hmqcblphpr2

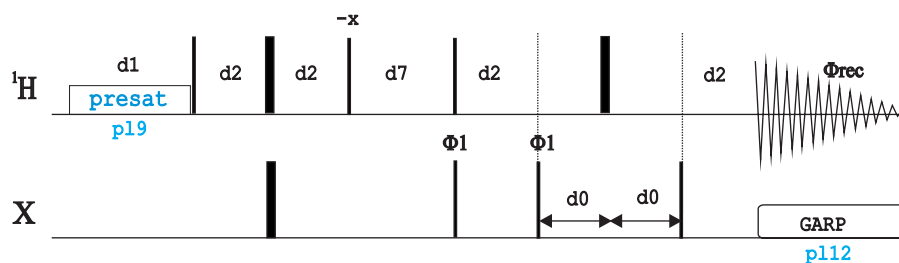

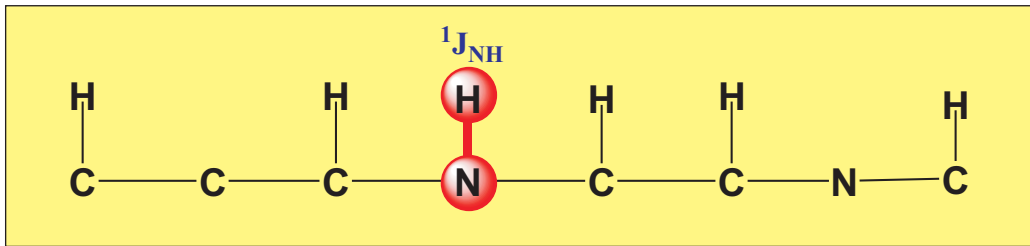

hmqcf3ph

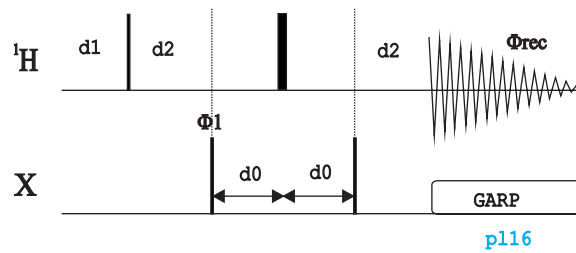

hmqcf3phpr

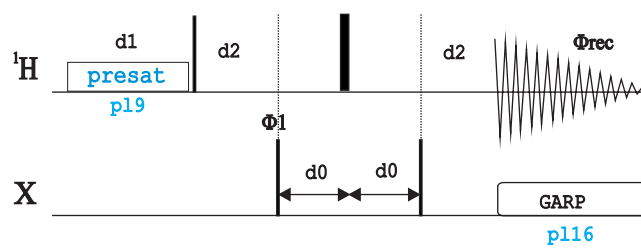

hmqcbf3ph

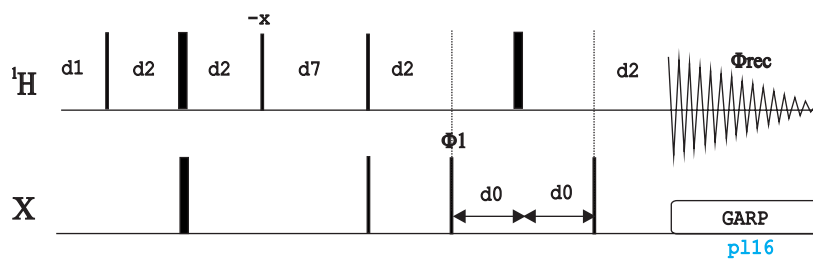

hmqcfbph

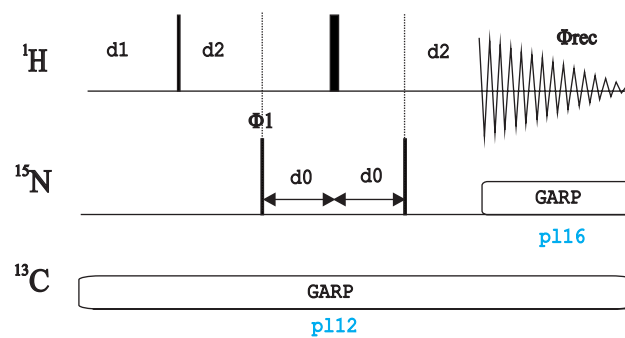

hmqcgpqf

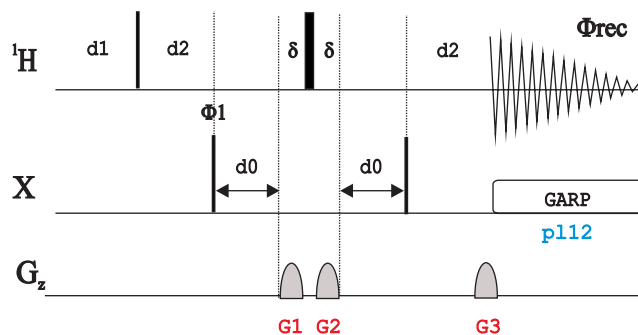

hmqcgpqh

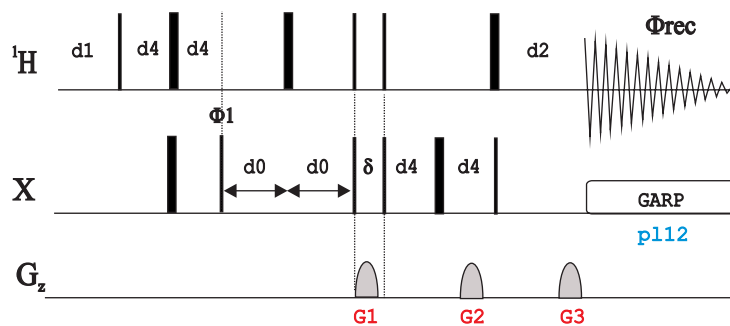

hmqcf3gpqh19

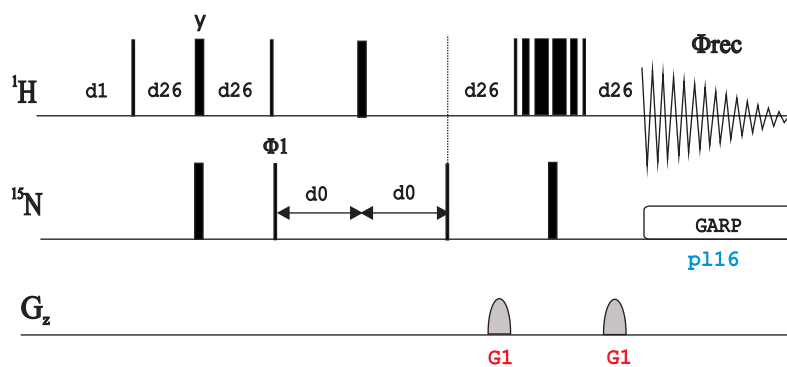

hmqcetgp

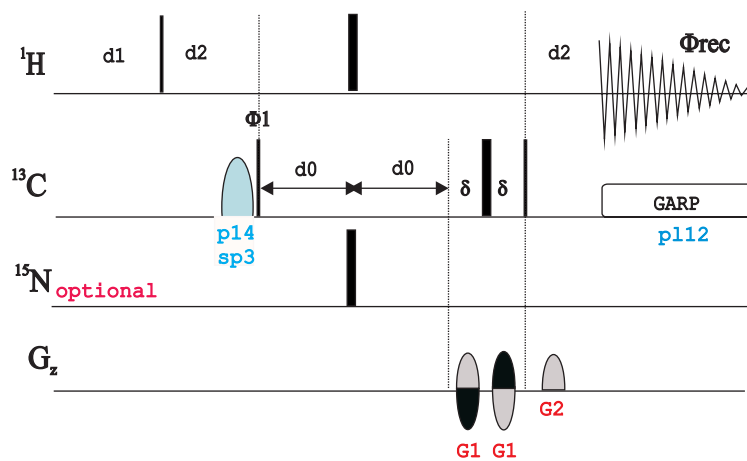

hmqcetgp.2

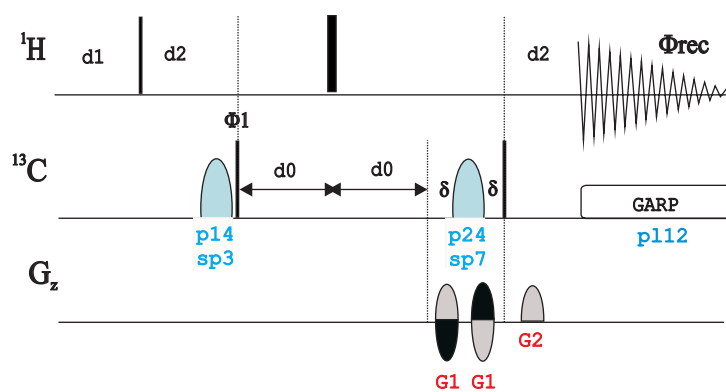

hmqcetgpsi

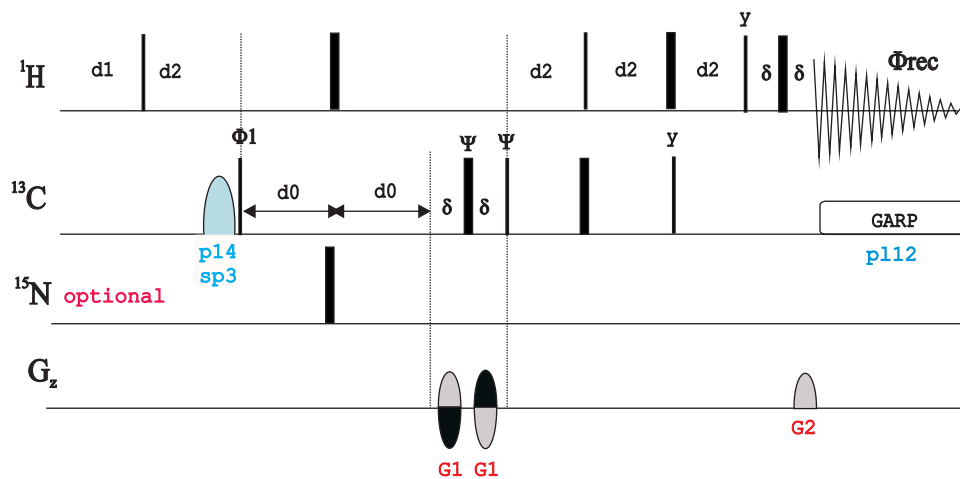

hmqcetgpsl.2

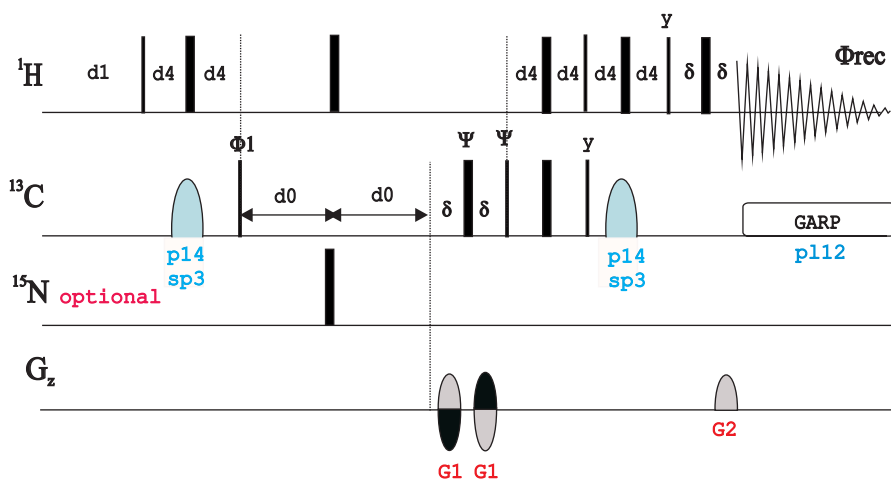

hmqcetf3gp

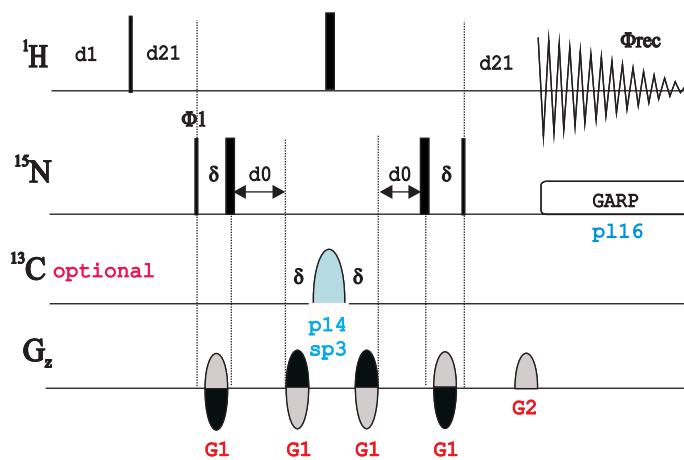

hmqcetf3gpsl

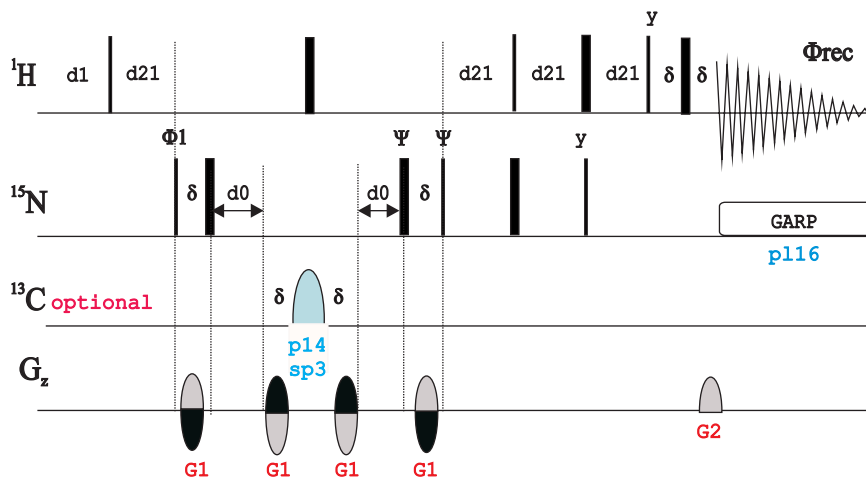

hmqcetf3gpsl.2

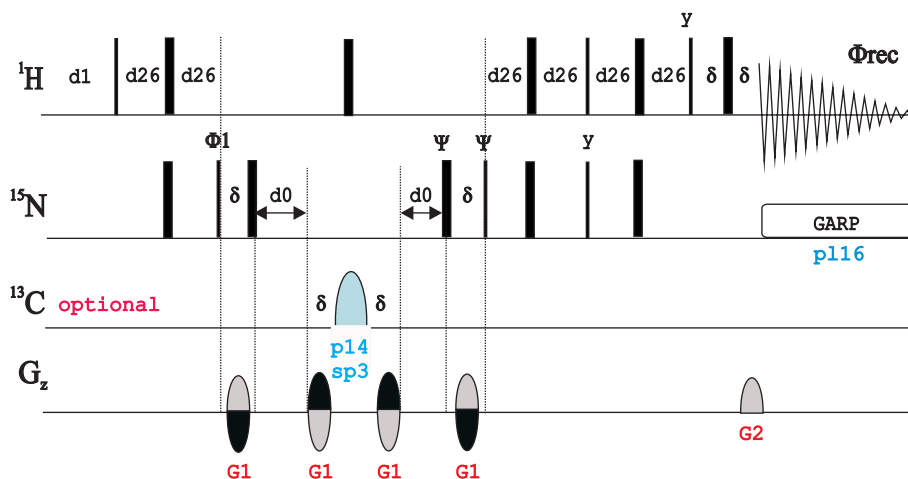

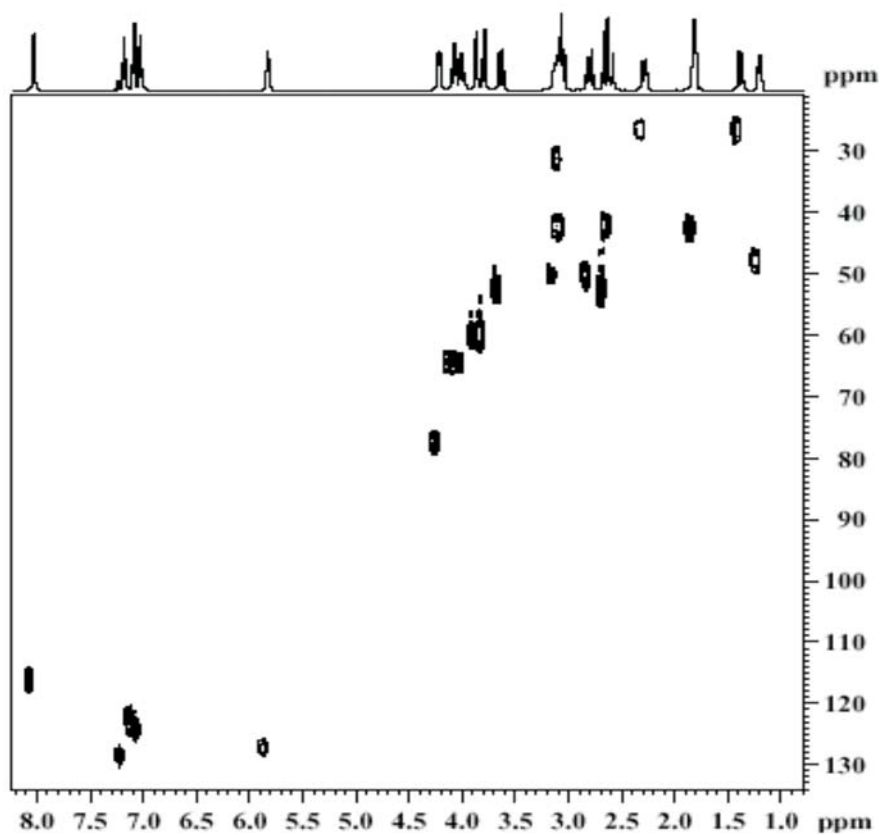

BRUKER PULSE PROGRAM CATALOGUE

NMRGuide

2D DEPT-HMQC EXPERIMENTS

Phase-sensitive 2D DEPT-HMQC (**indecoph**)
 Phase-sensitive 2D DEPT-HMQC using BIRD (**indecobiph**)
 Phase-sensitive 2D DEPT-HMQC-TOCSY using BIRD (**indecobimlph**)

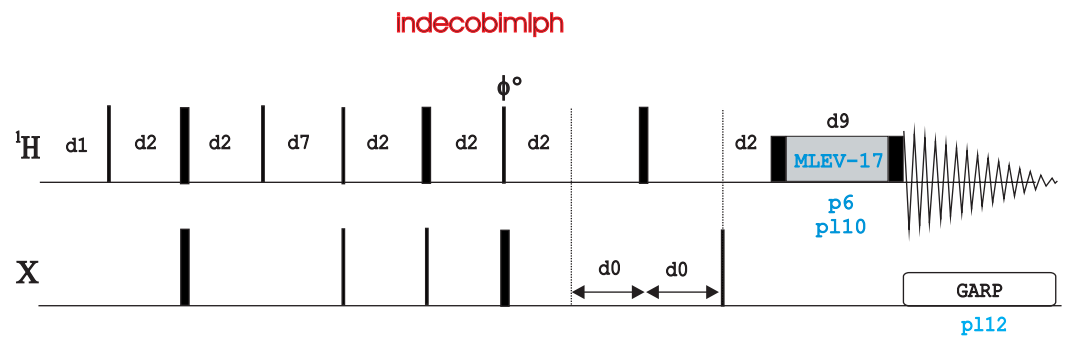
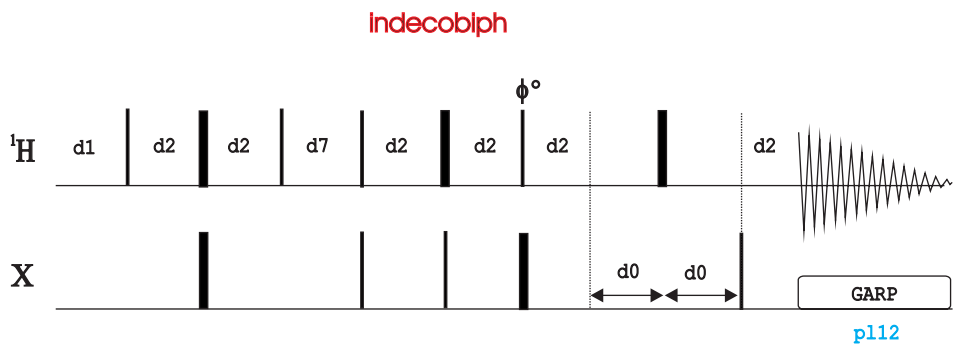
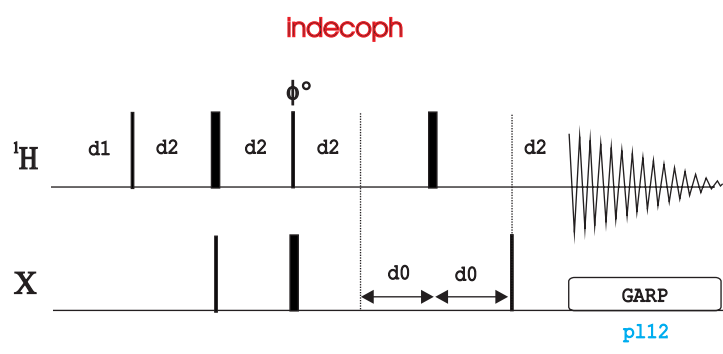

BRUKER PULSE PROGRAM CATALOGUE

NMRGuide

2D HSQC EXPERIMENTS

FROM F2 CHANNEL

- **Phase-cycled:**

Phase-sensitive 2D HSQC (**hsqcph**)

- **Phase-cycled and solvent suppression:**

Phase-sensitive 2D HSQC with presaturation (**hsqcphpr**)

Phase-sensitive 2D HSQC with off-resonance presaturation (**hsqcphps**)

- **Gradient-based:**

Phase-sensitive ge-2D HSQC using z-filter and selection before t1 (**hsqcgpph** | **HSQCGP**)

Phase-sensitive ge-2D HSQC using z-filter and selection after t1 (**hsqcgpph2**)

Phase-sensitive ge-2D HSQC using echo-antiecho (**hsqcetgp** | **HSQCETGP**)

Phase-sensitive ge-2D HSQC using echo-antiecho and adiabatic pulses for inversion

(**hsqcetgpsp**)

Phase-sensitive ge-2D HSQC using echo-antiecho and adiabatic pulses for inversion and refocusing(**hsqcetgpsp.2**)

Phase-sensitive ge-2D HSQC using echo-antiecho and adiabatic pulses for inversion and refocusing and BS effects(**hsqcetgpsp.3**)

Phase-sensitive ge-2D HSQC using PEP (**hsqcetgpsp**)

Phase-sensitive ge-2D HSQC using PEP with gradients in back-inept (**hsqcetgpsp2**)

Phase-sensitive ge-2D HSQC using PEP and adiabatic pulses for inversion(**hsqcetgpsisp** |

HSQCETGPSISP)

Phase-sensitive ge-2D HSQC using PEP and adiabatic pulses for inversion with gradients in

back-inept (**hsqcetgpsisp2**)

Phase-sensitive ge-2D HSQC using PEP and adiabatic pulses for inversion and refocusing

(**hsqcetgpsisp.2** | **HSQCETGPSISP.2**)

Phase-sensitive ge-2D HSQC using PEP and adiabatic pulses for inversion and refocusing with

gradients in back-inept (**hsqcetgpsisp2.2**)

ge-2D ¹H-X HSQC experiment with X-Y-decoupling during acquisition and with

selective Cb/C=O decoupling. (**hsqcdhetgpsp**)

FROM F3 CHANNEL

- **Phase-cycled:**

Phase-sensitive 2D ^1H - ^{15}N HSQC (**hsqcf3ph**)

- **Phase-cycled and solvent suppression:**

Phase-sensitive 2D ^1H - ^{15}N HSQC using presaturation (**hsqcf3phpr**)

- **Gradient-based:**

Phase-sensitive ge-2D ^1H - ^{15}N HSQC using echo-antiecho (**hsqcetf3gp** | **HSQCETF3GP**)

Phase-sensitive ge-2D ^1H - ^{15}N HSQC using PEP (**hsqcetf3gpsi** | **HSQCETF3GPSI**)

Phase-sensitive ge-2D ^1H - ^{15}N HSQC using PEP with gradients in back-inept (**hsqcetf3gpsi2**)

Phase-sensitive ge-2D ^1H - ^{15}N HSQC using XY16-CPMG(**hsqcetf3gpxy**, **hsqcetf3gpxy.2**)

- **Gradient-based and solvent suppression**

Phase-sensitive ge-2D ^1H - ^{15}N HSQC using water flip-back and echo-antiecho (**hsqcetfpf3gp** | **HSQCETFPF3GP**)

Phase-sensitive ge-2D ^1H - ^{15}N HSQC using water flip-back and PEP (**hsqcetfpf3gpsi** | **HSQCETFPF3GPSI**)

Phase-sensitive ge-2D ^1H - ^{15}N HSQC using water flip-back and PEP with gradients in back-inept (**hsqcetfpf3gpsi2**)

Phase-sensitive ge-2D ^1H - ^{15}N HSQC using WATERGATE (3-9-19) (**hsqcf3gpph19**)
Fast-HSQC, Phase-sensitive ge-2D ^1H - ^{15}N HSQC using WATERGATE (3-9-19) (**fhsqcf3gpph** | **FHSQCF3GPPH**)

Phase-sensitive ge-2D ^1H - ^{15}N HSQC using water flip-back and WATERGATE (selective pulse) (**hsqcfpf3gpphwg** | **HSQCFFP3GPPHWG**)

hsqcph

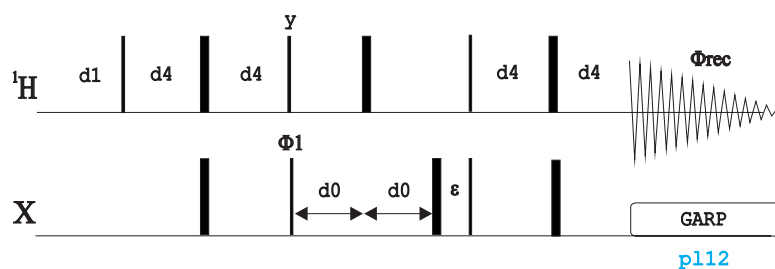

hsqcf3ph

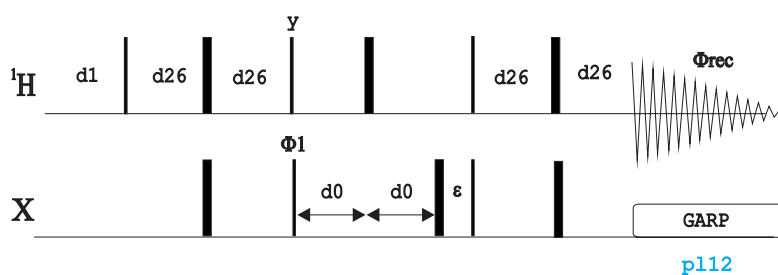

hsqcphpr

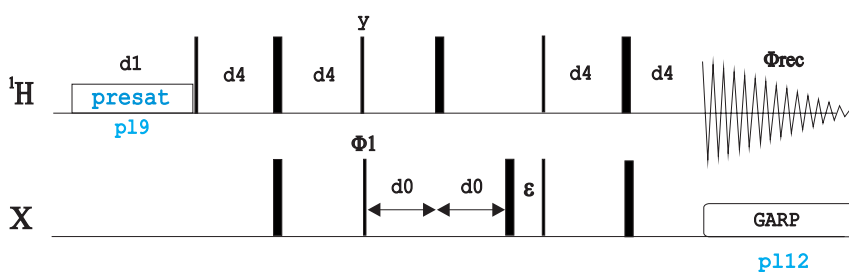

hsqcf3phpr

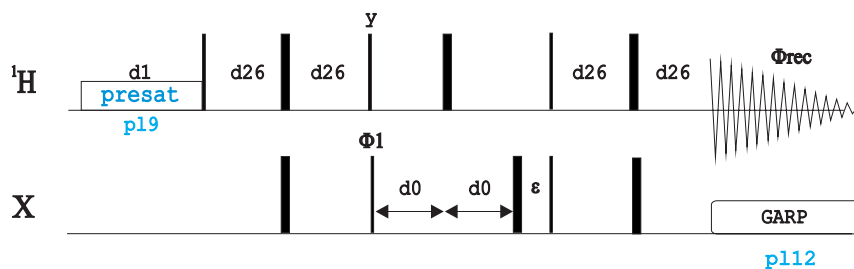

hsqcphps

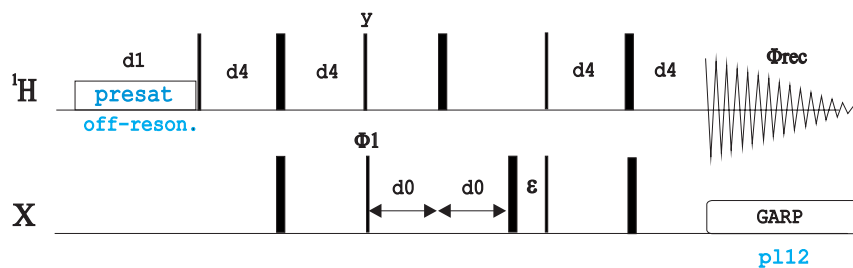

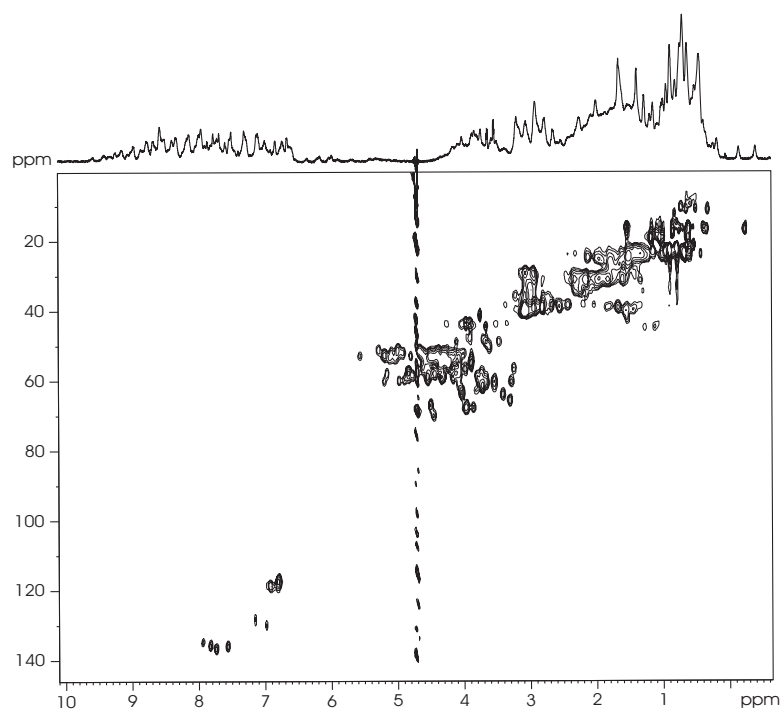
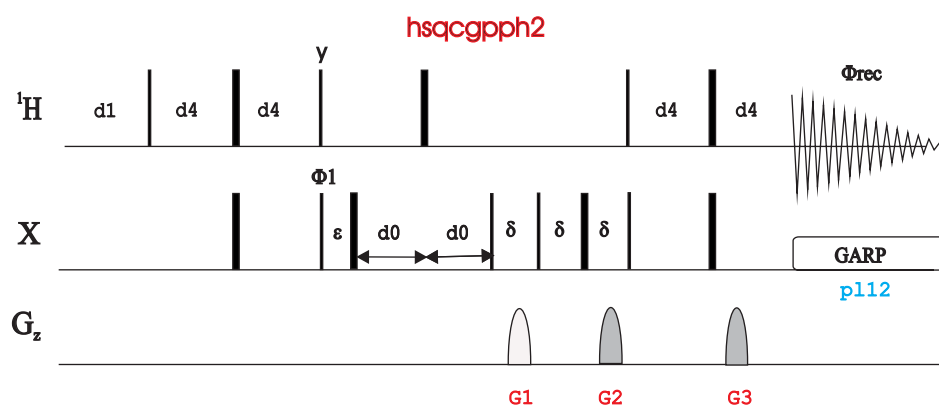
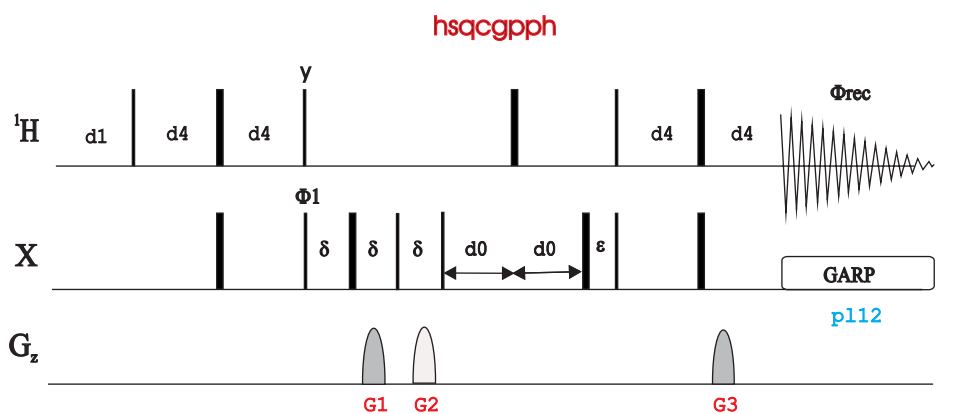
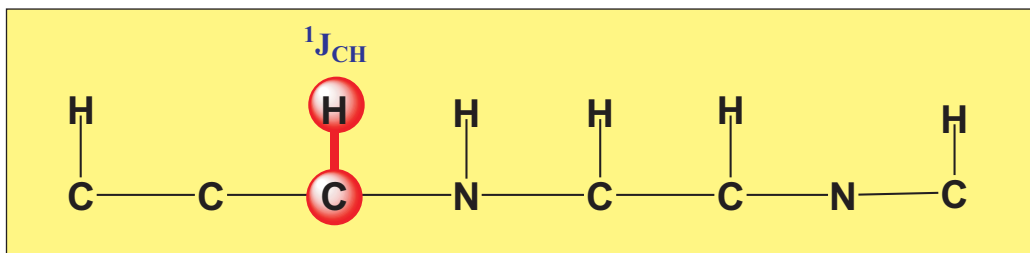

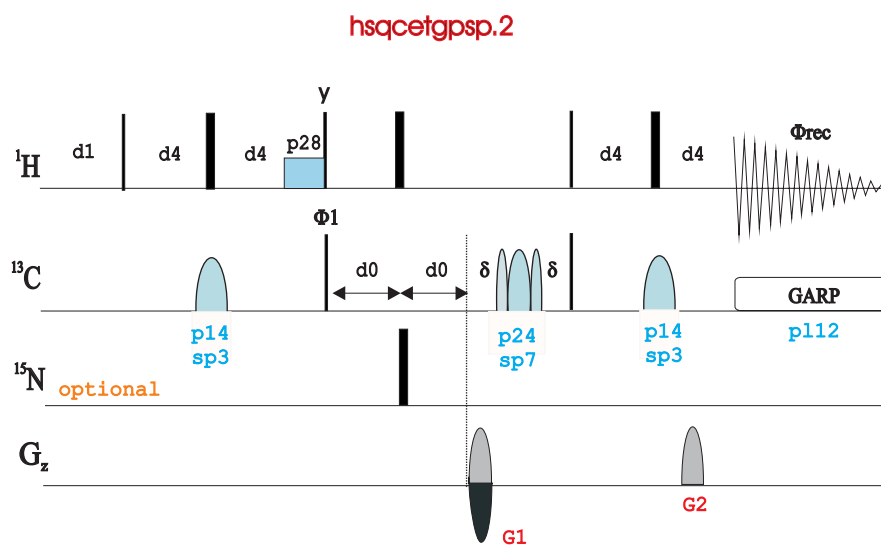
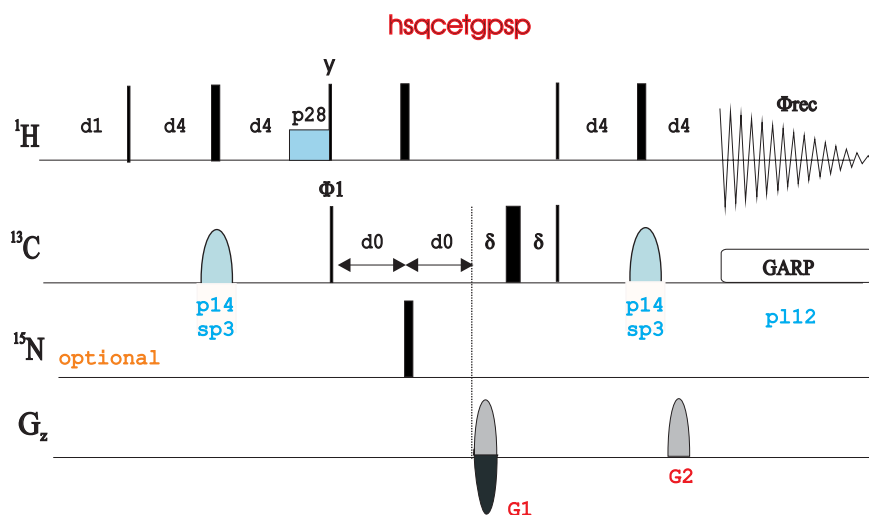
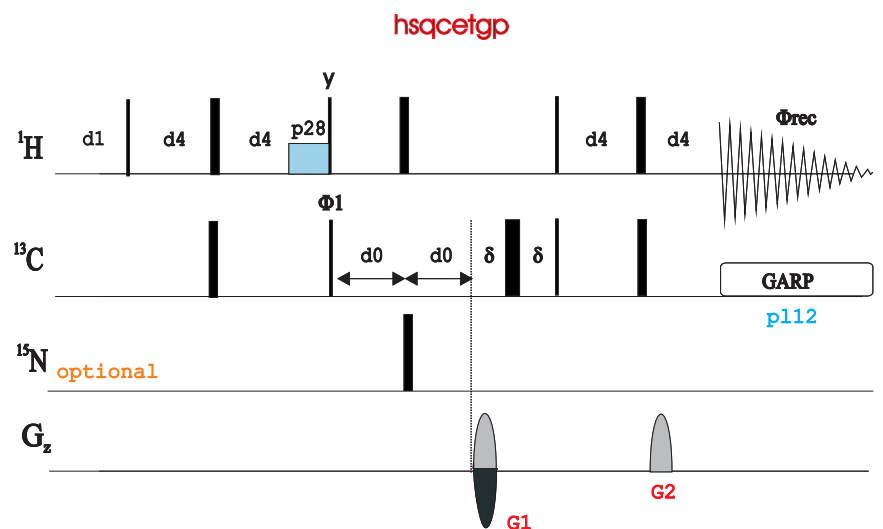

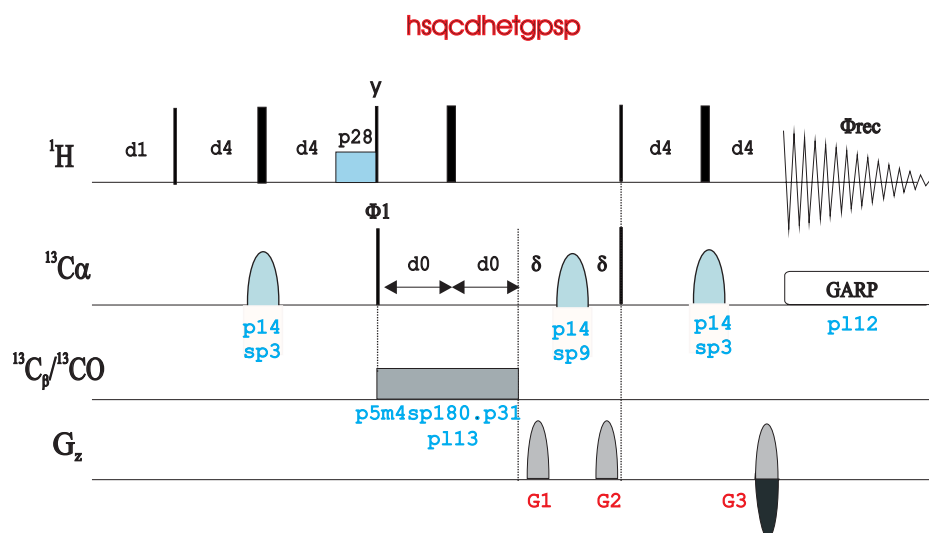
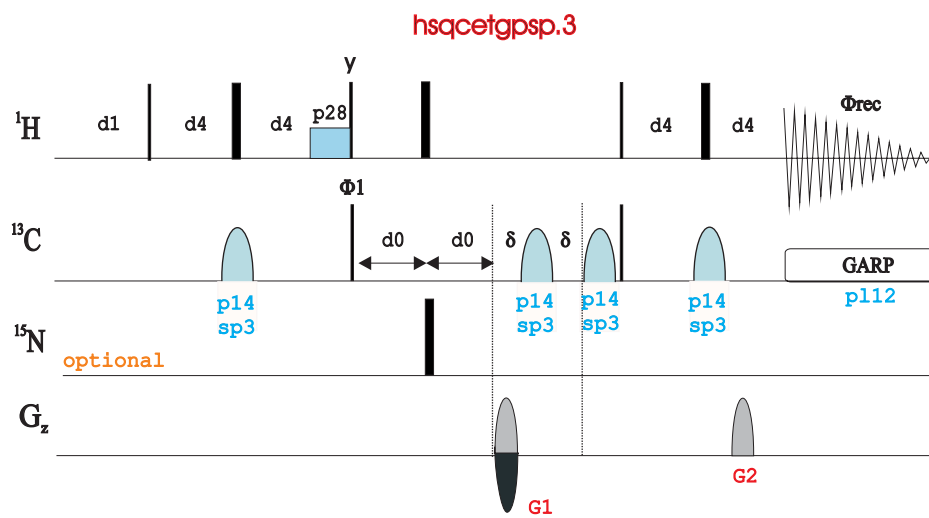

hsqcetgpsi

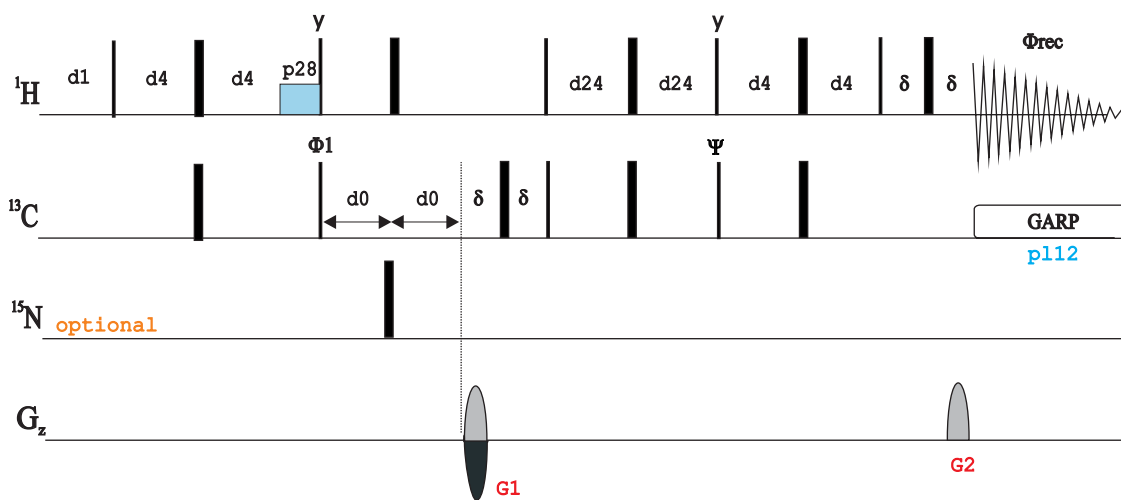

hsqcetgpsi2

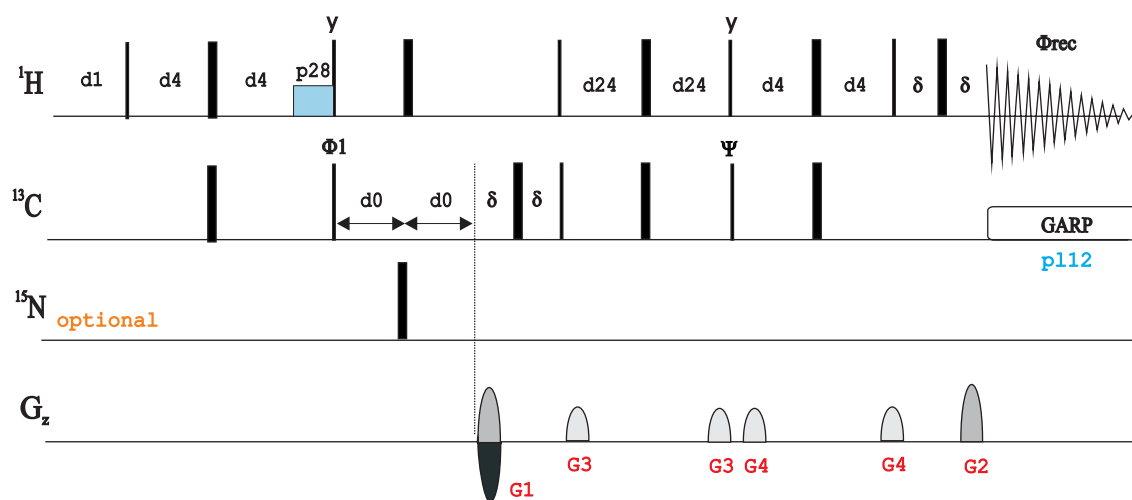

hsqcetgpsisp

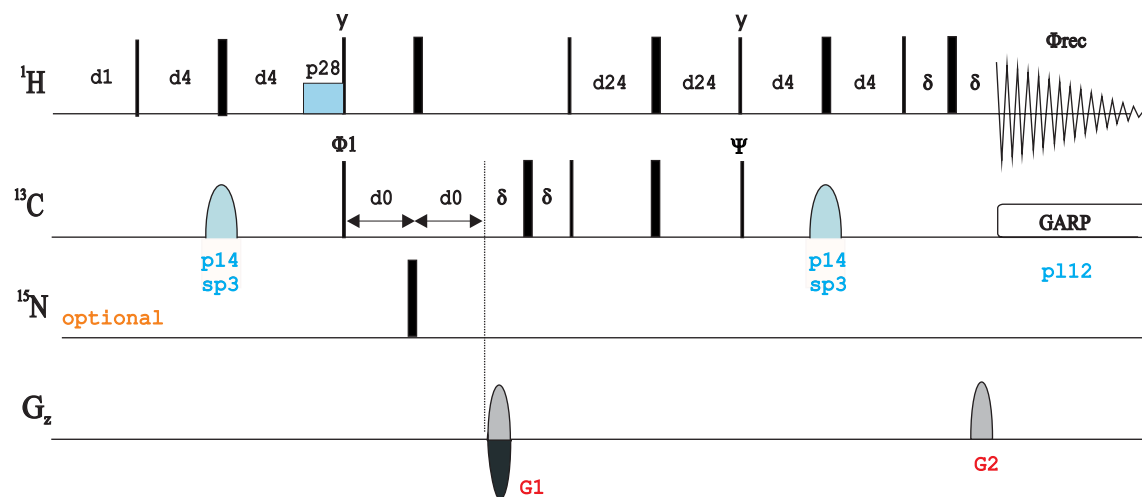

hsqcetgpsisp2

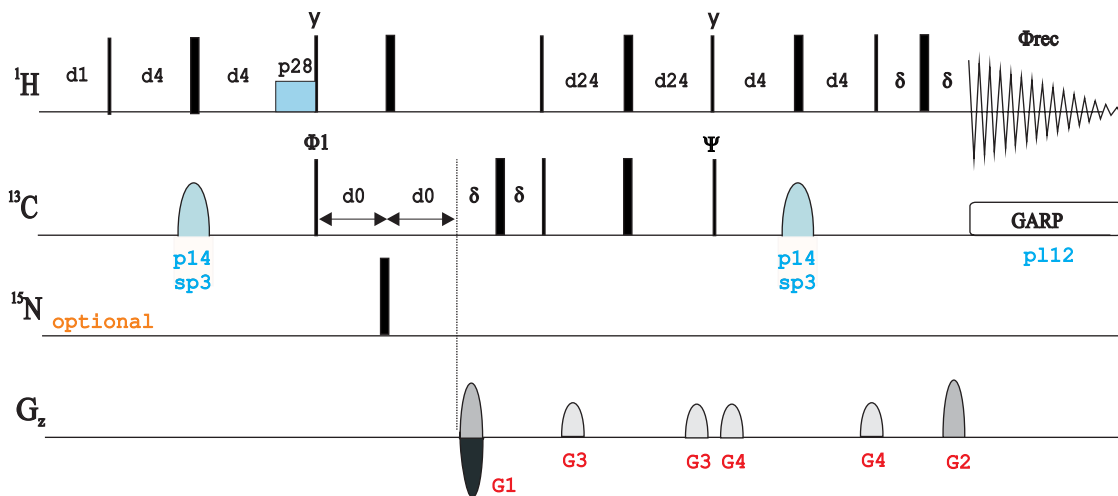

hsqcetgpsisp.2

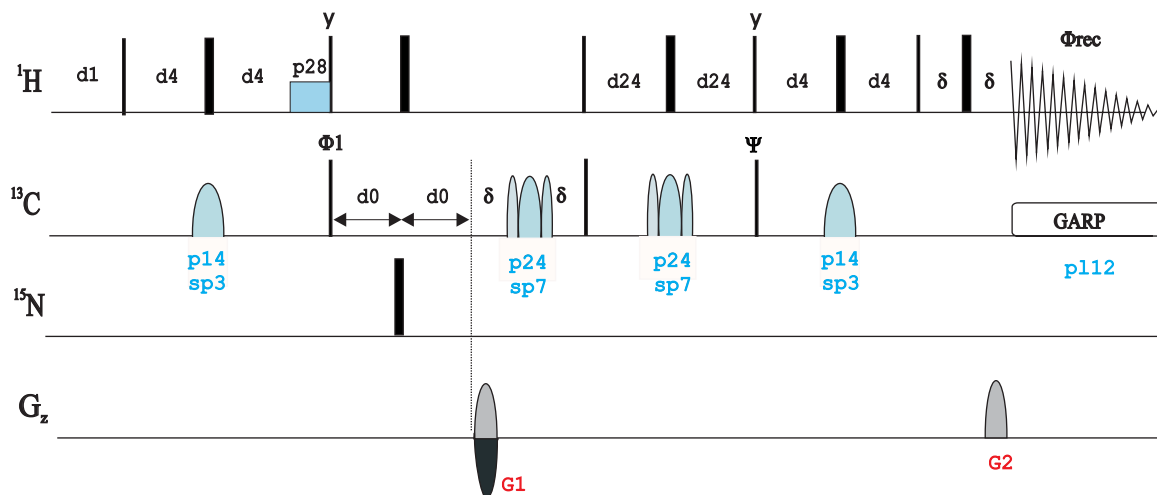

hsqcetgpsisp2.2

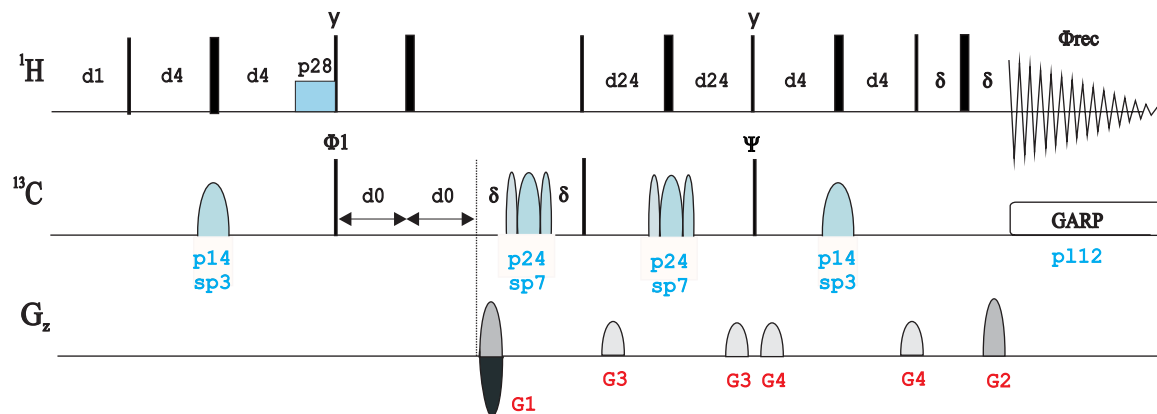

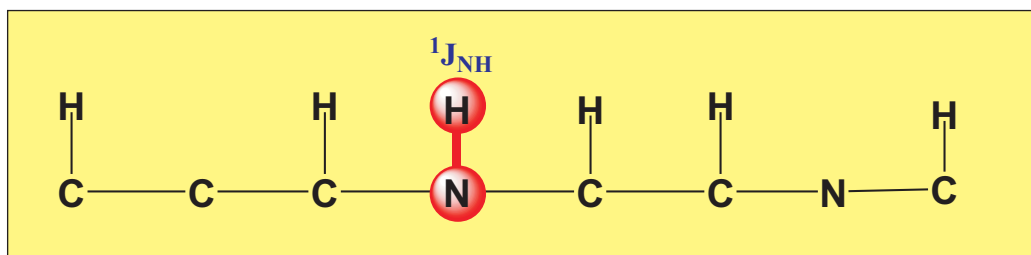

hsqcetf3gp

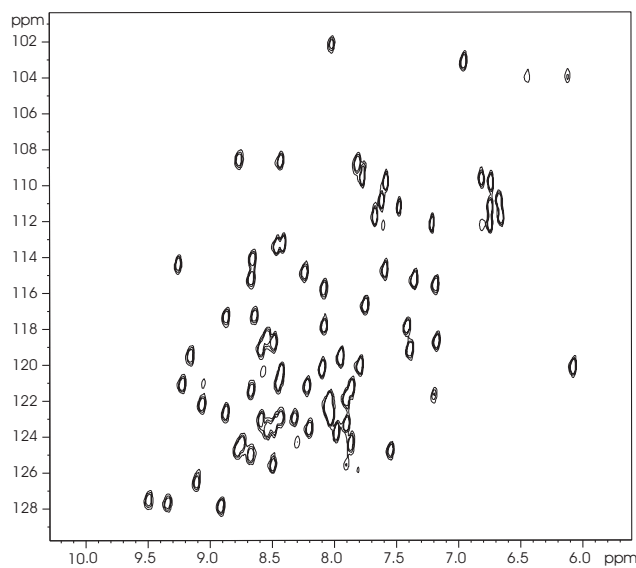
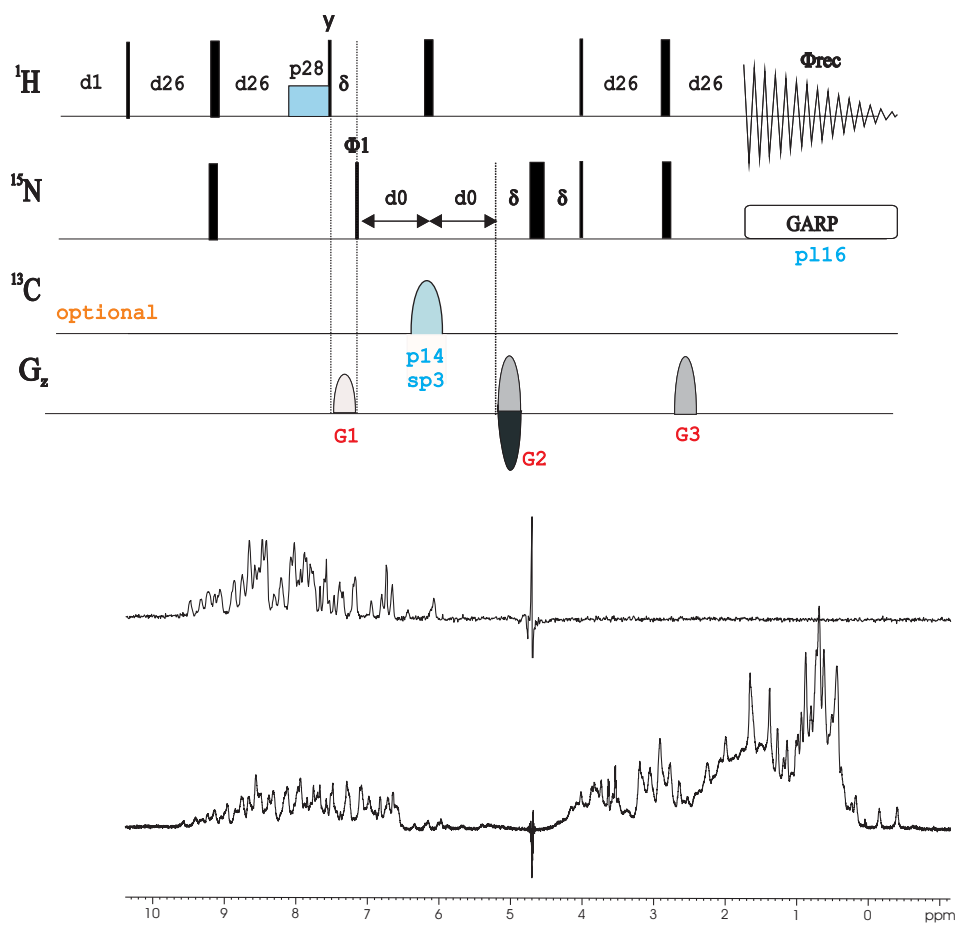

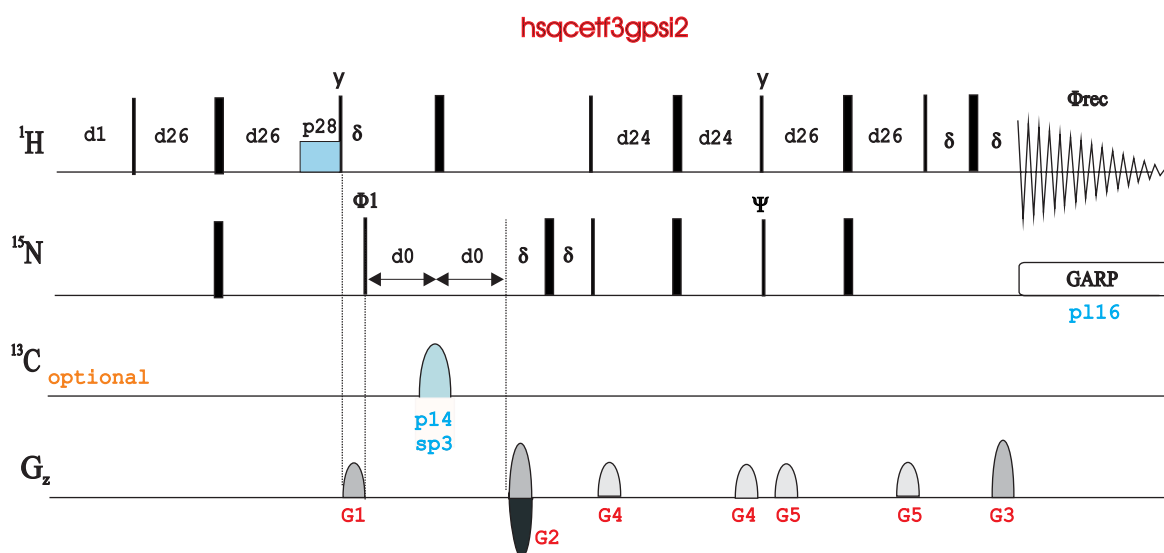
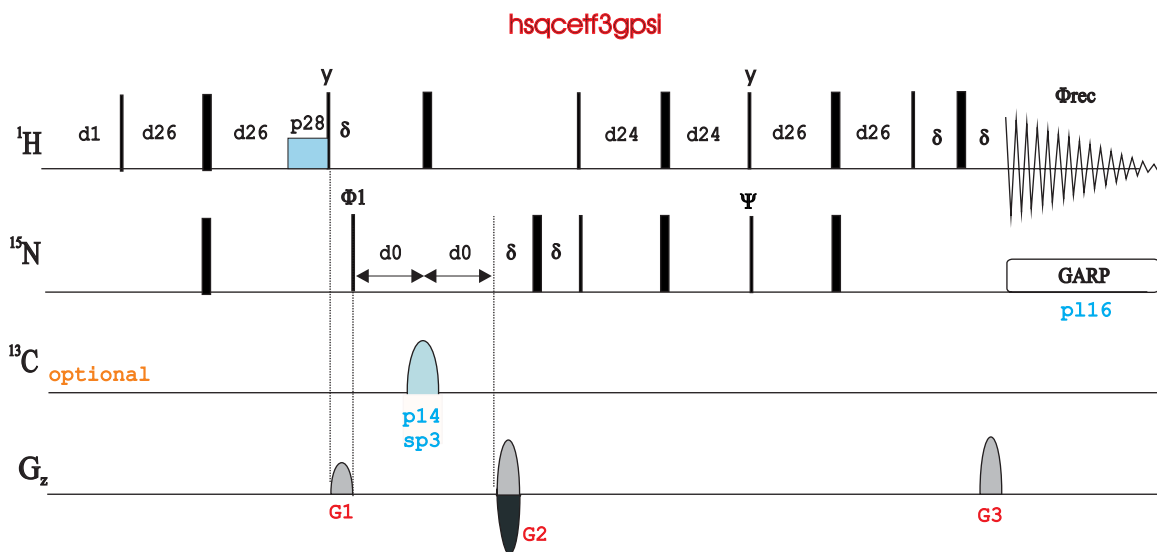

^1H - ^{15}N HSQC Ubiquitin in 1mM 500 MHz
 Optional ^{13}C decoupling during t1
 in doubly-labeled proteins
 zgoptns -DLABEL_CN in eda

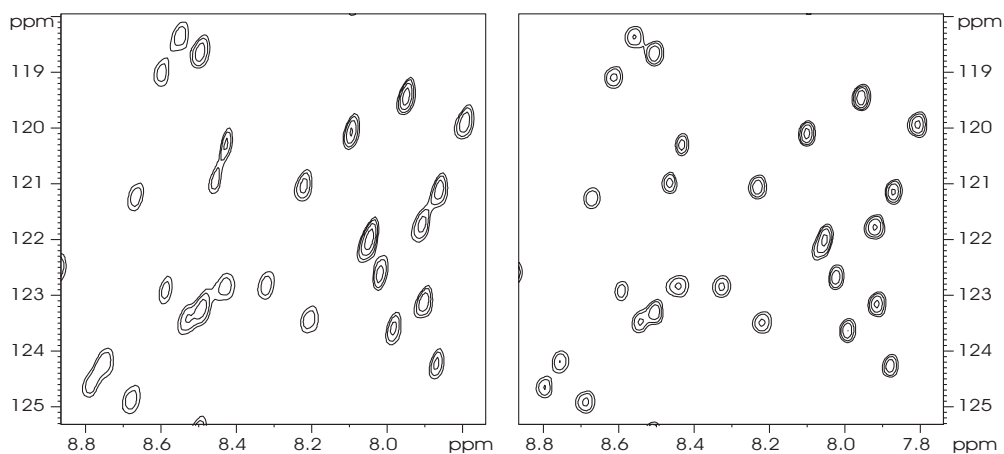

hsqcetf3gpsl

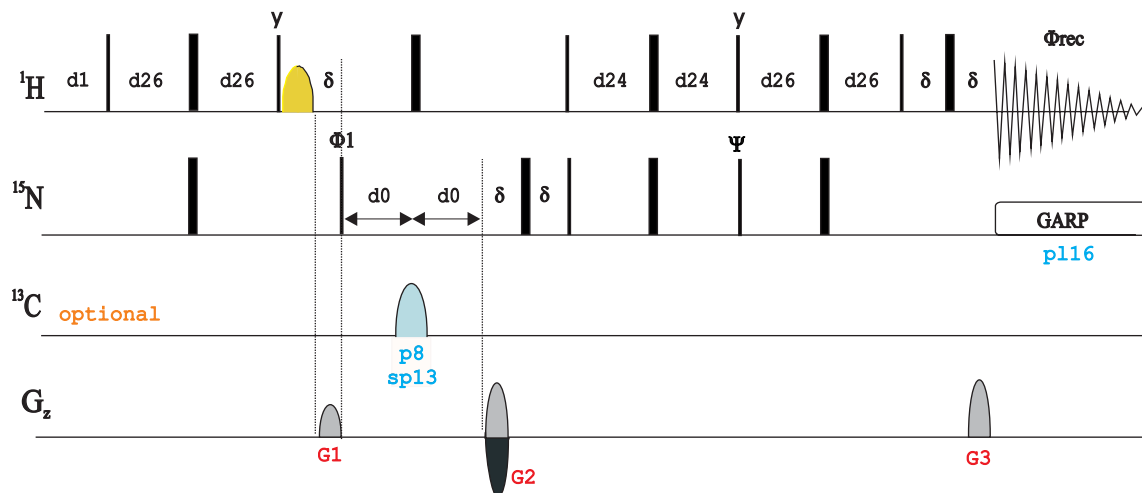

hsqcetf3gpsl2

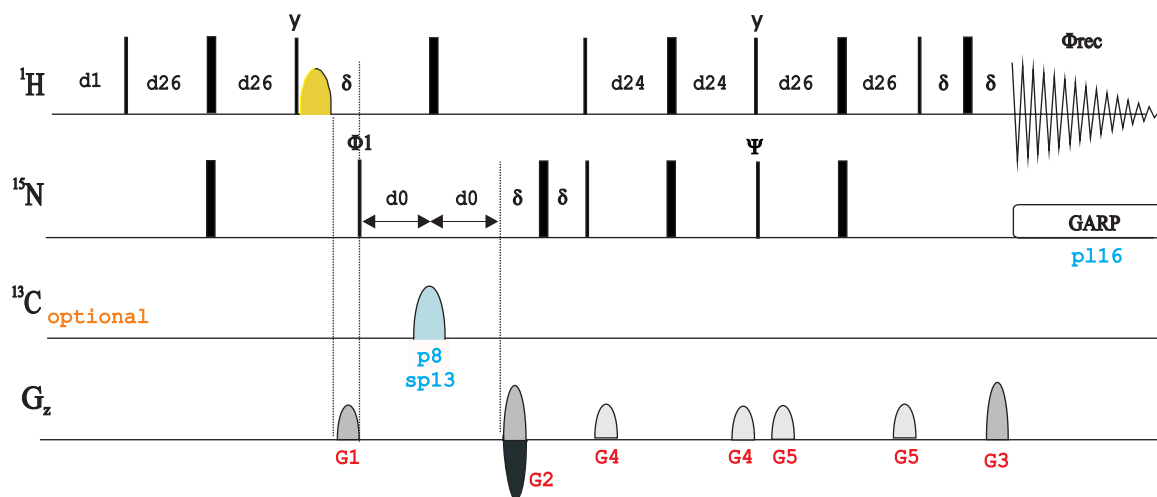

fhsqcf3gpph

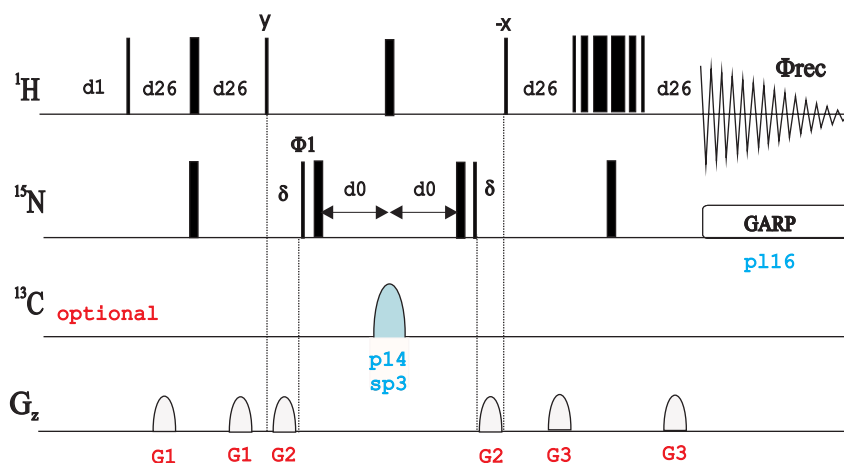

hsqcf3gpph19

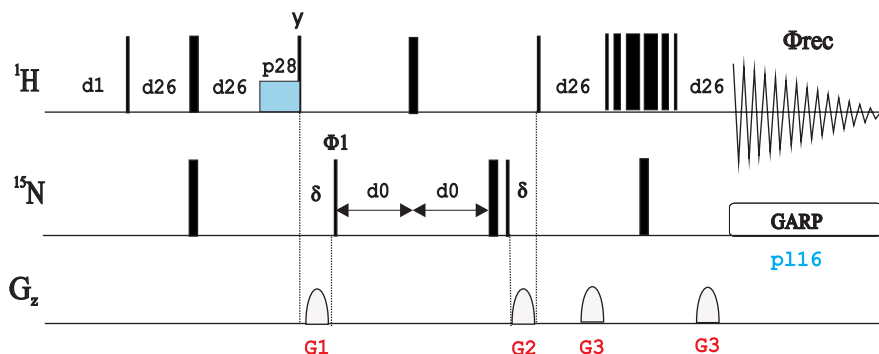

hsqcf3gpph19

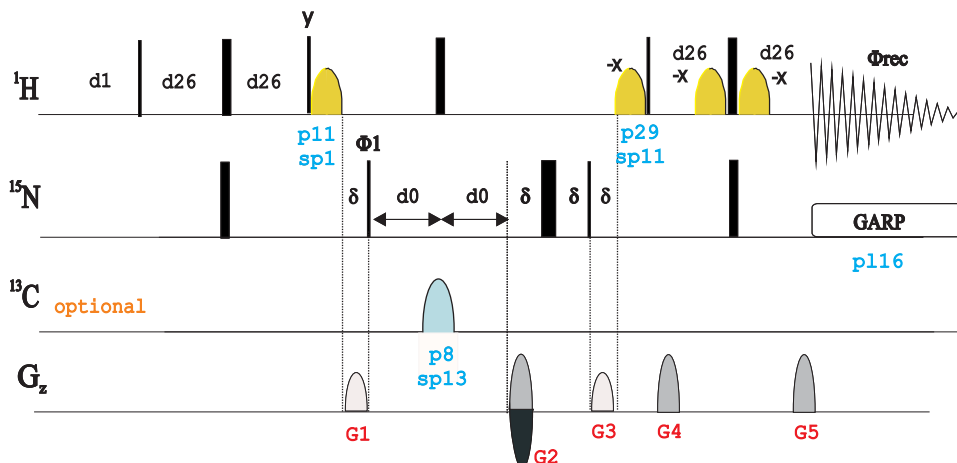

hsqcf3gpph19

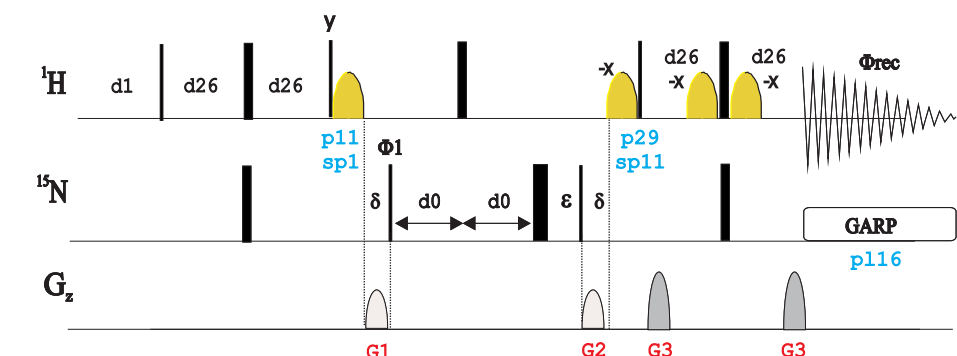

hsqcetf3gpxy

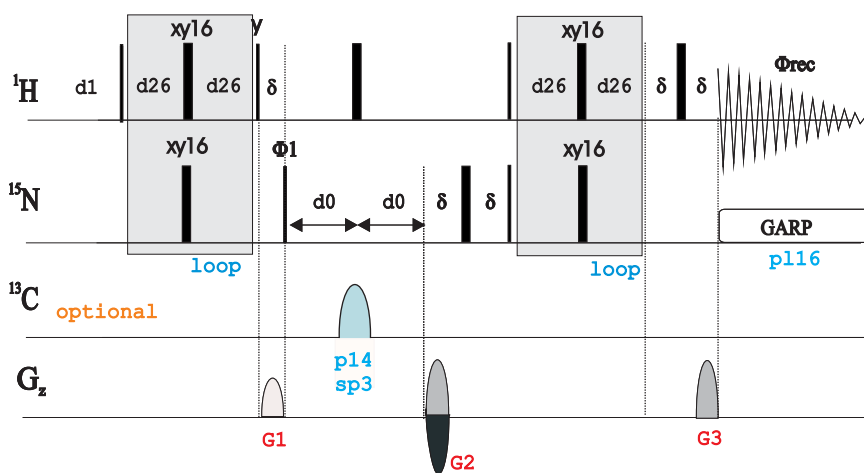

hsqcetf3gpxy.2

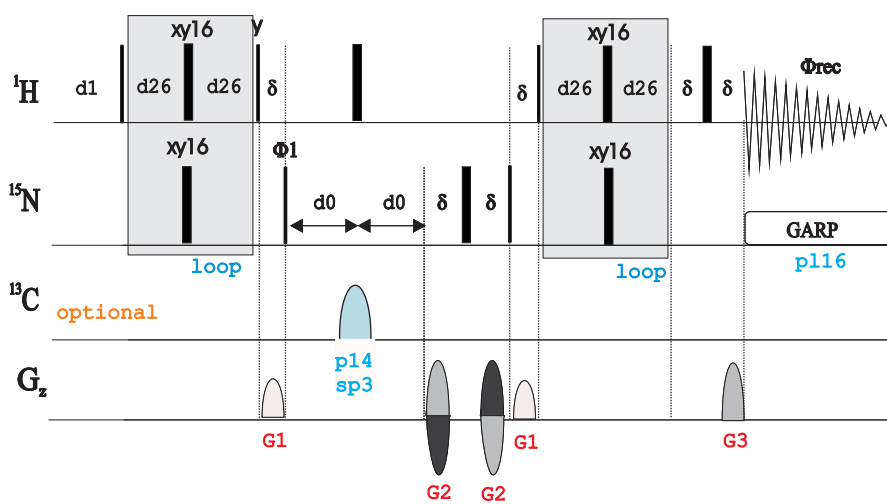

BRUKER PULSE PROGRAM CATALOGUE

NMRGuide

2D MULTIPLICITY-EDITED
HSQC EXPERIMENTS

Gradient-enhanced form f2 channel

Phase-sensitive ge-2D multiplicity-edited HSQC using z-filter (**hsqcedgpph** | HSQCEDGPPH)

Phase-sensitive ge-2D multiplicity-edited HSQC using echo-antiecho (**hsqcedetgp** | HSQCEDETGP)

Phase-sensitive ge-2D multiplicity-edited HSQC using echo-antiecho and adiabatic pulses (**hsqcedetgpsp**)

Phase-sensitive ge-2D multiplicity-edited HSQC using echo-antiecho and inversion and matched sweep adiabatic pulses (**hsqcedetgpsp.3**)

Phase-sensitive ge-2D multiplicity-edited HSQC using PEP and adiabatic inversion pulses (**hsqcedetgpsisp**)

Phase-sensitive ge-2D multiplicity-edited HSQC using PEP and adiabatic inversion and refocusing pulses (**hsqcedetgpsisp.2**)

Phase-sensitive ge-2D multiplicity-edited HSQC using PEP and adiabatic inversion pulses with gradients in back-inept (**hsqcedetgpsisp2**)

Phase-sensitive ge-2D multiplicity-edited HSQC using PEP and adiabatic inversion and refocusing pulses with gradients in back-inept (**hsqcedetgpsisp2.2**)

Phase-sensitive ge-2D multiplicity-edited HSQC using PEP and inversion, refocusing and matched sweep adiabatic pulses with gradients in back-inept (**hsqcedetgpsisp2.3**)

Gradient-enhanced form f3 channel

Phase-sensitive ge-2D ^1H - ^{15}N HSQC-edited using PEP (**hsqcedetf3gpsi**)

Phase-sensitive ge-2D ^1H - ^{15}N HSQC-edited using PEP with gradients in back-inept (**hsqcedetf3gpsi2**)

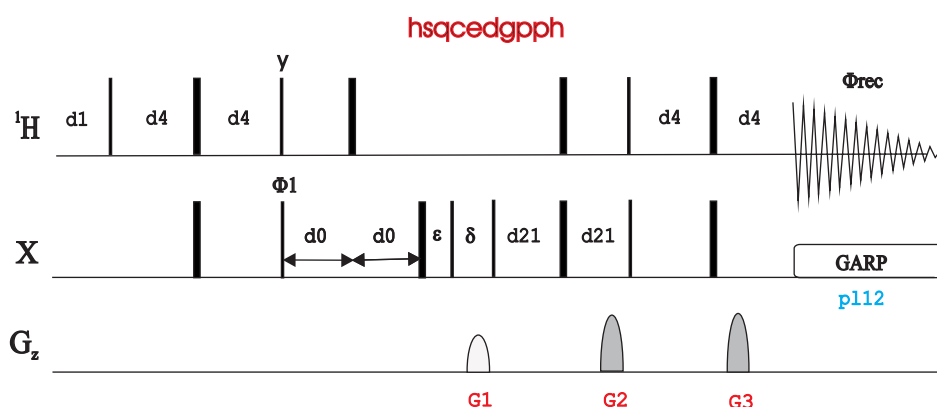

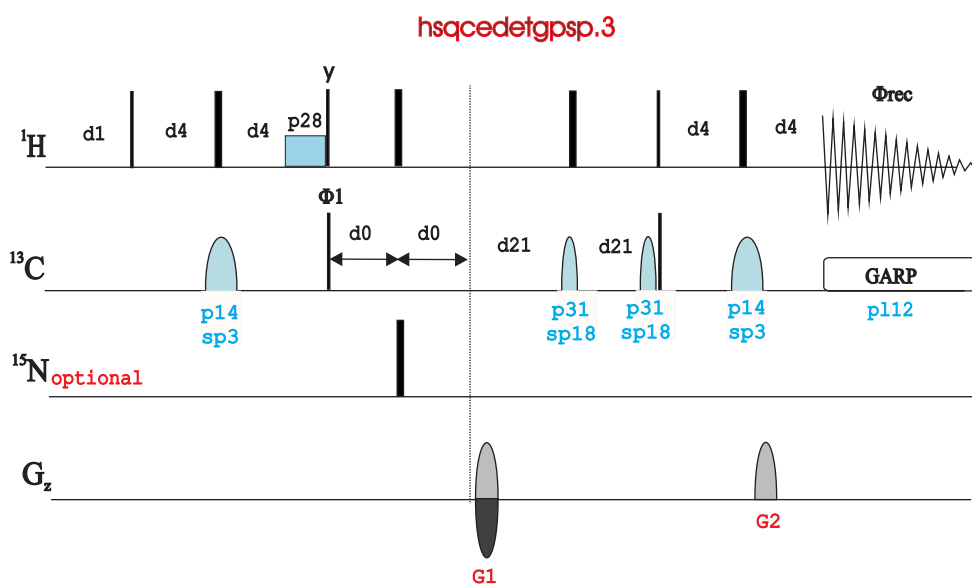
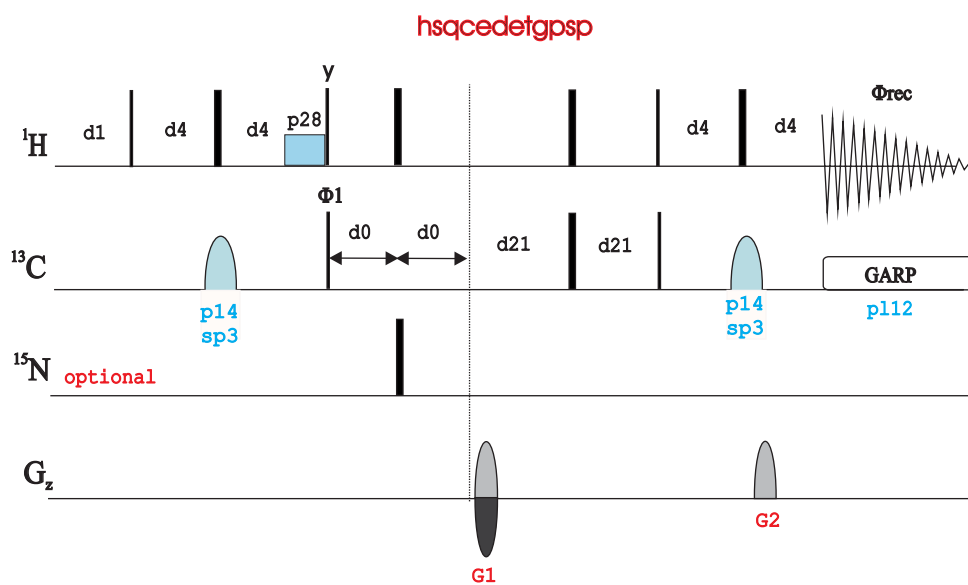
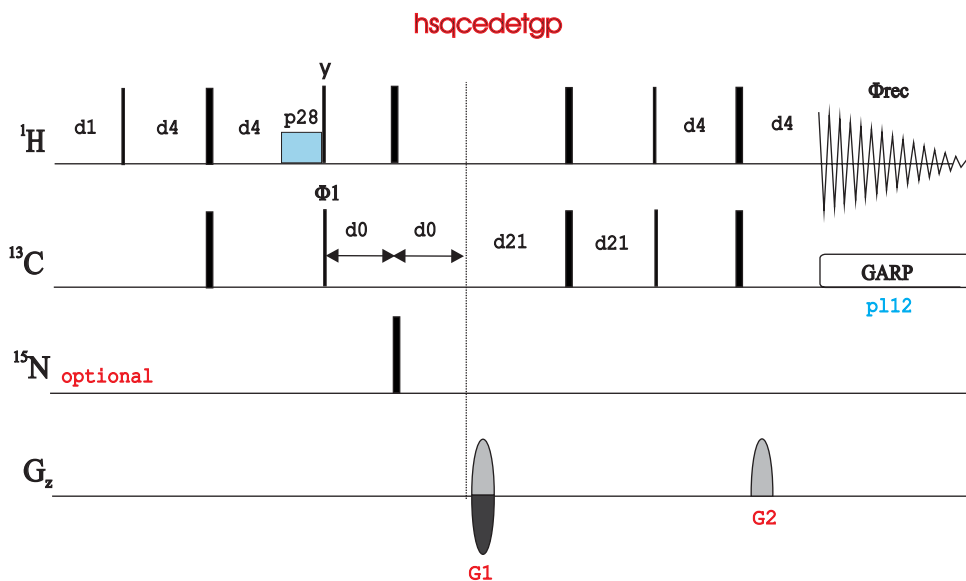

hsqcedetgpsisp

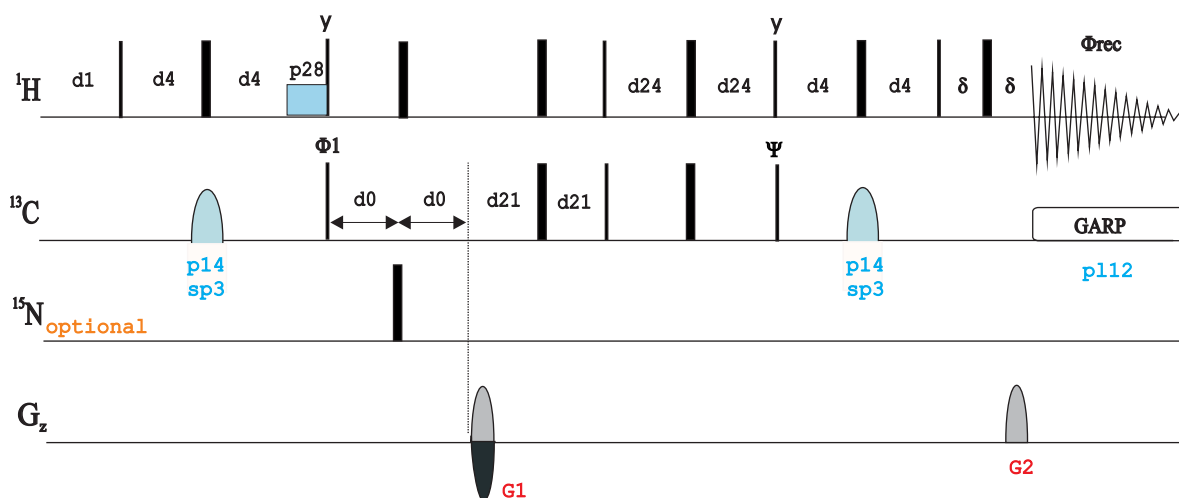

hsqcedetgpsisp2

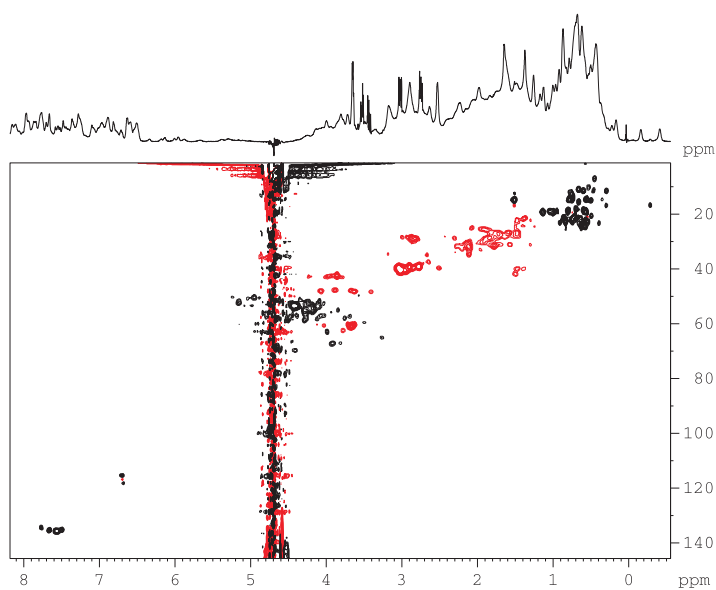
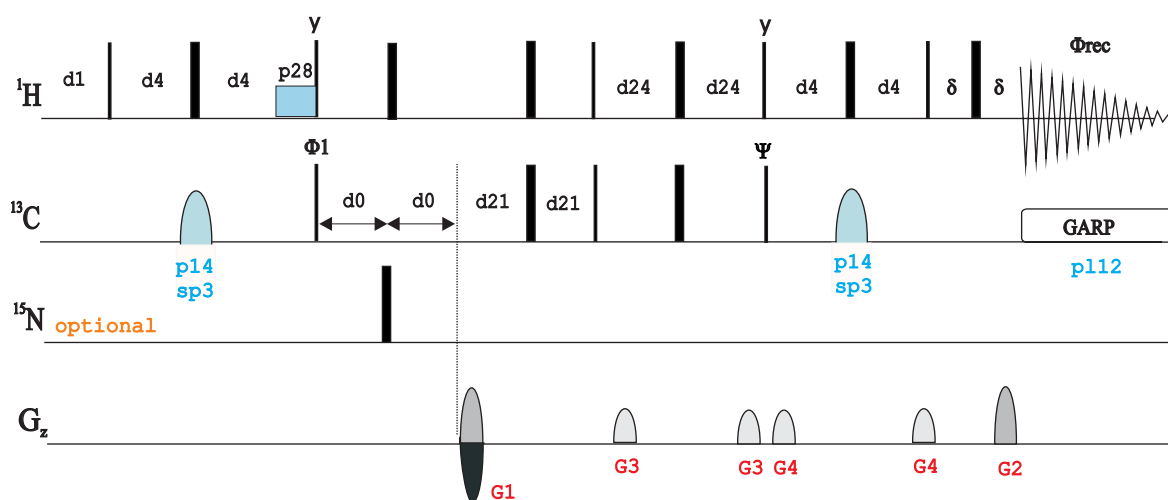

hsqcedetgpsisp.2

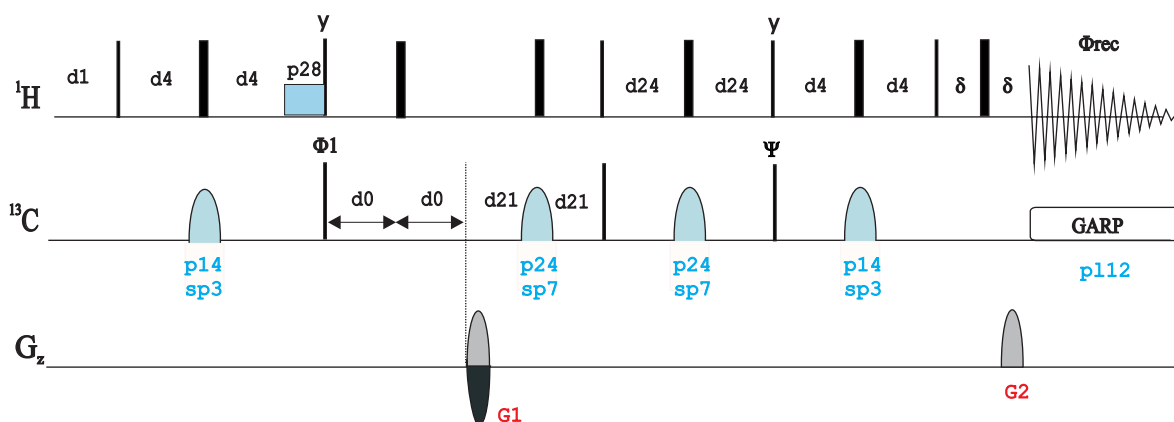

hsqcedetgpsisp2.2

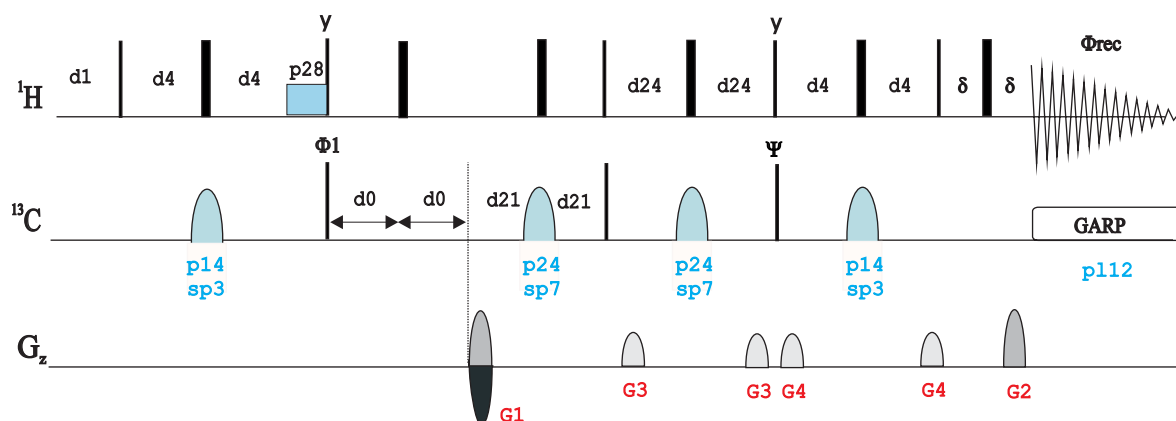

hsqcedetgpsisp2.3

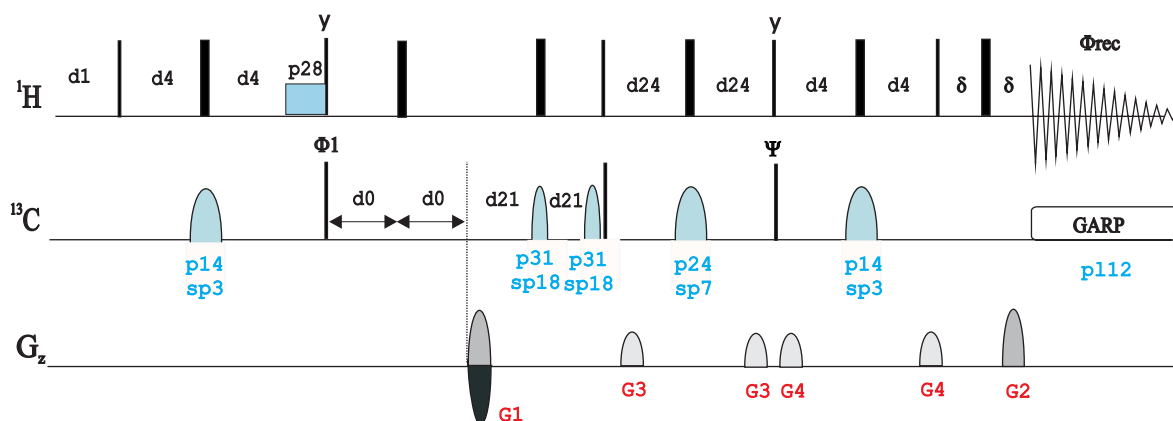

hsqcetdf3gpsl

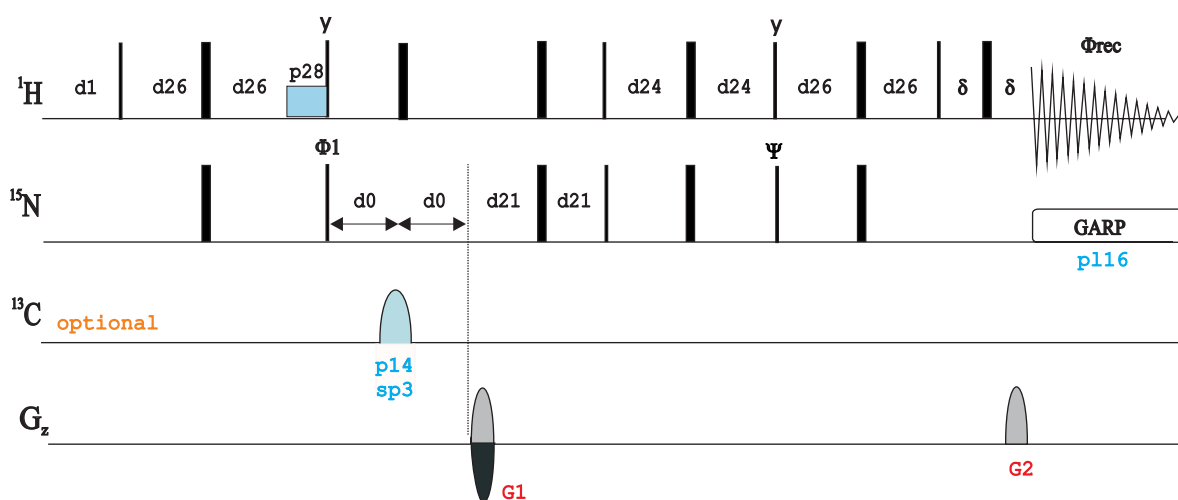

hsqcetdf3gpsl2

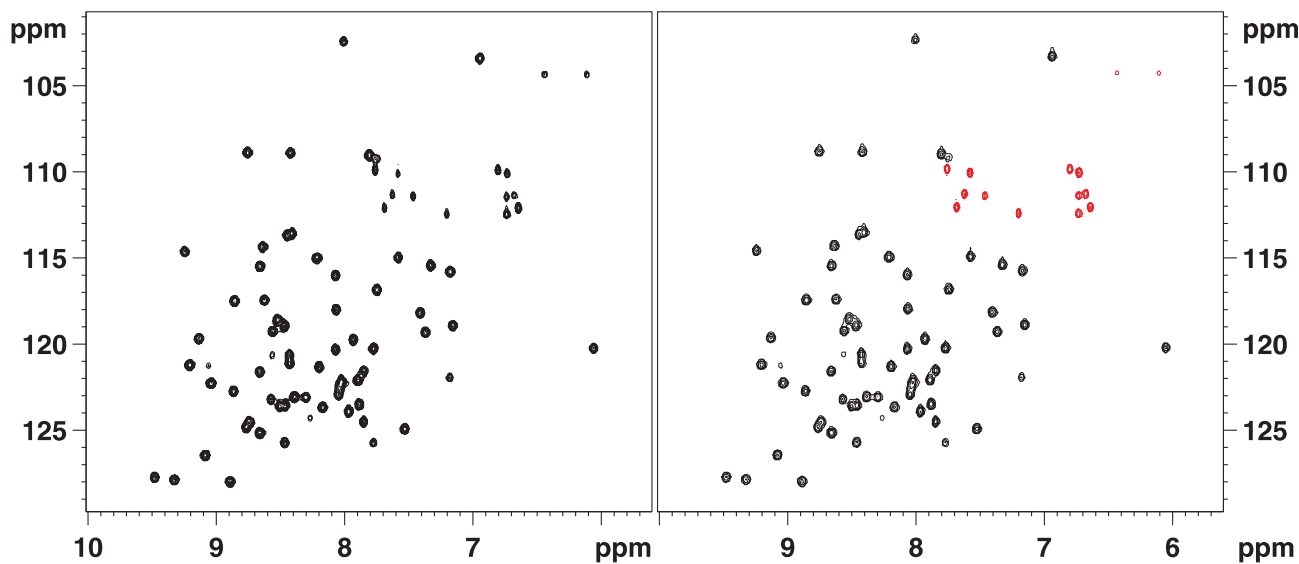
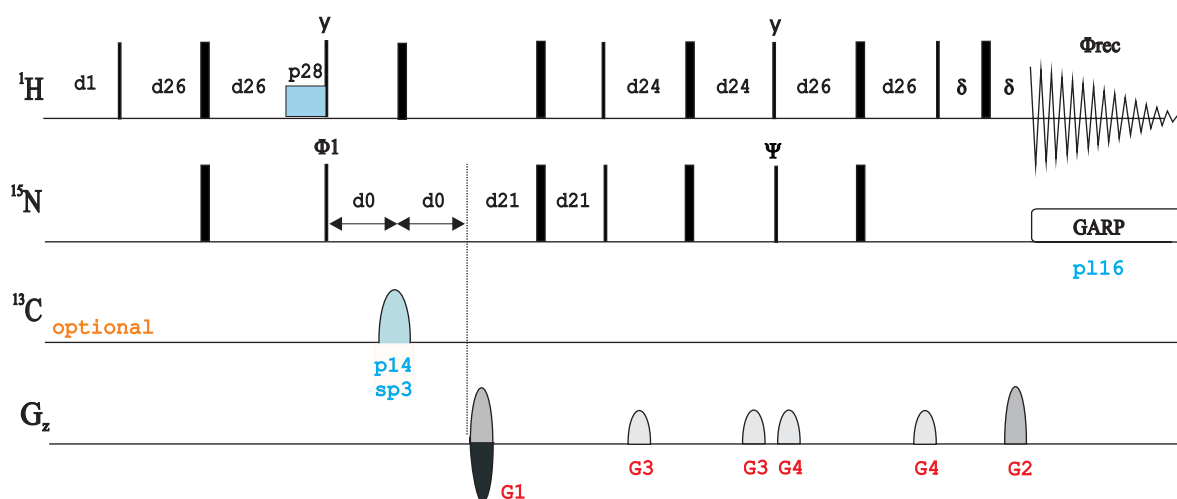

BRUKER PULSE PROGRAM CATALOGUE

NMRGuide

2D CONSTANT-TIME
HSQC AND HMQC
EXPERIMENTS

2D Constant-time Correlations

Phase-sensitive Constant-time ge-2D HSQC

- Using adiabatic pulses (**hsqcctetgppsp**)
- Using adiabatic pulses without CO refocusing (**hsqcctetgppsp.2**)
- Using adiabatic pulses and PEP (**hsqcctetgppspis**)

Phase-sensitive Constant-time ge-2D HMQC

- Using adiabatic pulses (**hmqcctetgpp**)
- For correlating CH₂ groups (**hsqcctetgpp.2**)

Also see **hsqcctetgppjc** and **hsqcctetgppjclr**

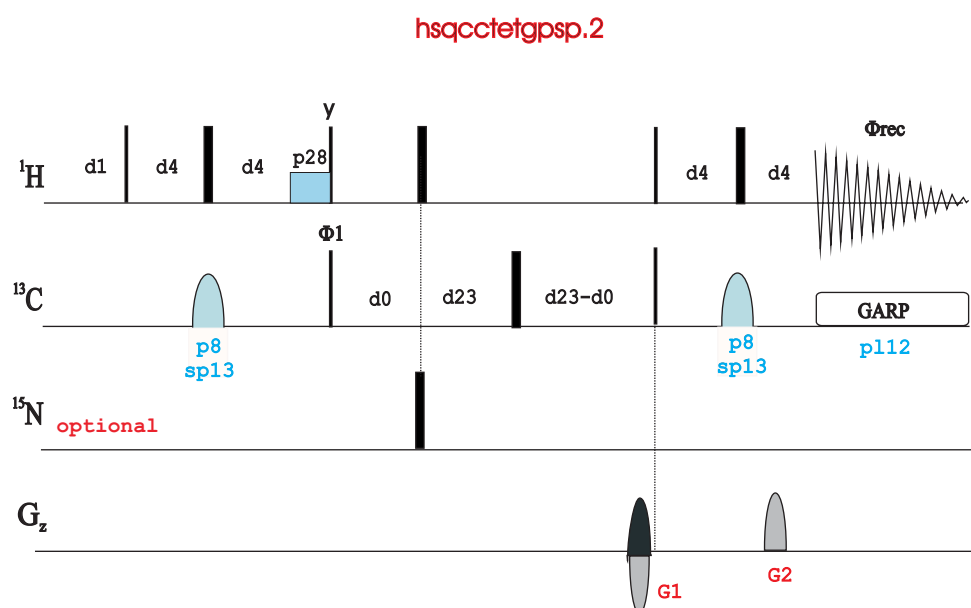
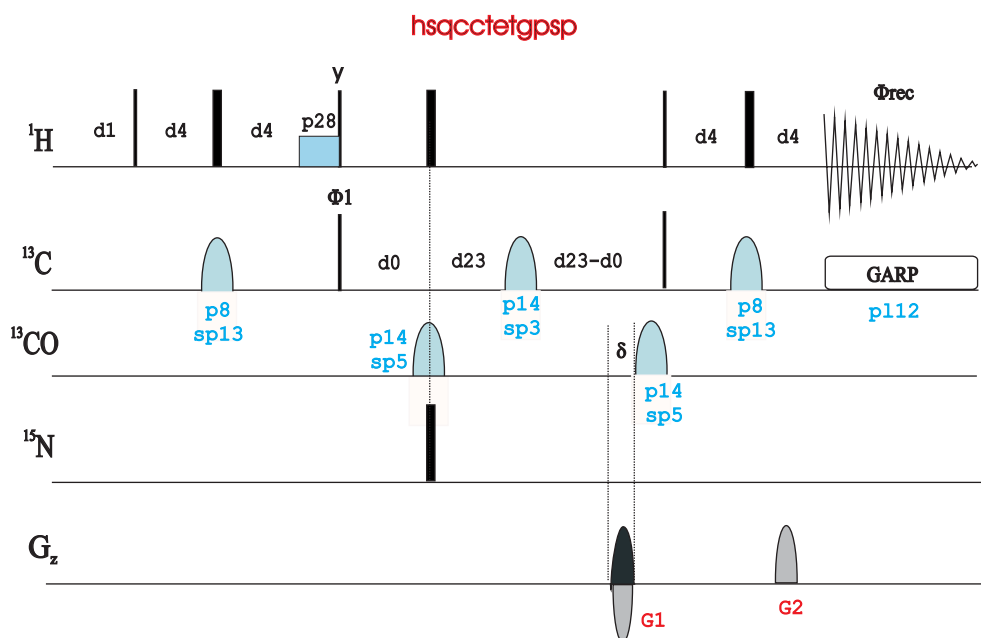

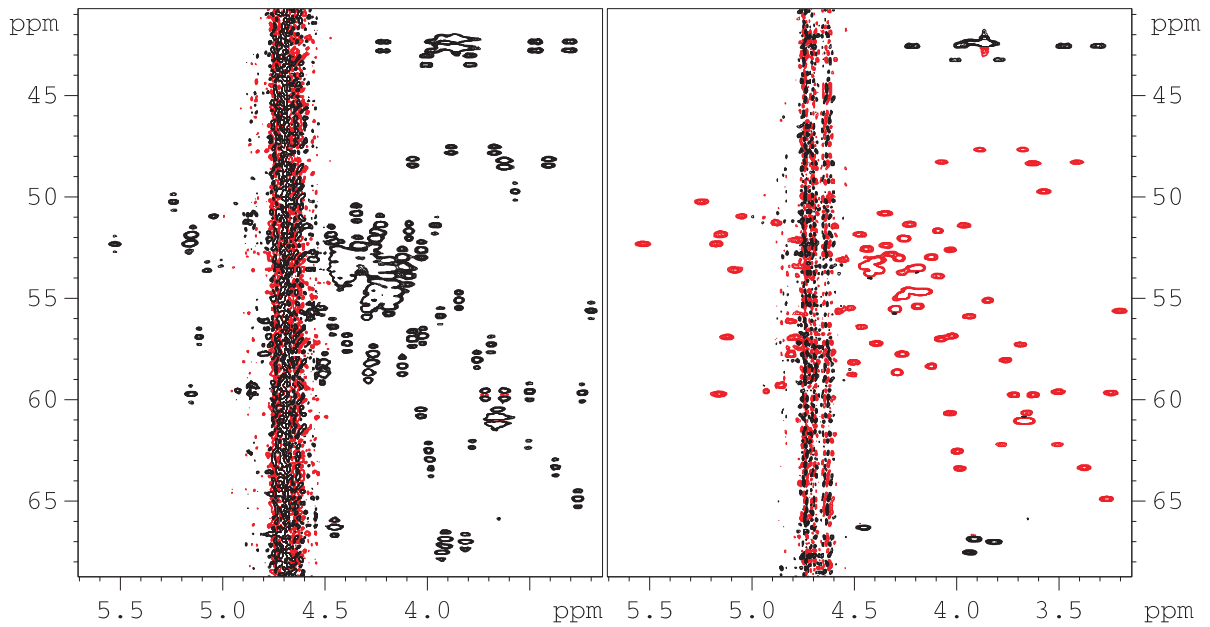
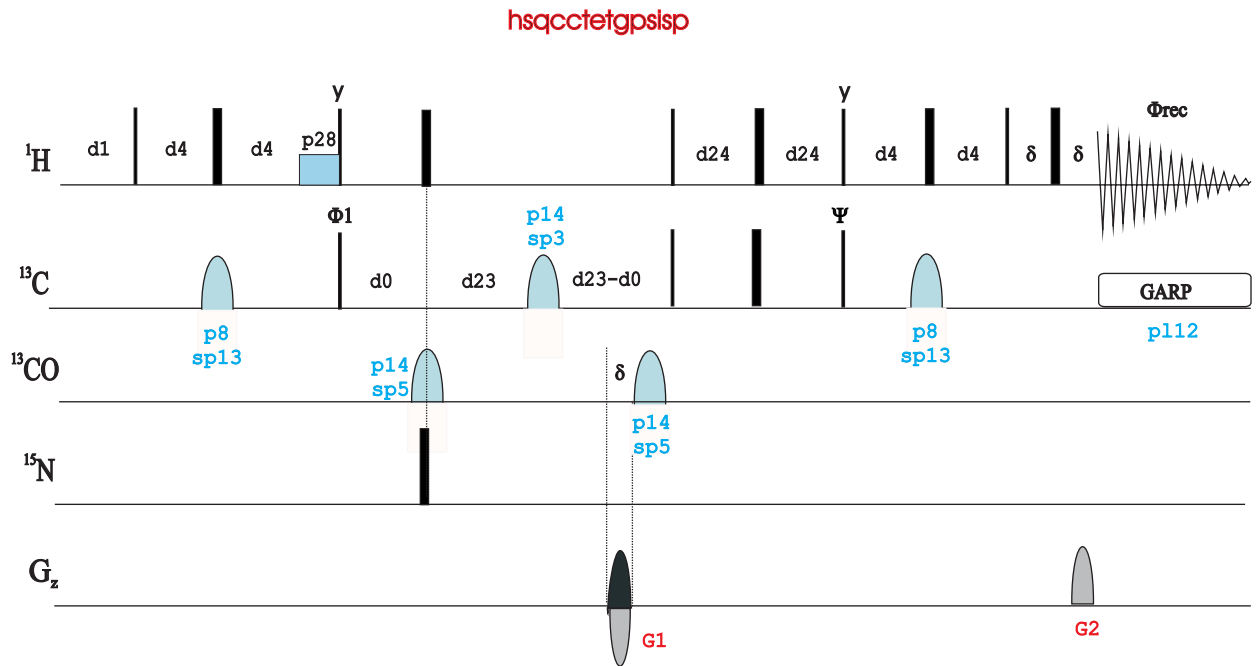

hmqcctetgp

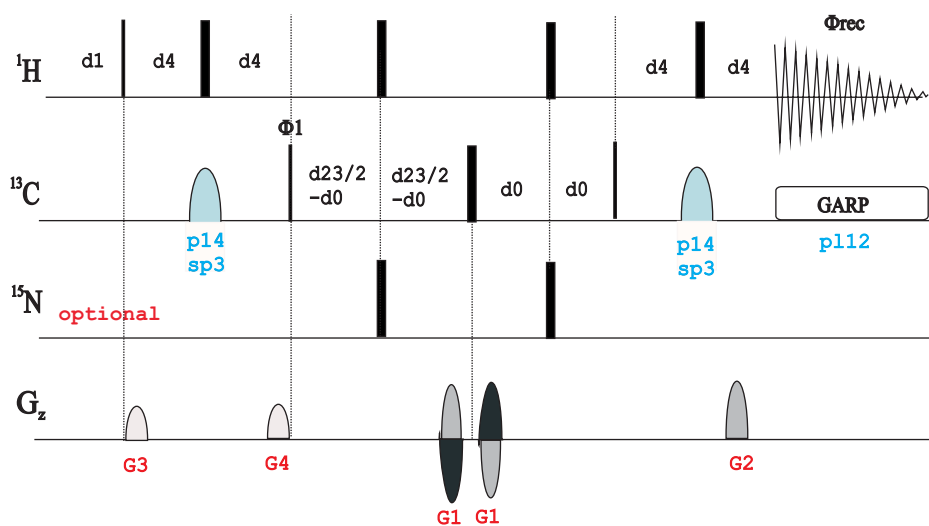

hmqcctetgp.2

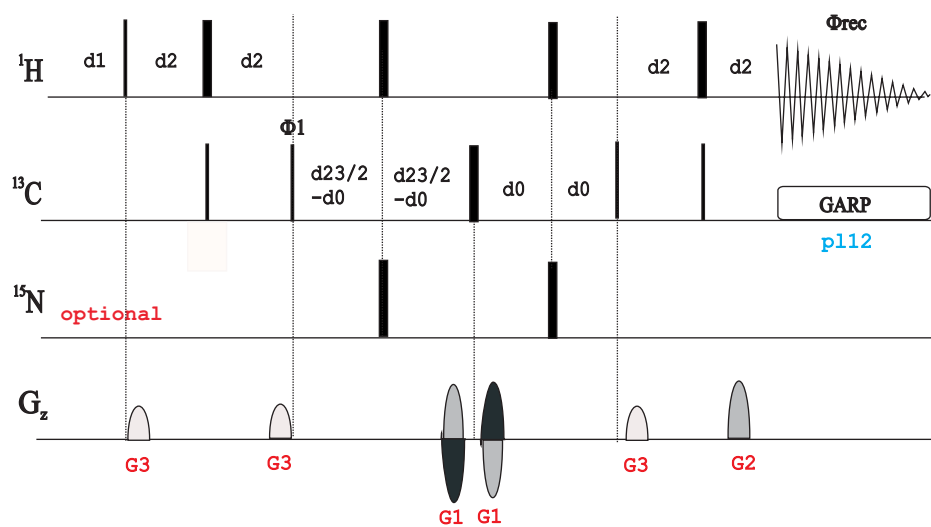

BRUKER PULSE PROGRAM CATALOGUE

NMRGuide

2D INVERSE-INEPT
EXPERIMENT

Phase-sensitive ge-2D Inverse INEPT using echo-antiecho (**xhcoetgp**)

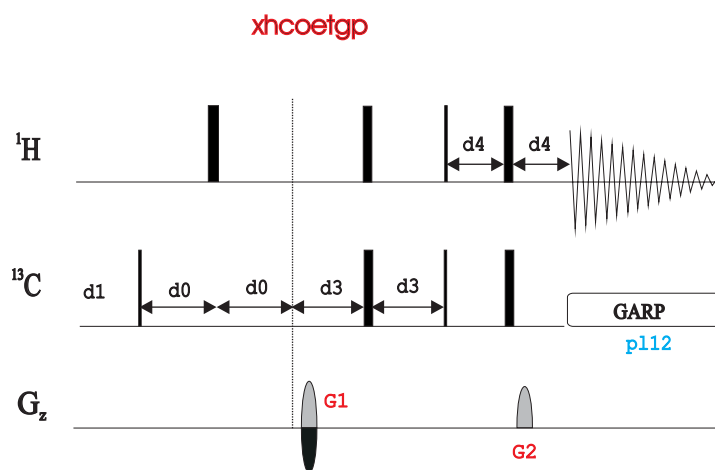

BRUKER PULSE PROGRAM CATALOGUE

NMRGuide

2D SPIN-EDITED
HSQC EXPERIMENTS

One-bond ^1H - ^{15}N Couplings

- ge-2D ^1H - ^{15}N α,β -HSQC (**hsqcetf3gpss**)
 - ge-2D ^1H - ^{15}N HSQC-IPAP using watergate (**hsqcf3gpiaphwg**)
 - ge-2D ^1H - ^{15}N HSQC-IPAP using watergate and sensitivity improvement (**hsqcf3gpiaphsiwg**)

One-bond ^1H - ^{13}C Couplings

- 2D H-1/C-13 CT-HSQC (**hsqcetctgpjc**)

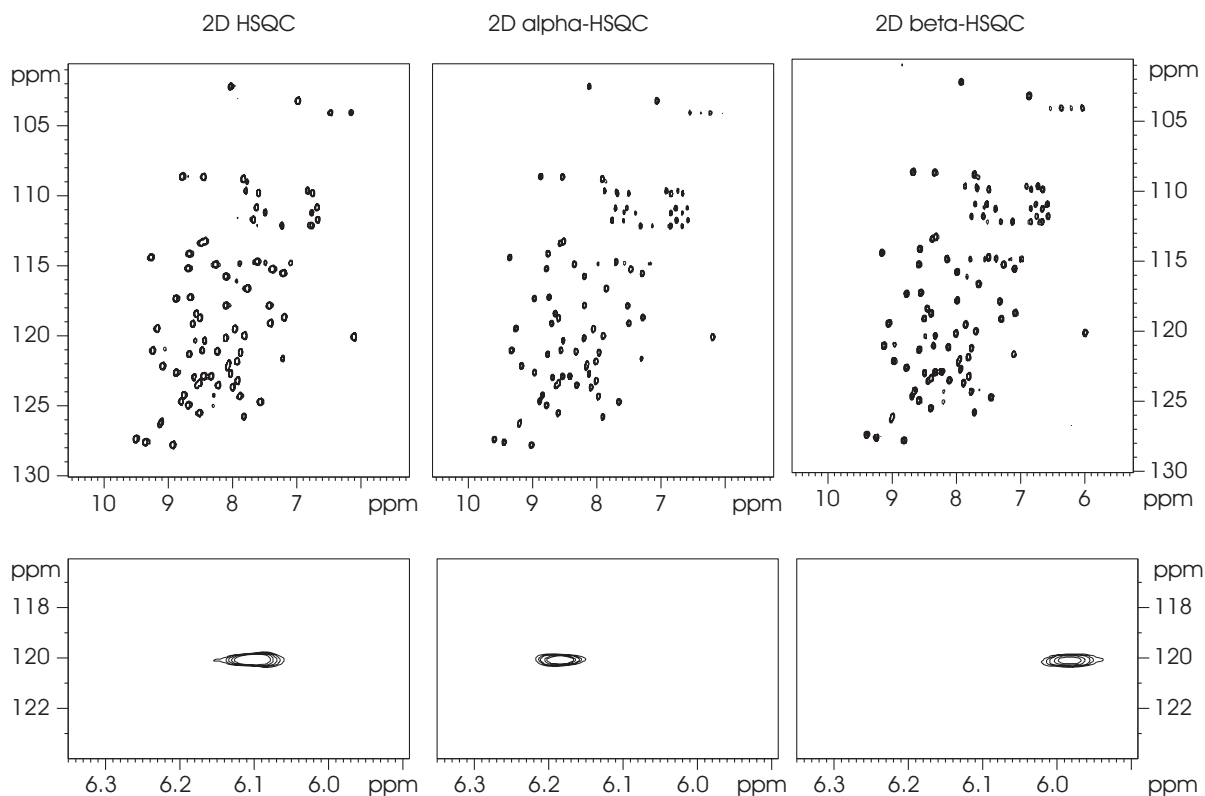
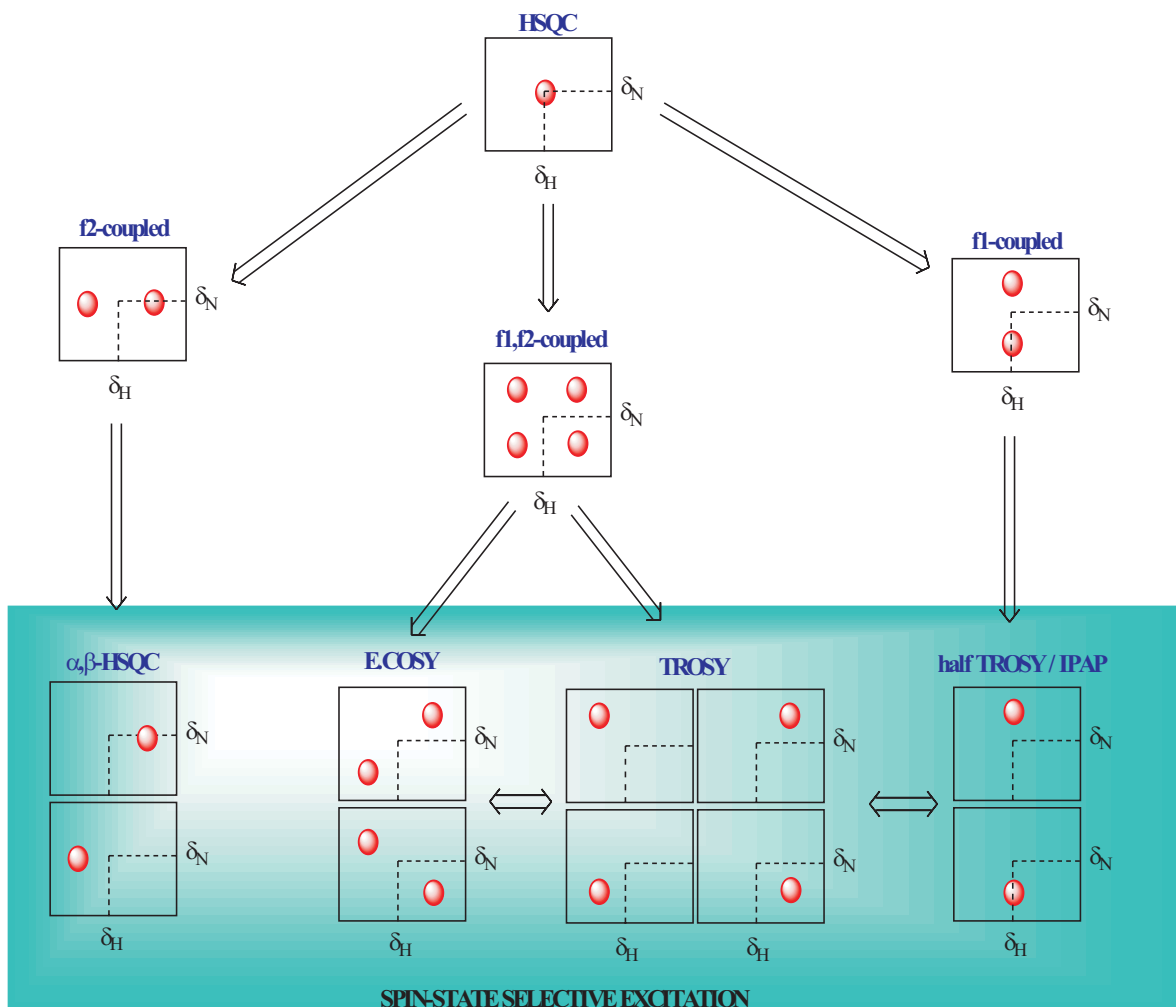

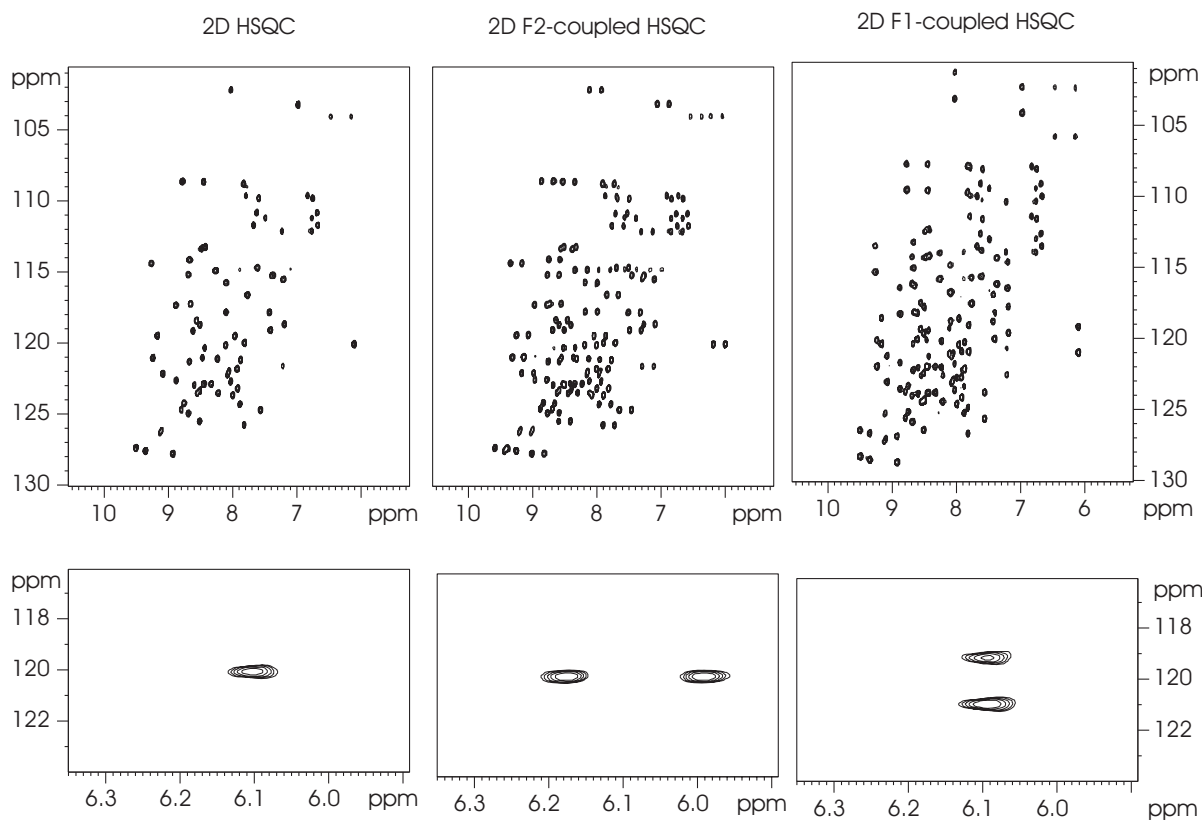
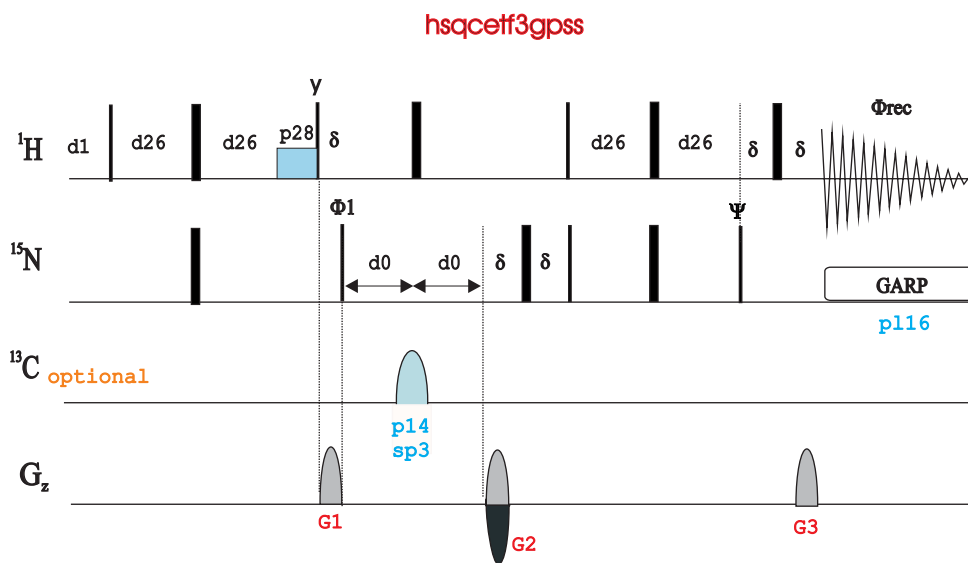

hsqcf3gpiaphsiwg

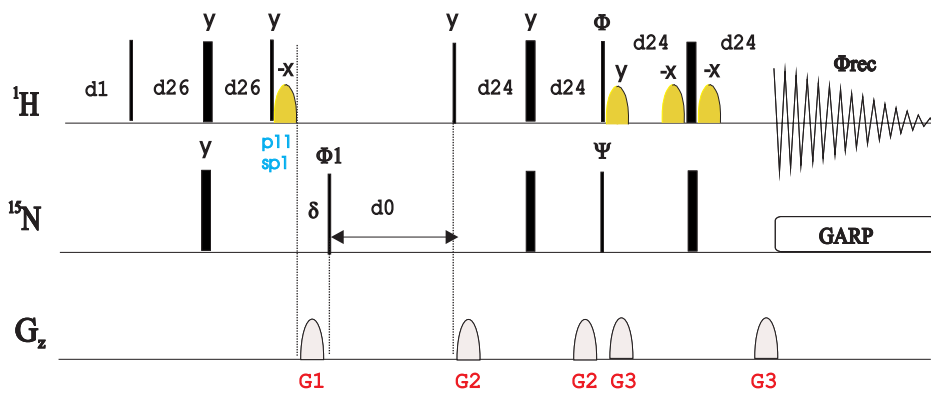

hsqcf3gpiaphwg

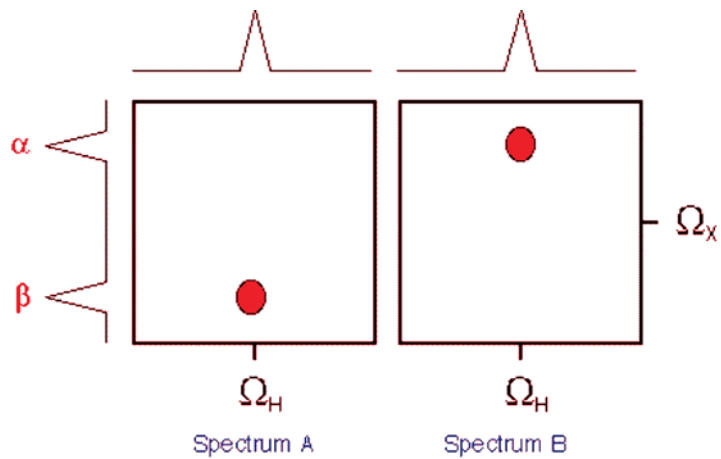
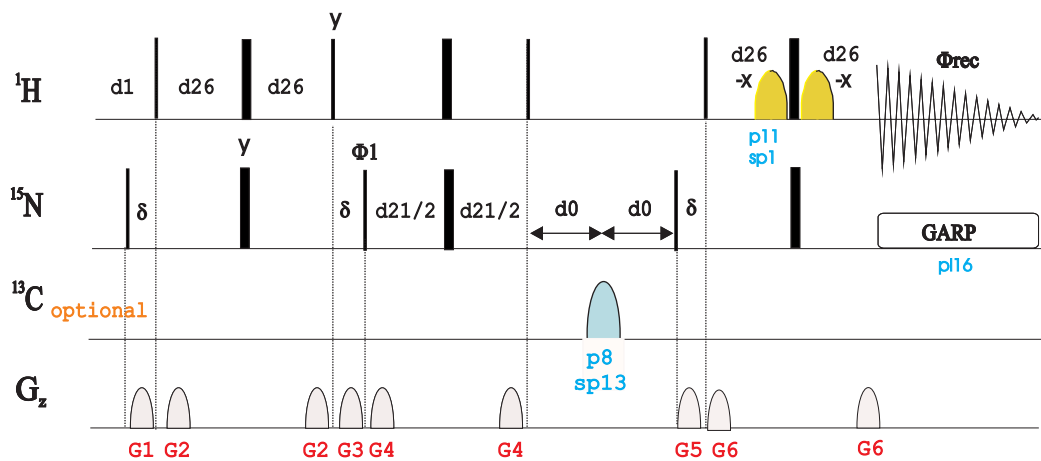

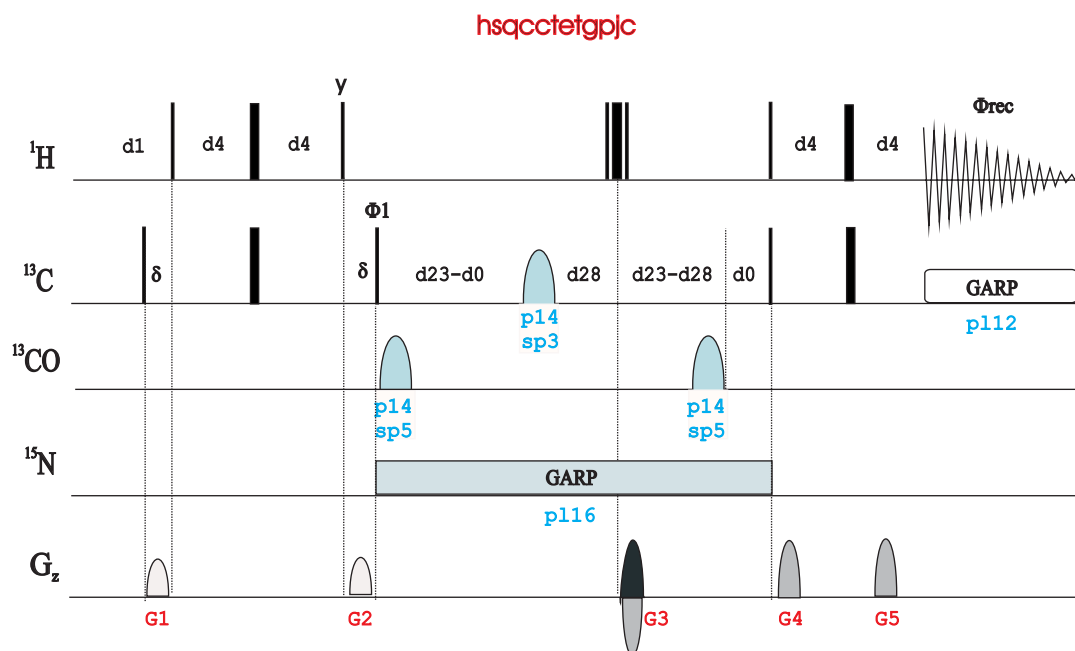

BRUKER PULSE PROGRAM CATALOGUE

NMRGuide

2D TROSY EXPERIMENTS

2D TROSY Experiments

From f2 channel:

Phase-sensitive ge-2D TROSY with presaturation (**trosygpphpr**)
 ge-2D TROSY for aromatic residues with WATERGATE (**trosyargpphgw**)

From f3 channel:

Phase-sensitive ge-2D ^1H - ^{15}N TROSY

- Using echo-antiecho (**trosyetf3gpsi** | TROSYETF3GPSI)
- Using echo-antiecho and different phase cycling (**trosyetf3gpsi2**)
- Using echo-antiecho and different phase cycling to give IPAP TROSY (**trosyetf3gpiasi**)
- Using WATERGATE (3-9-19) (**trosyf3gpph19** | TROSYF3GPPH19)
- Using WATERGATE and improved sensitivity (**trosyf3gpphsi19** | TROSYF3GPPHSI19)

Phase-sensitive ge-2D ^1H - ^{15}N ZQ-TROSY using WATERGATE (**trosyzqpphgw**)

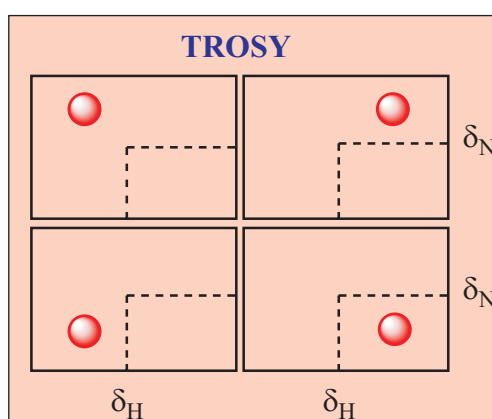
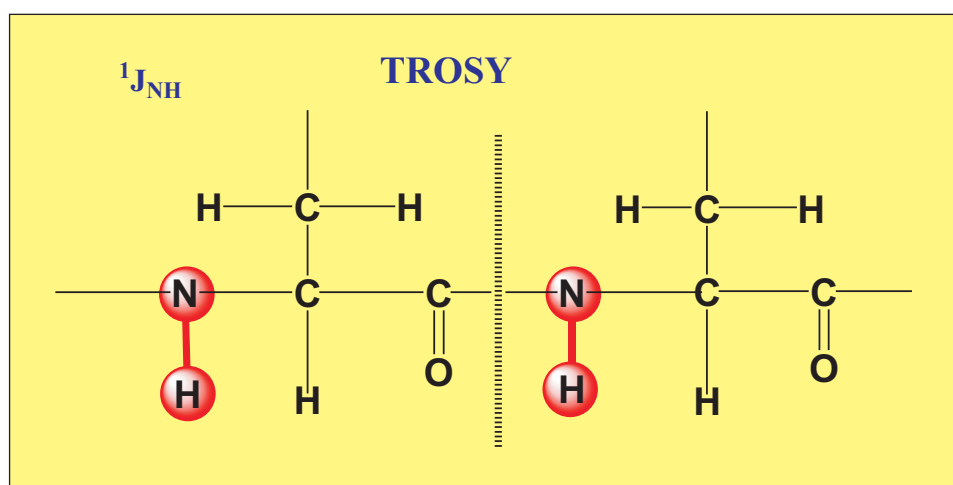

trocyf3gppl19

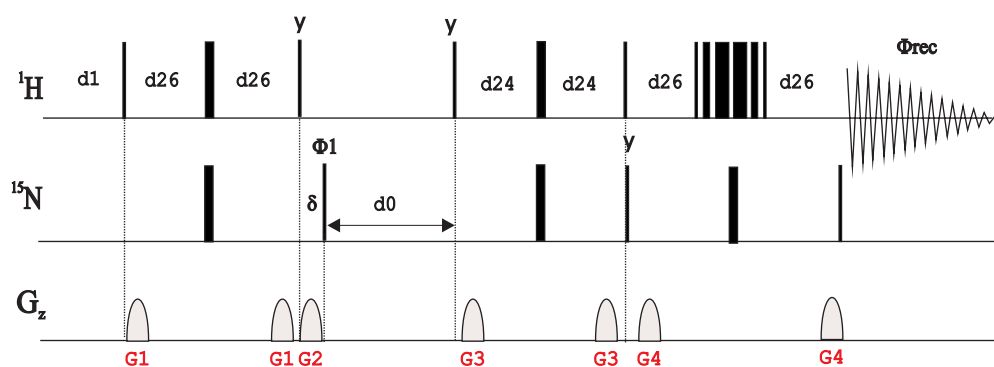

trocyf3gppl19

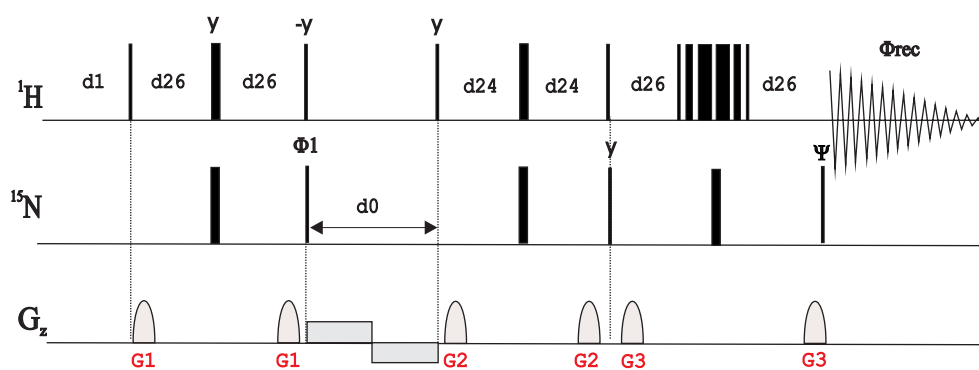

trocyf3gppl19.2

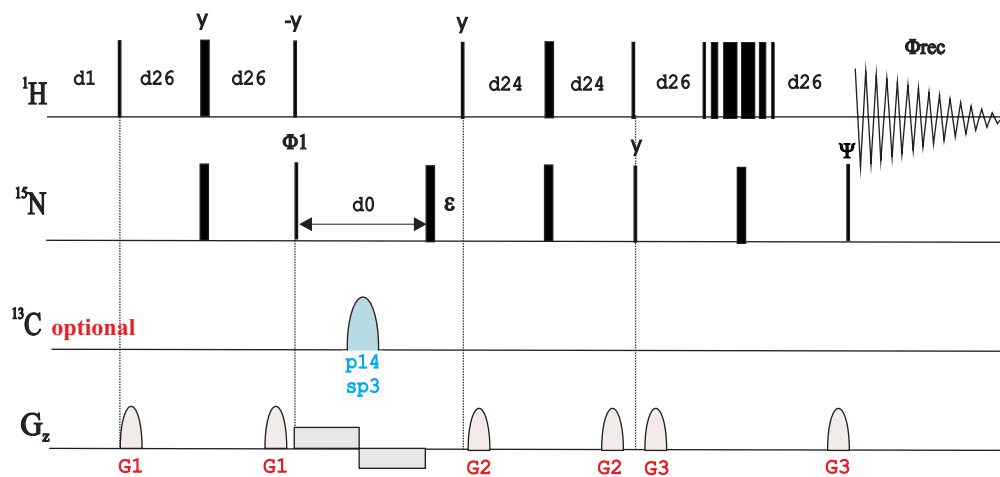

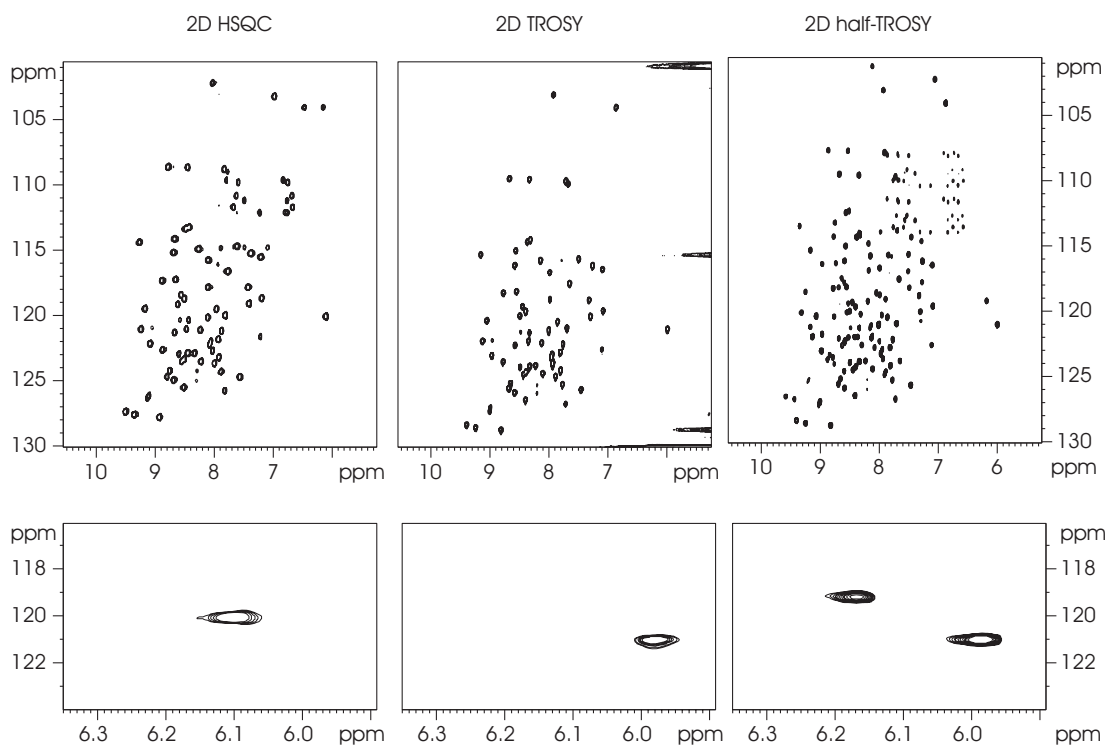
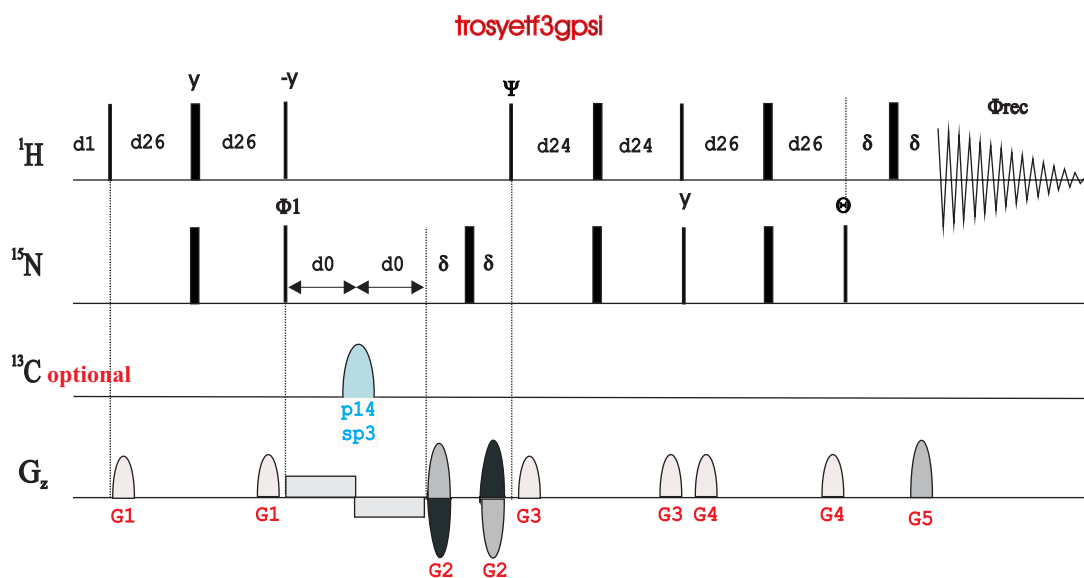

trosetf3gpsi2

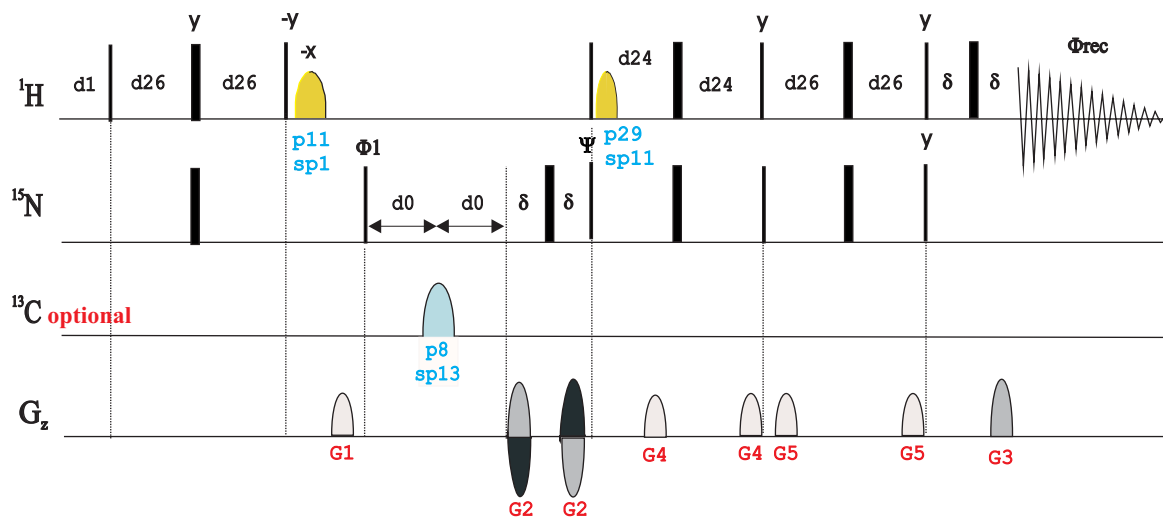

trosetf3gpsi1

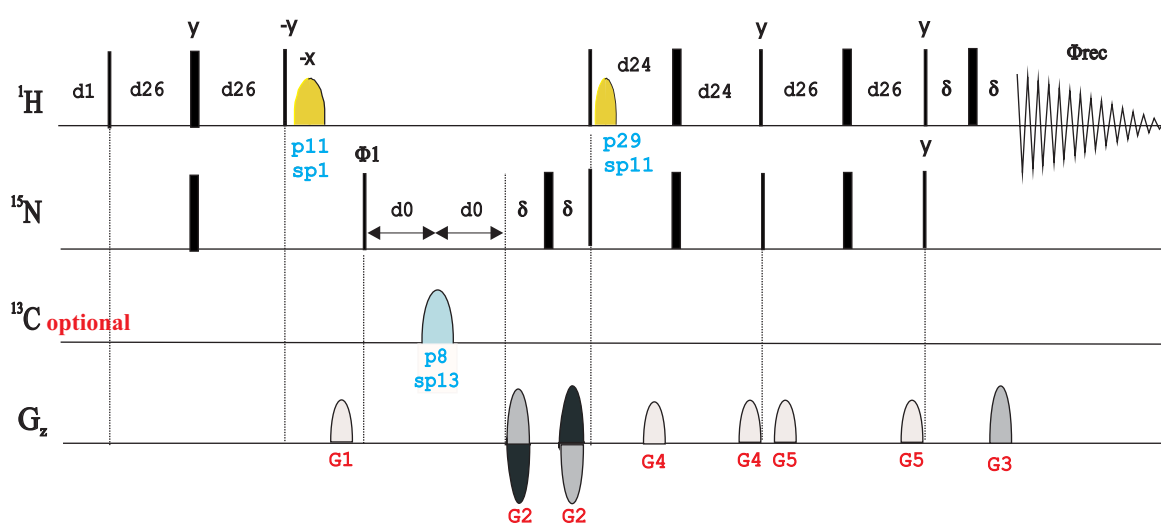

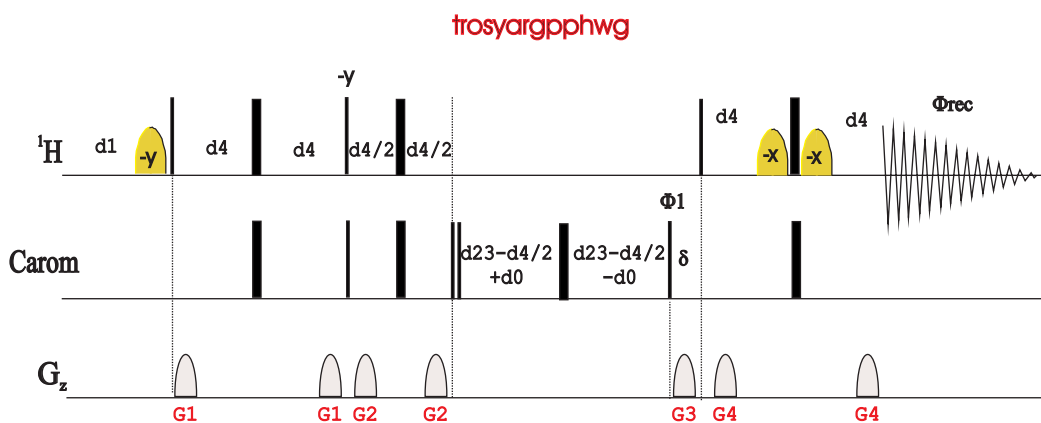
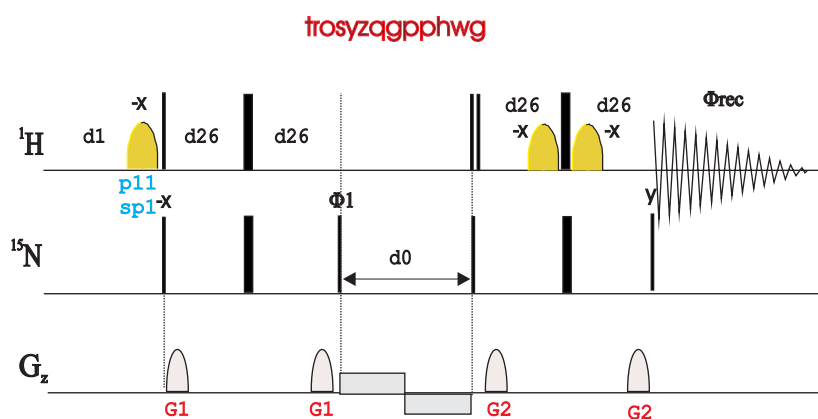
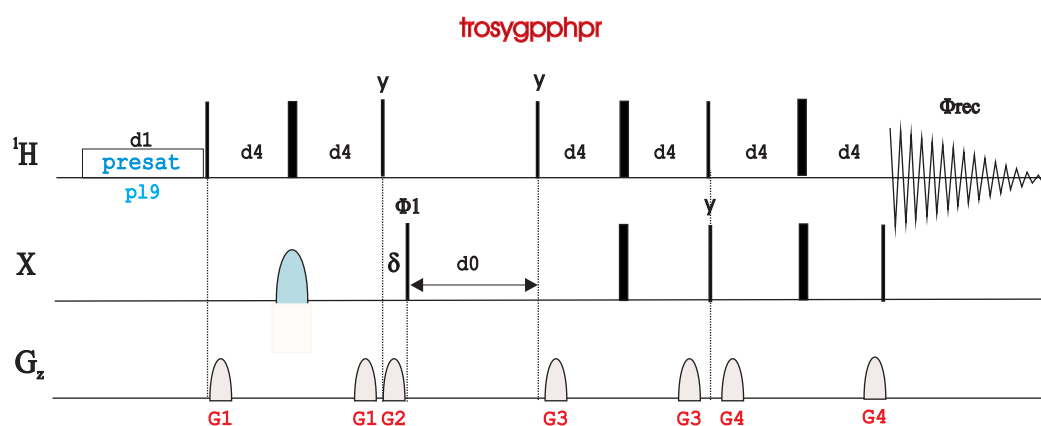

BRUKER PULSE PROGRAM CATALOGUE

NMRGuide

2D CRINEPT EXPERIMENT

ge-2D ^1H - ^{15}N CRINEPT using flip-back (**crineptgpph**)

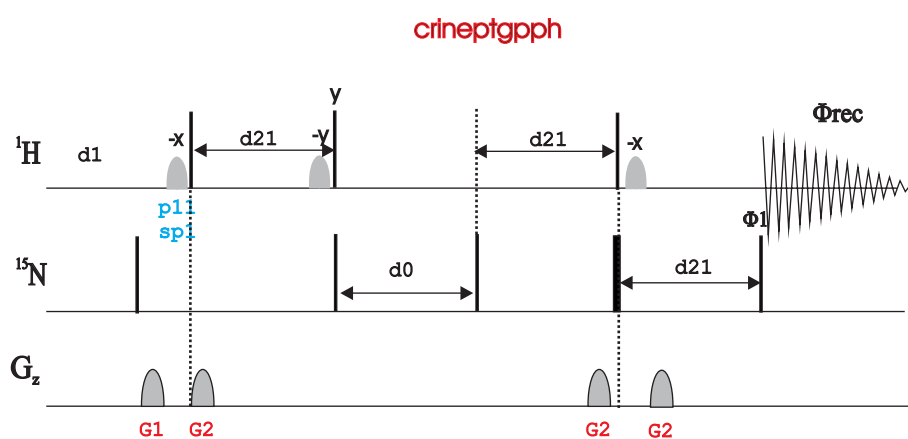

BRUKER PULSE PROGRAM CATALOGUE

NMRGuide

2D HMQC-COSY EXPERIMENTS

2D HMQC-COSY Experiments

Phase cycled:

Magnitude-mode 2D HMQC-COSY using BIRD (**hmqcbindqf1**)
 Phase-sensitive 2D HMQC-COSY using BIRD with decoupling (**hmqcbiph1**)
 Phase-sensitive 2D HMQC-COSY using BIRD without decoupling (**hmqcbindph1**)
 Phase-sensitive 2D HMQC-COSY-DQF using BIRD (**hmqcbidph1**)

Gradient-enhanced:

Magnitude-mode ge-2D HMQC-COSY (**hmqcgpqf1**)
 H2BC experiment with a three-low-pass filter (**h2bcetgp13**)

Also see HMQC and HMQC-TOCSY experiments

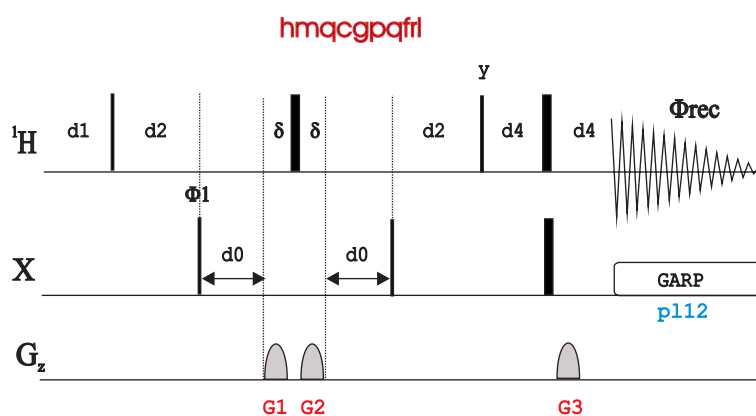
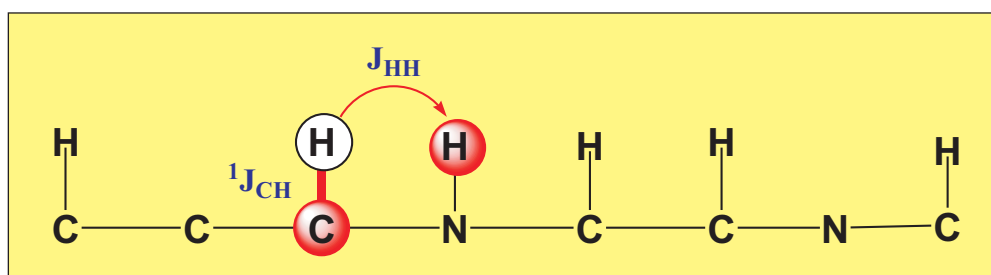

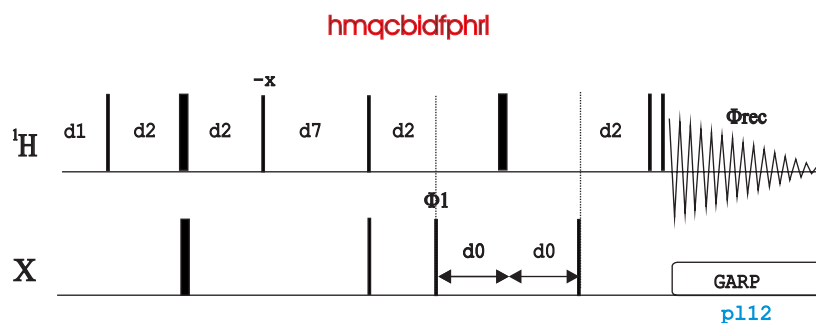
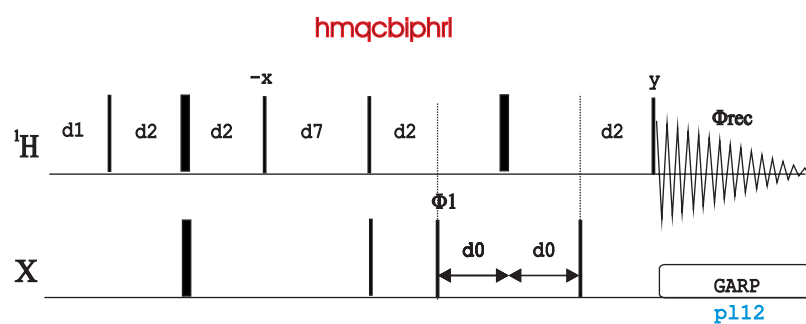
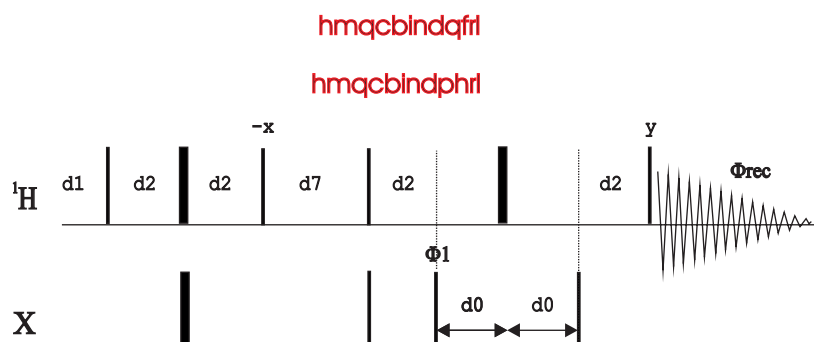

h2bcetgp13

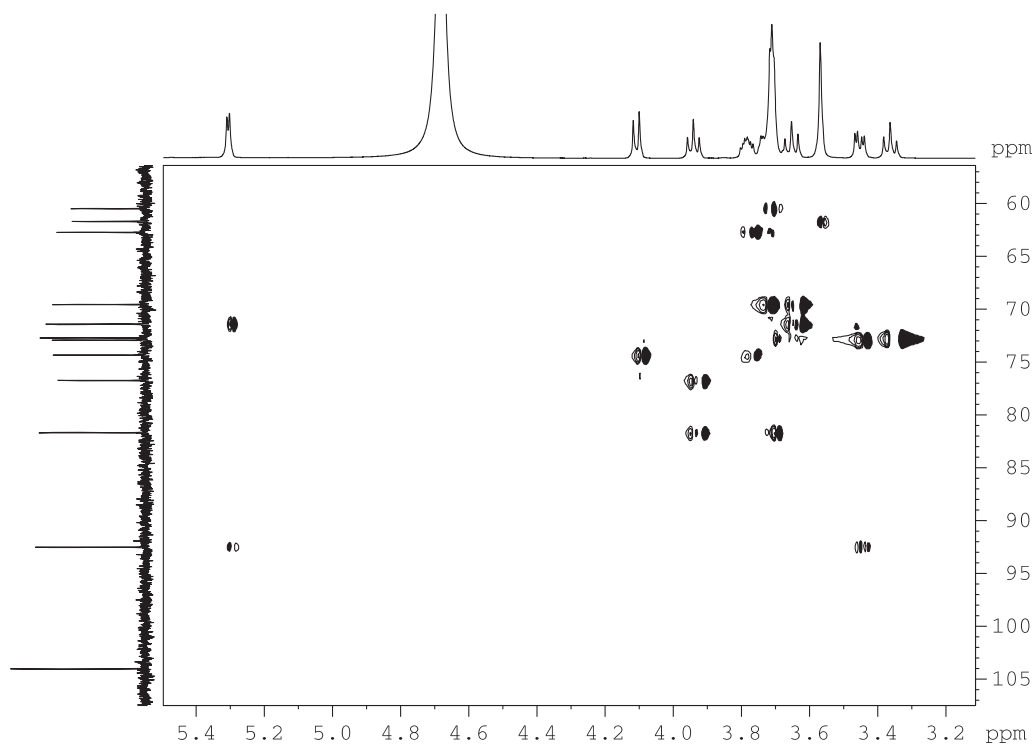
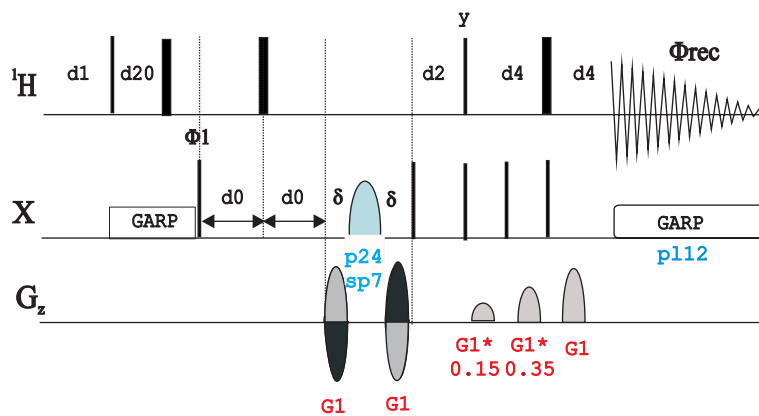

BRUKER PULSE PROGRAM CATALOGUE

NMRGuide

2D HMQC-TOCSY EXPERIMENTS

- **Phase-cycled:**

Phase-sensitive 2D HMQC-TOCSY (**hmqcmlph**)
Phase-sensitive 2D HMQC-TOCSY without decoupling (**hmqcmlndph**)
Magnitude-mode 2D HMQC-TOCSY using BIRD (**hmqcbimlqf**)
Magnitude-mode 2D HMQC-TOCSY using BIRD without decoupling (**hmqcbimlndqf**)

Phase-sensitive 2D HMQC-TOCSY using BIRD (**hmqcbimlph**)
Phase-sensitive 2D HMQC-TOCSY using BIRD without decoupling (**hmqcbimlndph**)

- **Phase-cycled and solvent suppression:**

Phase-sensitive 2D HMQC-TOCSY with presaturation (**hmqcmlphpr**)
Phase-sensitive 2D HMQC-TOCSY with presaturation and without decoupling (**hmqcmlndphpr**)

- **Gradient-enhanced from f2 channel:**

Magnitude-mode ge-2D HMQC-TOCSY with MLEV (**hmqcgpmlqf** | **HMQCGPML**)
Phase-sensitive ge-2D HMQC-TOCSY with DIPSI-2 using echo-antiecho (**hmqcdietgp**)
Phase-sensitive ge-2D HMQC-TOCSY with DIPSI-2 using PEP (**hmqcdietgpsi**)
Phase-sensitive ge-2D HMQC-TOCSY with DIPSI-2 using PEP using shorter overall timing (**hmqcdietgpsi.2**)

- **Gradient-enhanced from f3 channel:**

Phase sensitive ge-2D ^1H - ^{15}N HMQC-TOCSY with DIPSI-2 using echo-antiecho (**hmqcdietf3gp**)
Phase sensitive ge-2D ^1H - ^{15}N HMQC-TOCSY with DIPSI-2 using PEP (**hmqcdietf3gpsi**)
Phase sensitive ge-2D ^1H - ^{15}N HMQC-TOCSY with DIPSI-2 using PEP and shorter overall timing (**hmqcdietf3gpsi.2**)

hmqcmlndph

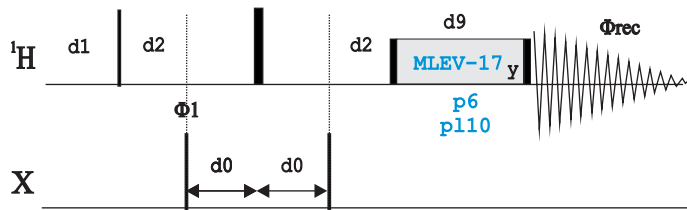

hmqcmlph

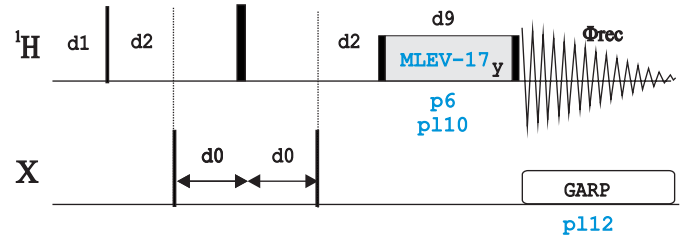

hmqcmlndphpr

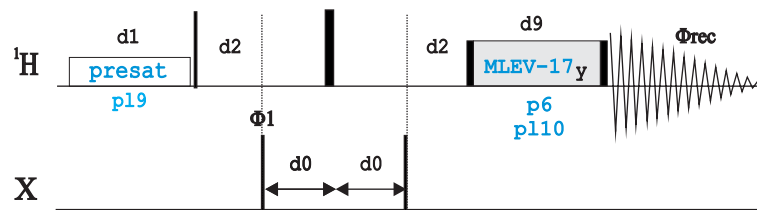

hmqcmlphpr

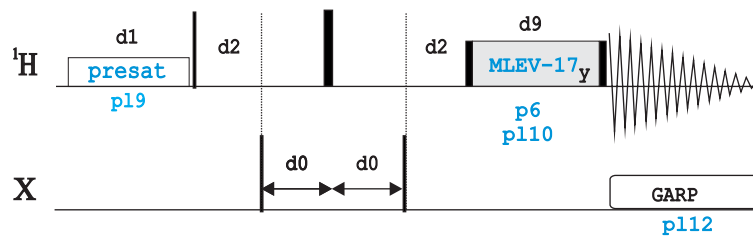

hmqcbimlqf
hmqcbimlph

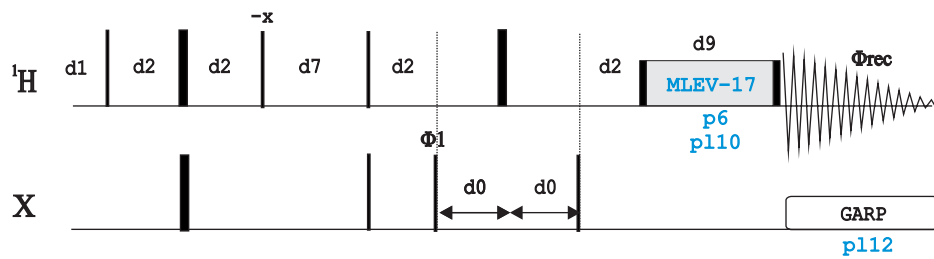

hmqcbimlndqf
hmqcbimlndph

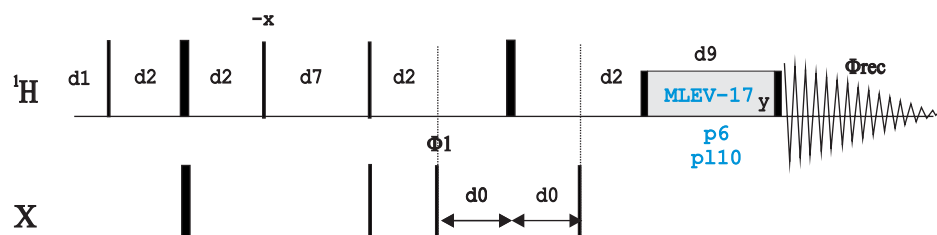

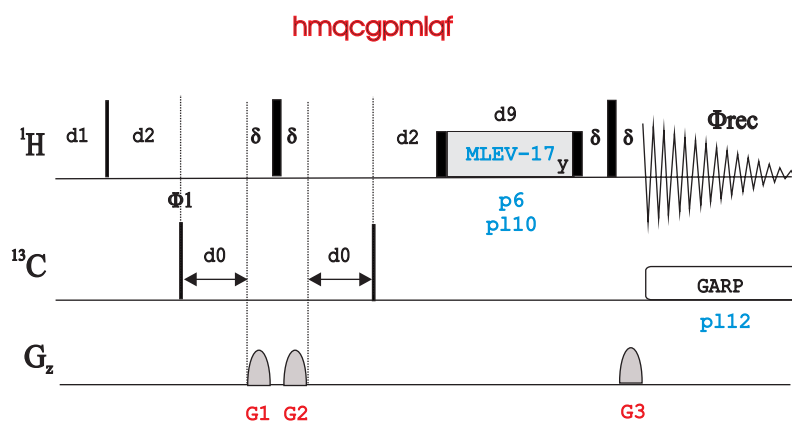
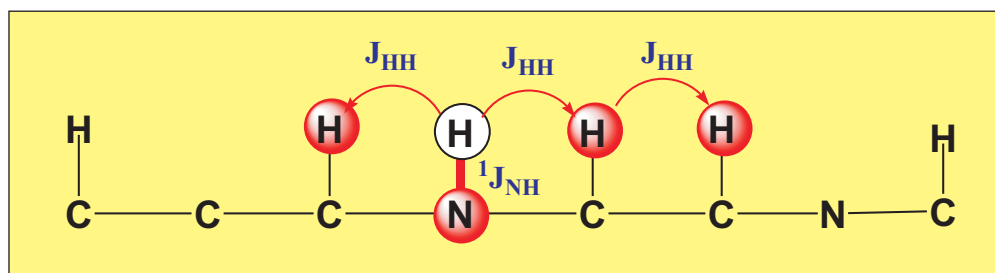
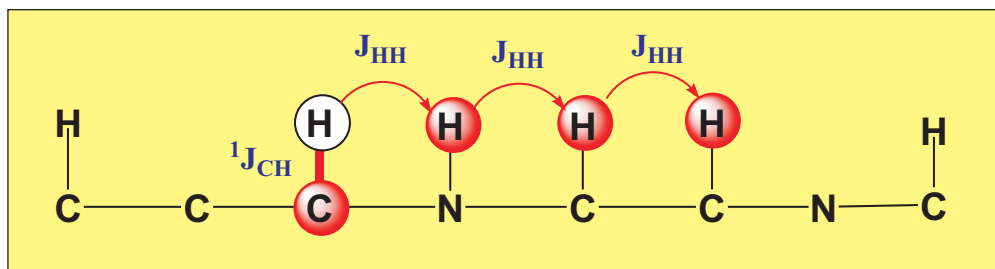

hmqcdletgp

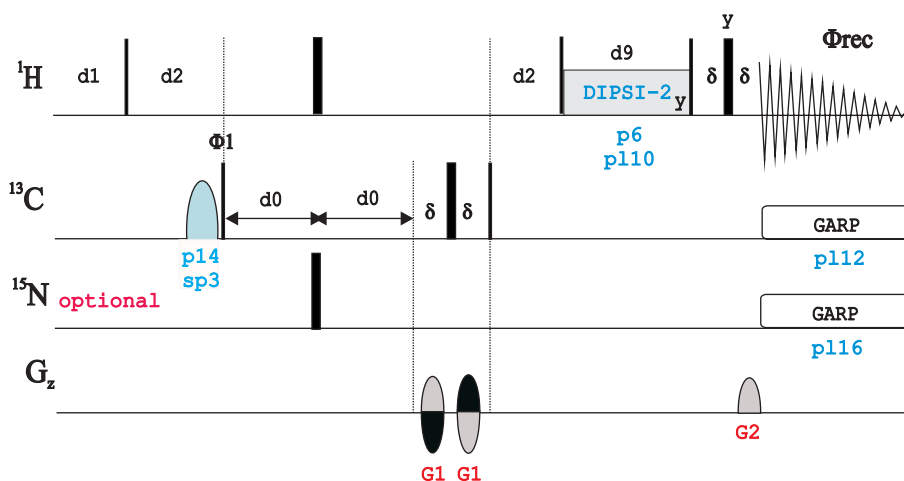

hmqcdletgpsl

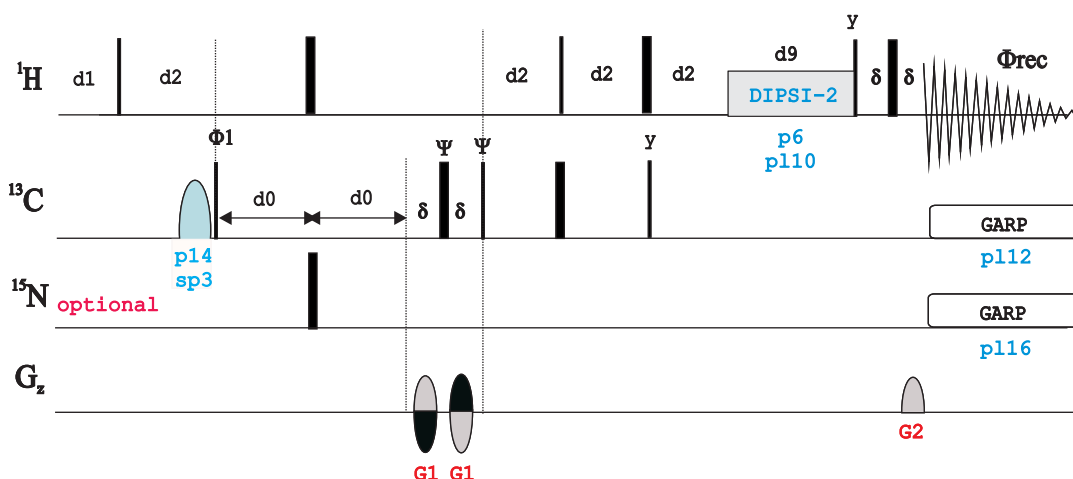

hmqcdletgpsl.2

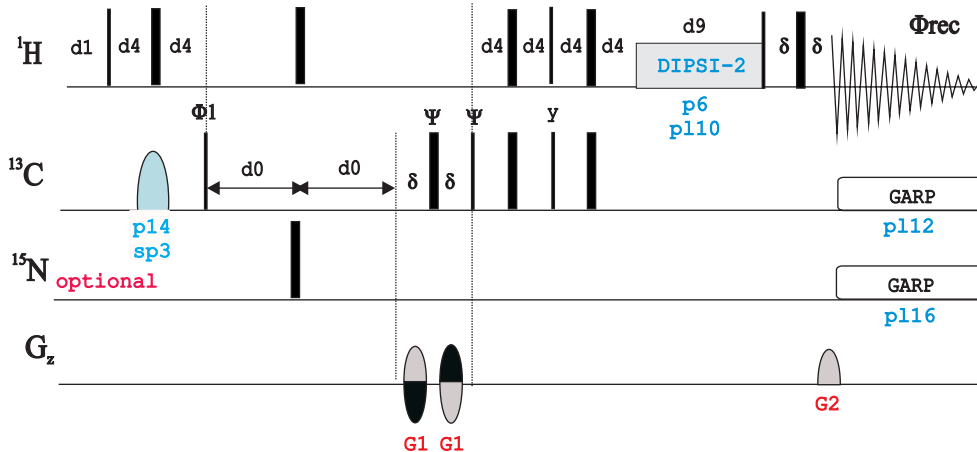

hmqcdlef3gp

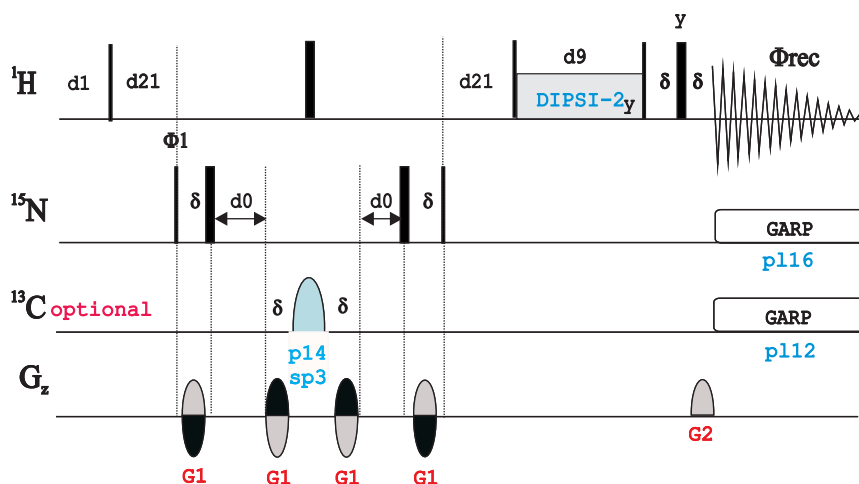

hmqcdlef3gpsl

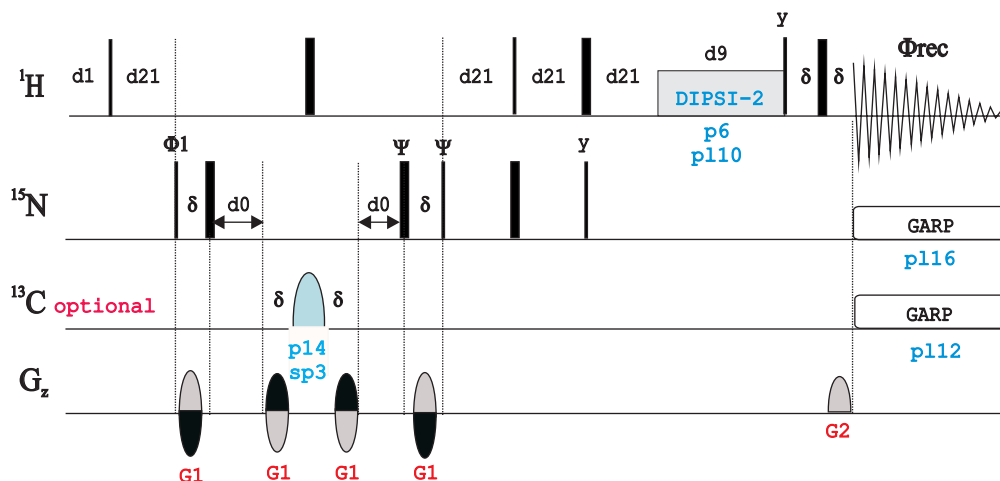

hmqcdlef3gpsl.2

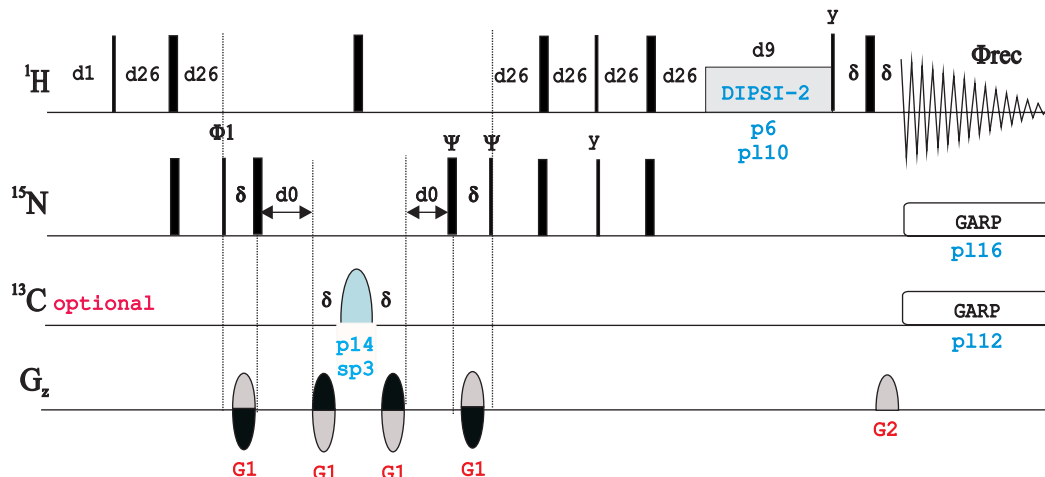

BRUKER PULSE PROGRAM CATALOGUE

NMRGuide

2D HMQC-ROESY EXPERIMENTS

- **Gradient-enhanced from the f2 channel**

Phase-sensitive ge-2D HMQC-ROESY using echo-antiecho (**hmqcetgpro**)
 Phase-sensitive ge-2D HMQC-ROESY with T-ROESY using echo-antiecho (**hmqcetgpro.2**)

- **Gradient-enhanced from the f3 channel**

Phase-sensitive ge-2D ^1H - ^{15}N HMQC-ROESY using echo-antiecho (**hmqcetf3gpro**)
 Phase-sensitive ge-2D ^1H - ^{15}N HMQC-ROESY with T-ROESY using echo-antiecho (**hmqcetf3gpro.2**)

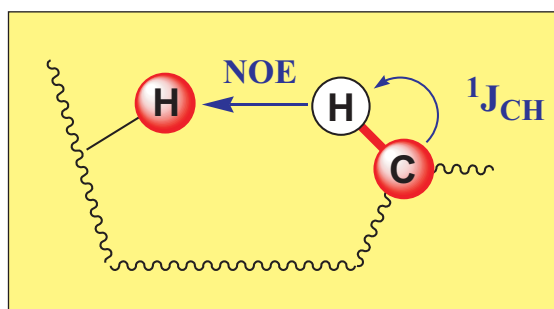

hmqcetgpro

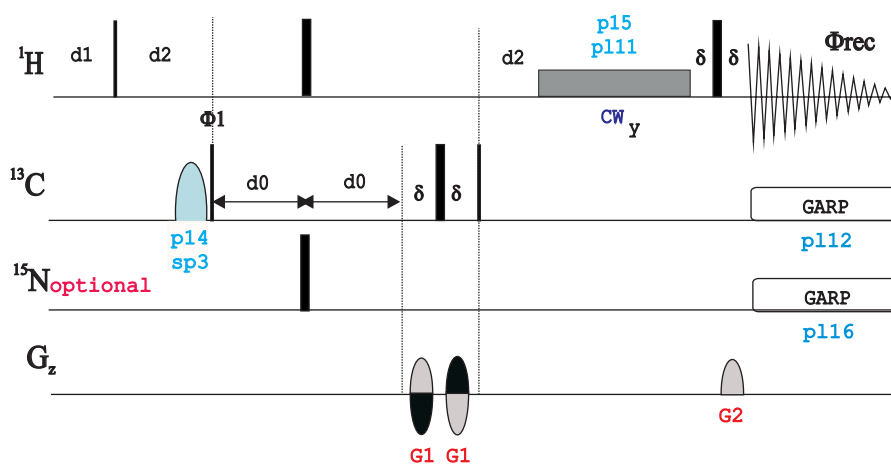

hmqcetgpro.2

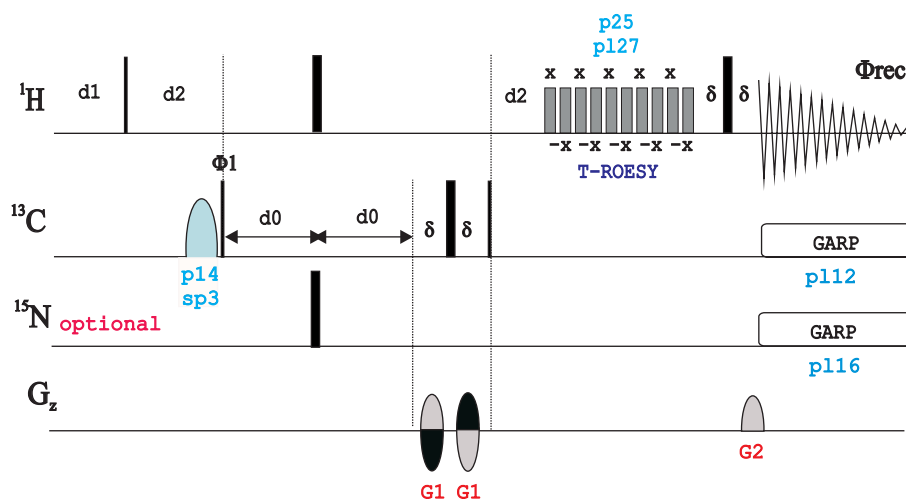

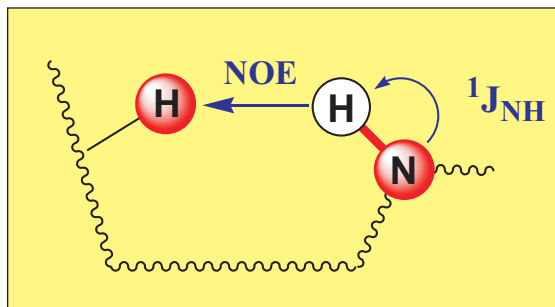

hmqcetf3gpro

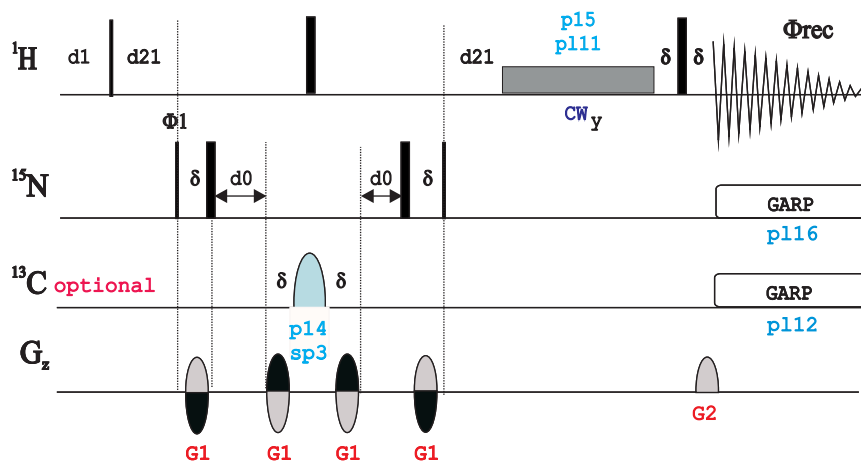

hmqcetf3gpro.2

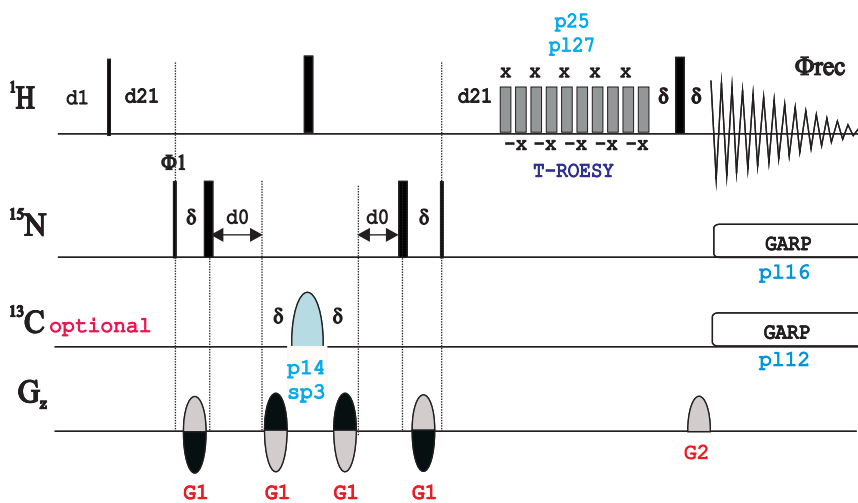

BRUKER PULSE PROGRAM CATALOGUE

NMRGuide

2D HMQC-NOESY EXPERIMENTS

• **Phase cycled:**

Phase-sensitive 2D HMQC-NOESY with presaturation (**hmqcnophpr**)

Phase-sensitive 2D HMQC-NOESY using BIRD (**hmqcbnoph**)

• **Gradient-enhanced from the f2 channel:**

Phase-sensitive ge-2D HMQC-NOESY using echo-antiecho (**hmqcetgpno**)

• **Gradient-enhanced from the f3 channel:**

Phase-sensitive ge-2D ^1H - ^{15}N HMQC-NOESY using echo-antiecho (**hmqctf3gpno**)

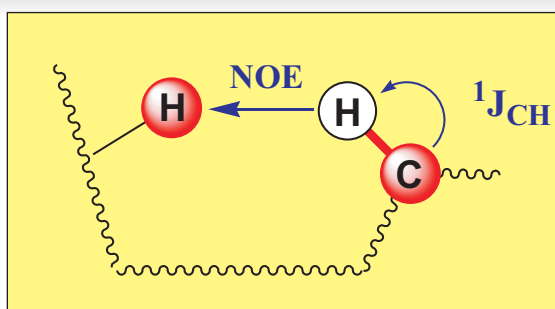

hmqcnophpr

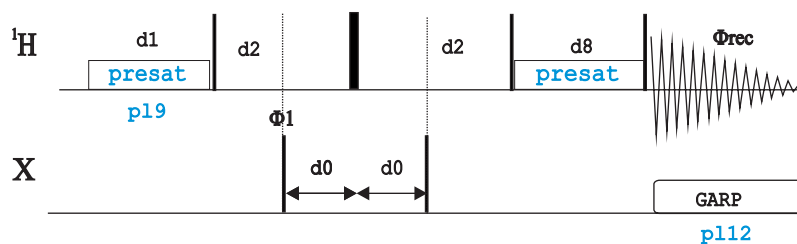

hmqcbnoph

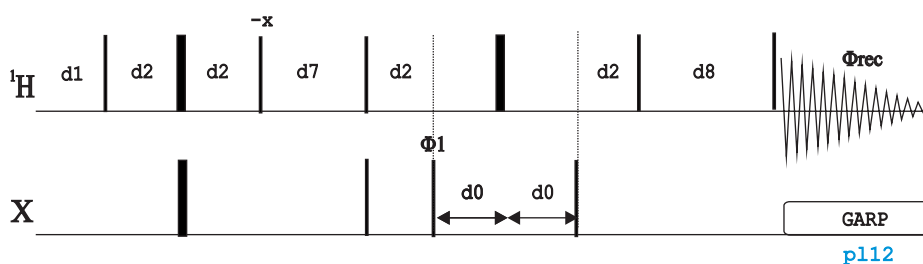

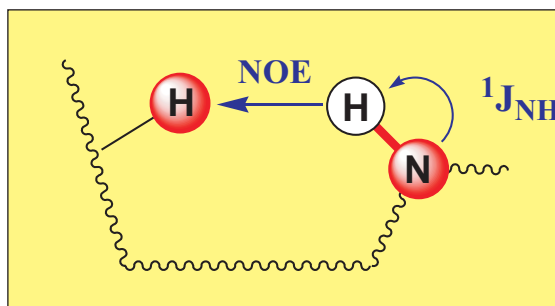

hmqcetgpno

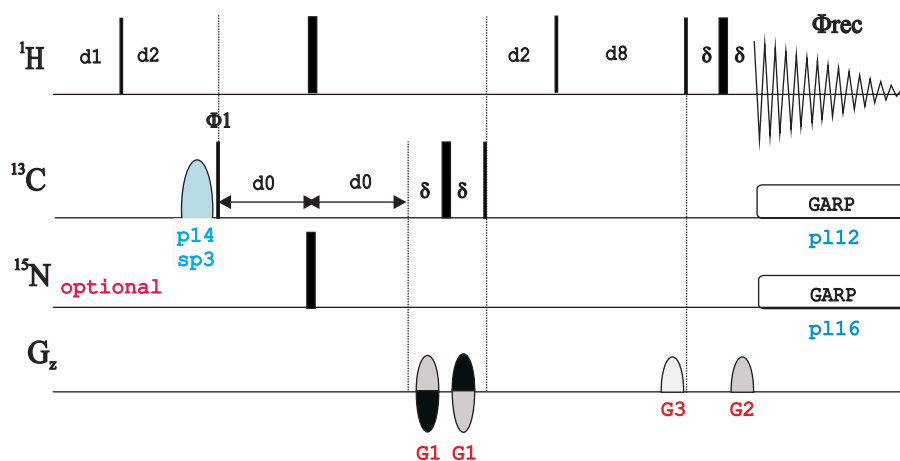

hmqcetf3gpno

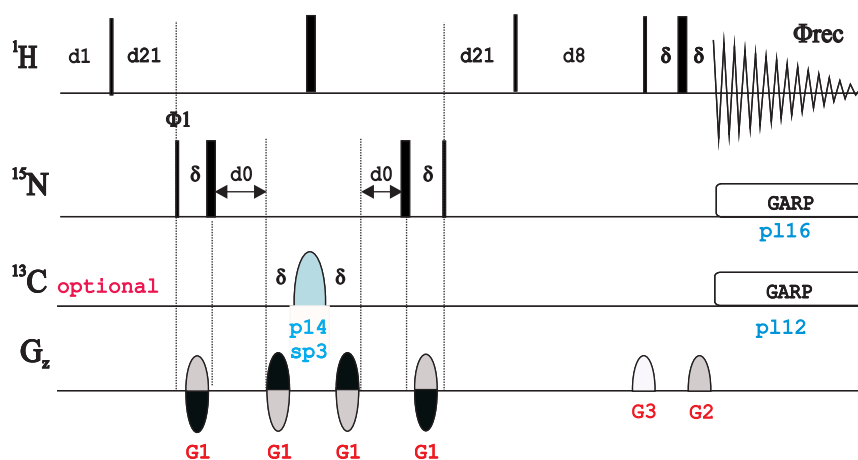

BRUKER PULSE PROGRAM CATALOGUE

NMRGuide

2D HSQC-TOCSY EXPERIMENTS

Gradient-enhanced from the f2 channel

Phase sensitive ge-2D HSQC-TOCSY with MLEV using z-filter (**hsqcgpmlph** | **HSQCGPMLPH**)
 Phase-sensitive ge-2D HSQC-TOCSY with MLEV using echo-antiecho (**hsqcetgpml** | **HSQCETGPML**)
 Phase-sensitive ge-2D HSQC-TOCSY with DIPSI-2 using PEP (**hsqcdietgpsi**)
 Phase-sensitive ge-2D HSQC-TOCSY with DIPSI-2 using PEP and adiabatic inversion pulses (**hsqcdietgpsisp** | **HSQCDIETGPSISP**)
 Phase-sensitive ge-2D HSQC-TOCSY with DIPSI-2 using PEP and adiabatic inversion and refocusing pulses (**hsqcdietgpsisp.2**)

Gradient-enhanced with editing from the f2 channel

Phase sensitive ge-2D HSQC-TOCSY using PEP with editing of multiplicity (**hsqcdiedetgpsisp.1**)
 Phase sensitive ge-2D HSQC-TOCSY using PEP with editing of direct responses (**hsqcdiedetgpsisp.2**)
 Phase sensitive ge-2D HSQC-TOCSY using PEP with editing of multiplicity and direct responses (**hsqcdiedetgpsisp.3**)

Gradient-enhanced from the f3 channel

Phase sensitive ge-2D ¹H-¹⁵N HSQC-TOCSY with MLEV using echo-antiecho (**hsqcetf3gpml**)
 Phase sensitive ge-2D ¹H-¹⁵N HSQC-TOCSY with DIPSI-2 using PEP (**hsqcdietf3gpsi** | **HSQCDIETF3GPSI**)

Also see HSQC-TOCSY type experiments for ⁿJ_{CH} measurements

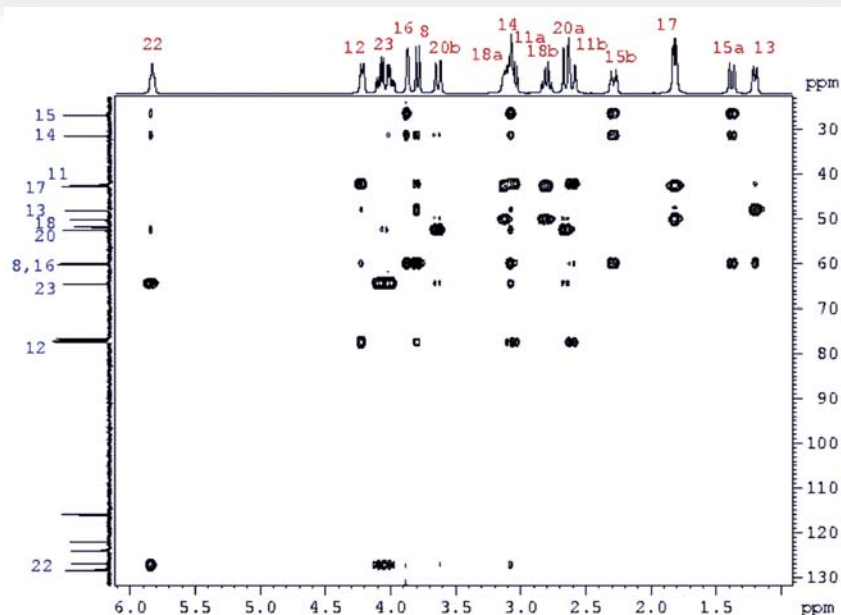

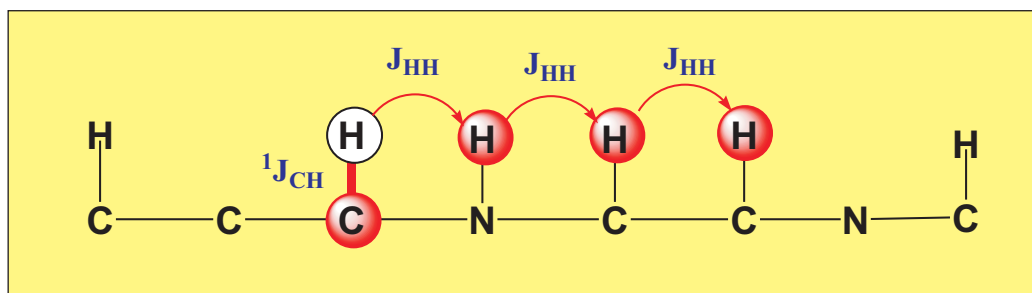

hsqcgpmiph

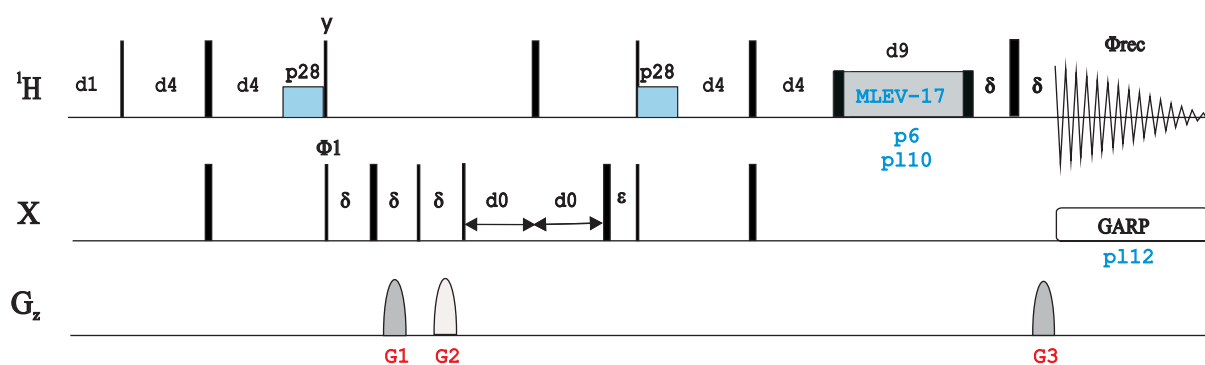

hsqcetgpmi

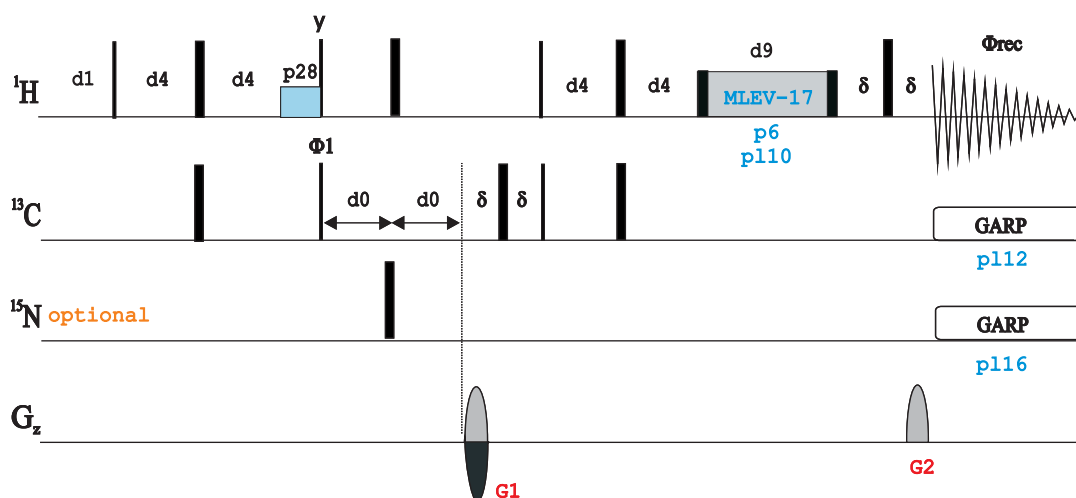

hsqc dietgpsi

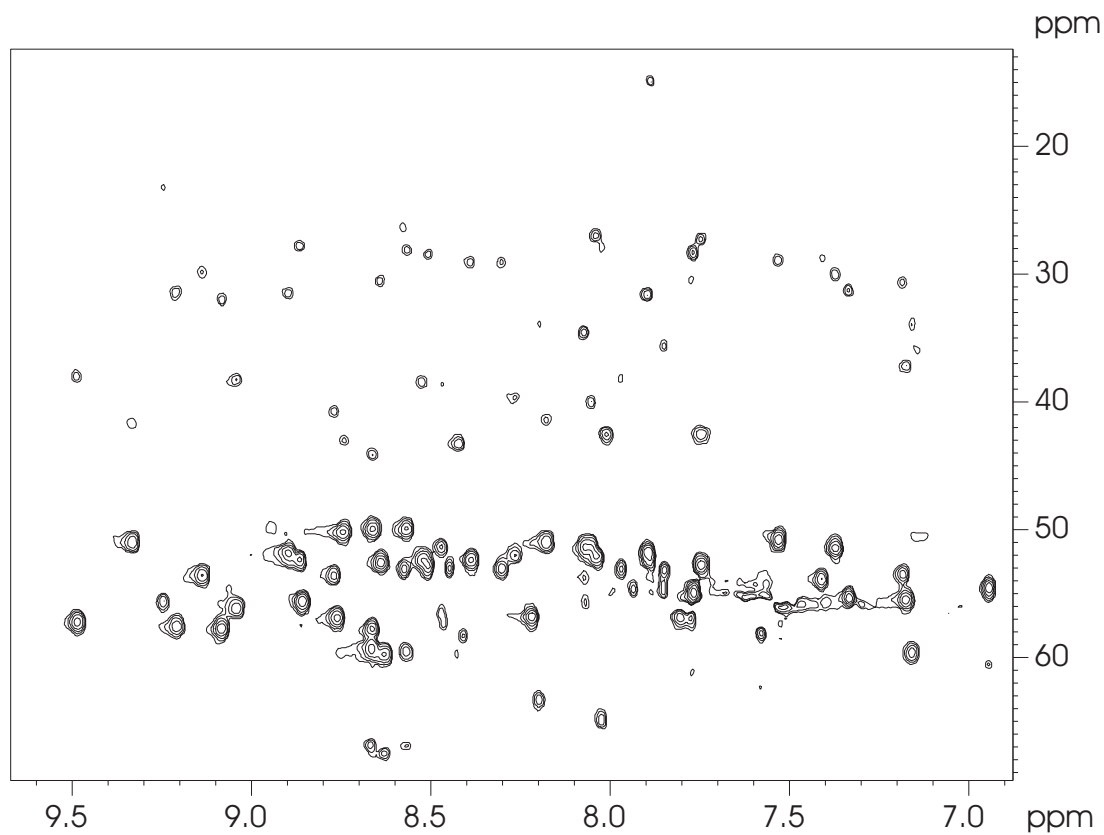
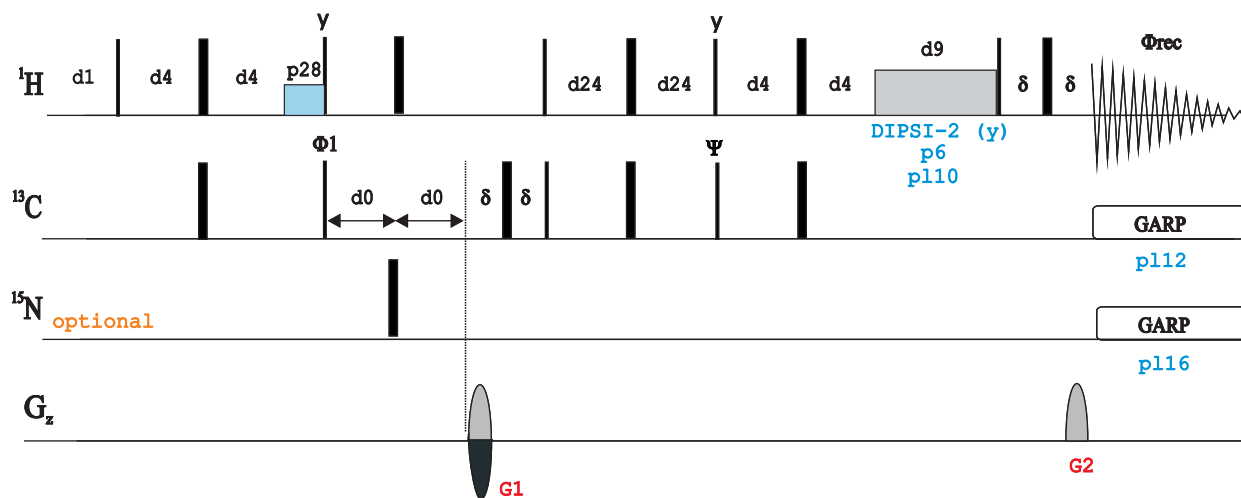

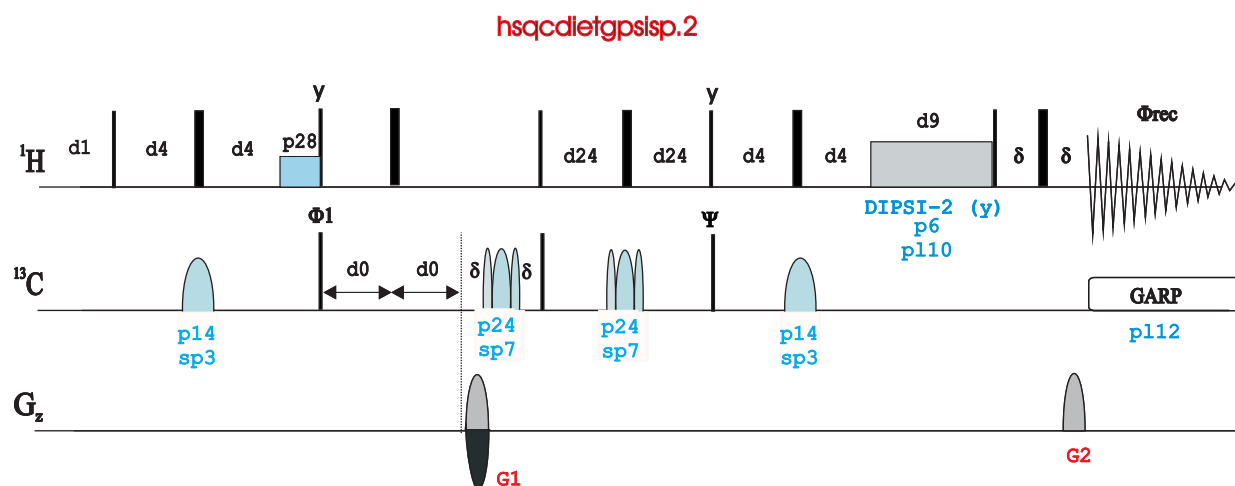
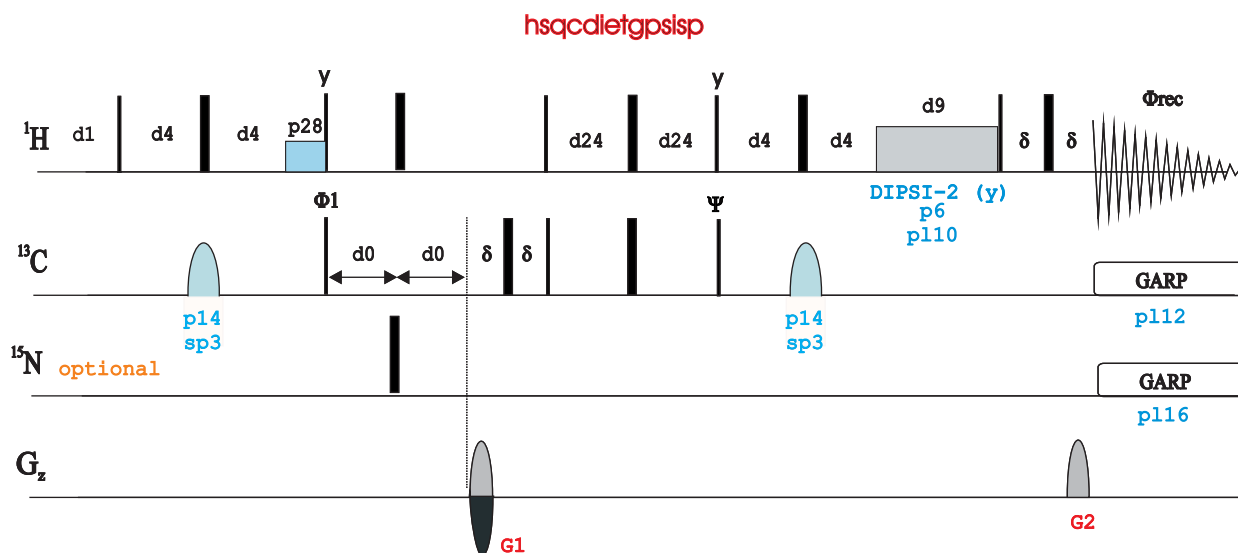

hsqcledetgpsisp.1

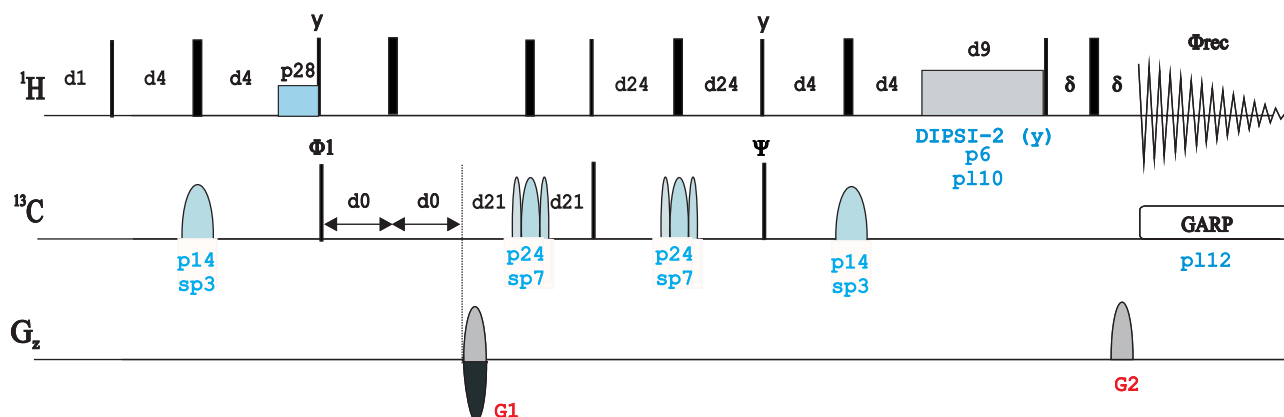

hsqcledetgpsisp.2

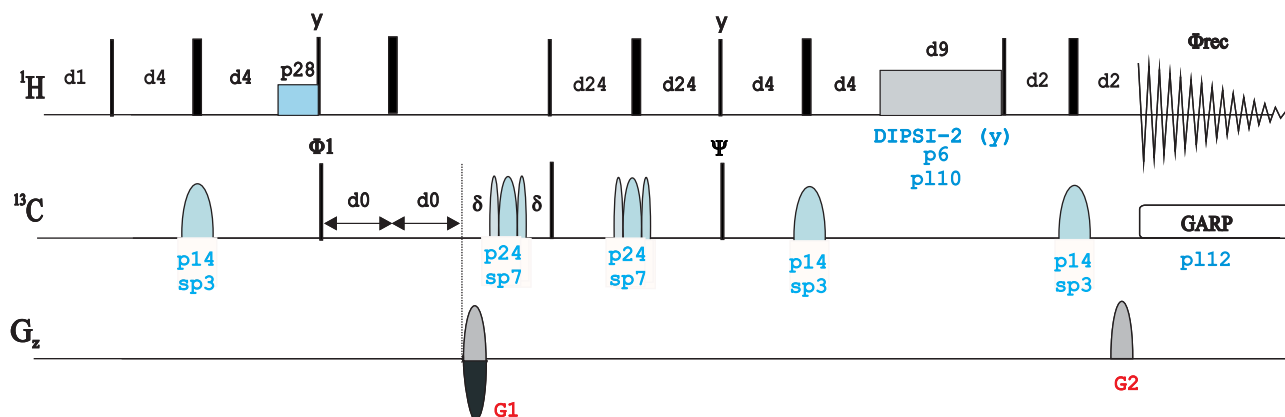

hsqcledetgpsisp.3

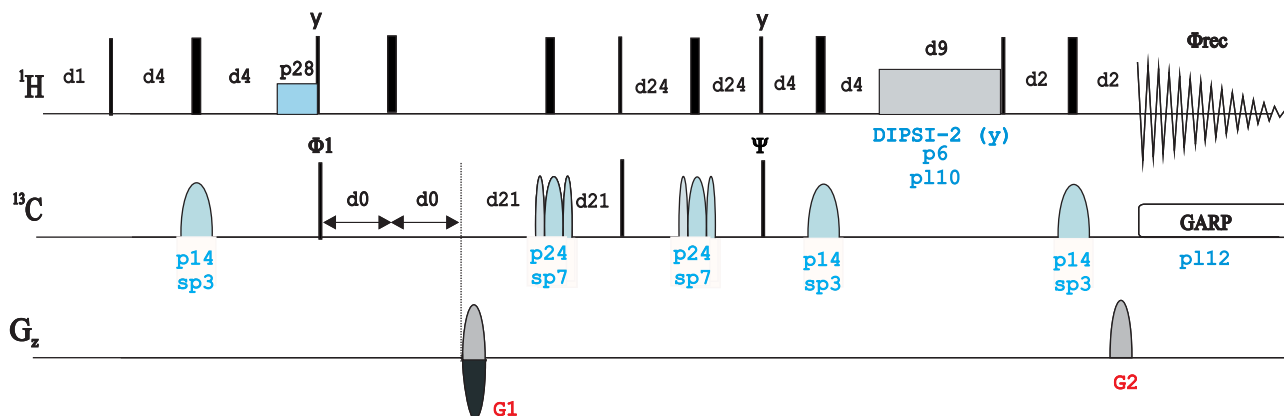

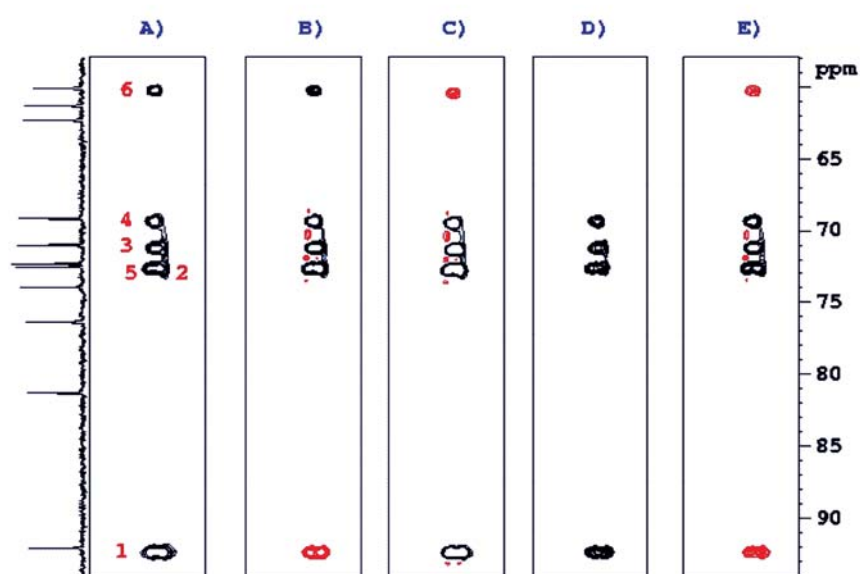
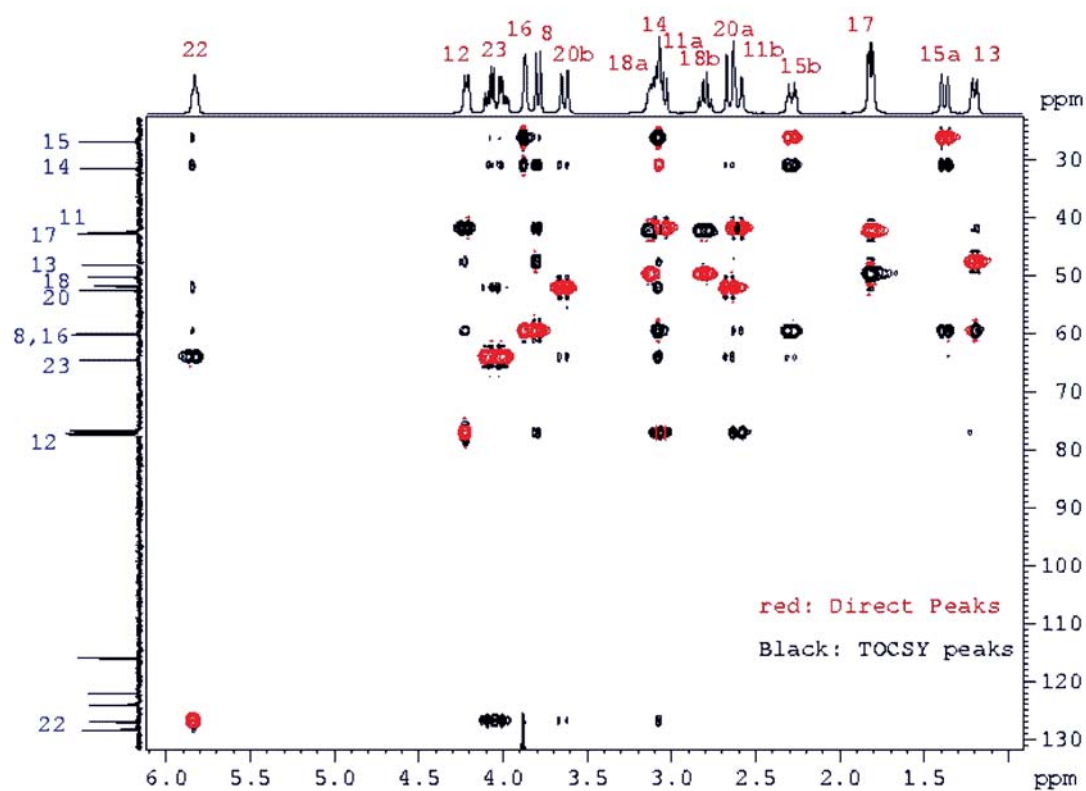

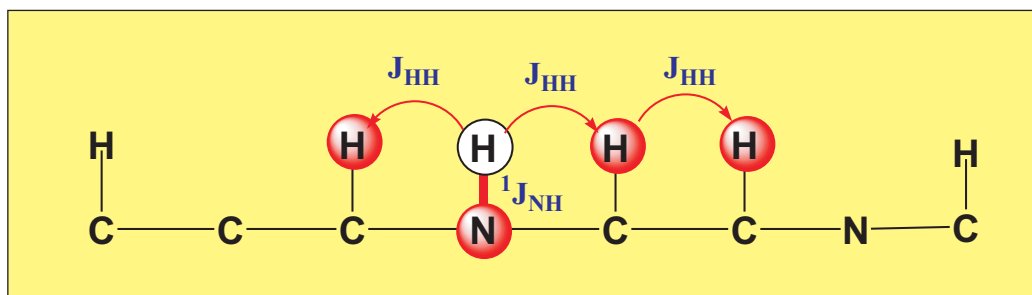

hsqcetf3gpml

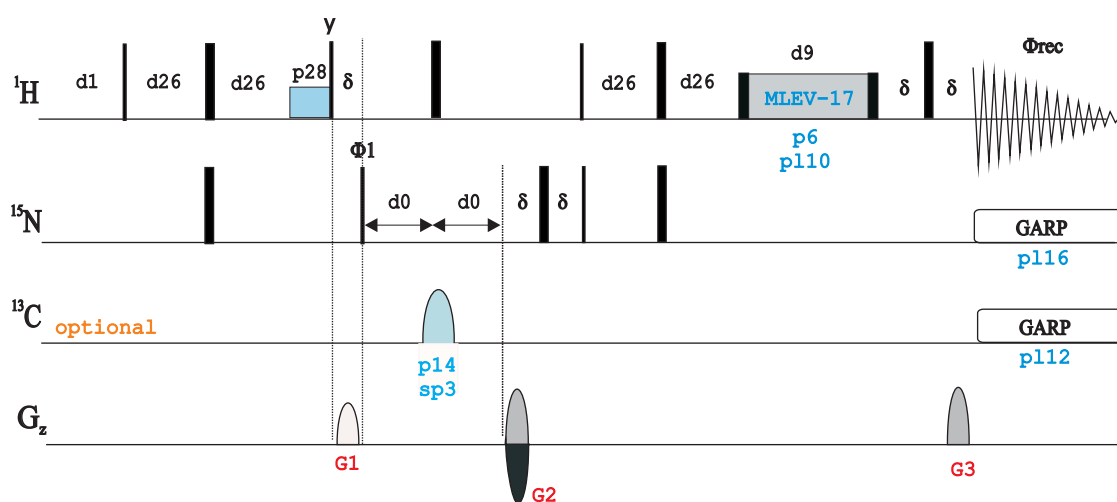

hsqcdleff3gpsi

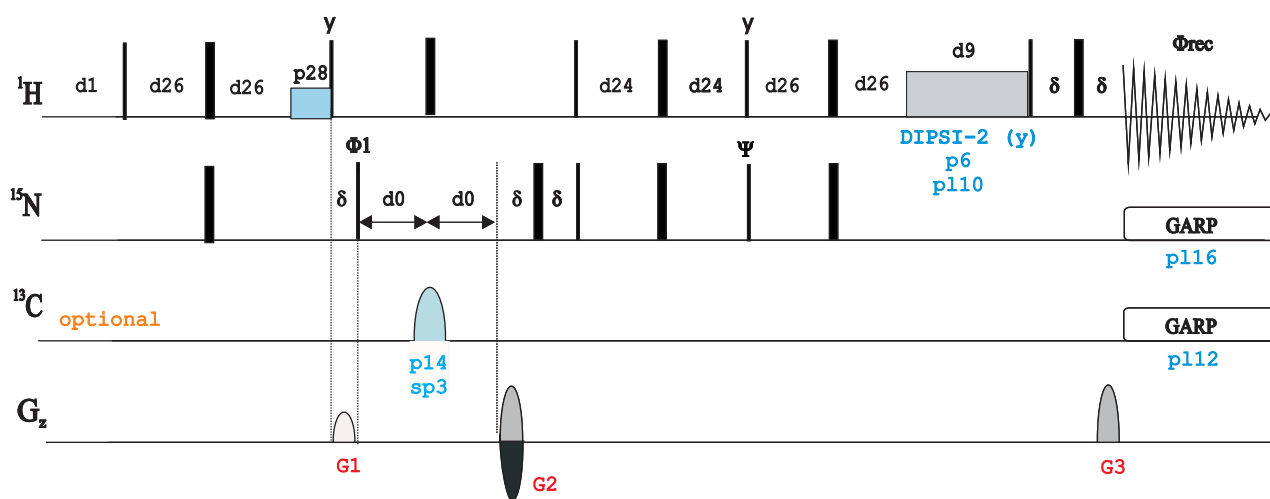

BRUKER PULSE PROGRAM CATALOGUE

NMRGuide

2D HSQC-ROESY EXPERIMENTS

- **Gradient-enhanced from the f2 channel**

Phase-sensitive ge-2D HSQC-ROESY using echo-antiecho and adiabatic pulses
(**hsqcetgprosp** | **HSQCETGPROSP**)

Phase-sensitive ge-2D HSQC-ROESY using echo-antiecho and adiabatic pulses with T-ROESY(**hsqcetgprosp.2**)

- **Gradient-enhanced from the f3 channel**

Phase-sensitive ge-2D ^1H - ^{15}N HSQC-ROESY using echo-antiecho (**hsqcetf3gpro**)

Phase-sensitive ge-2D ^1H - ^{15}N HSQC-ROESY with T-ROESY using echo-antiecho
(**hsqcetf3gpro.2**)

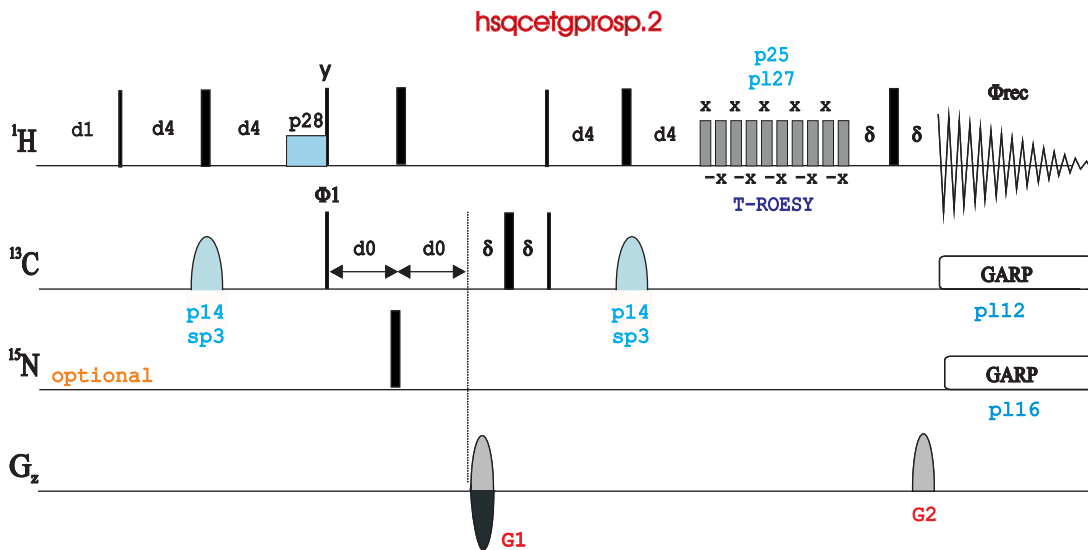
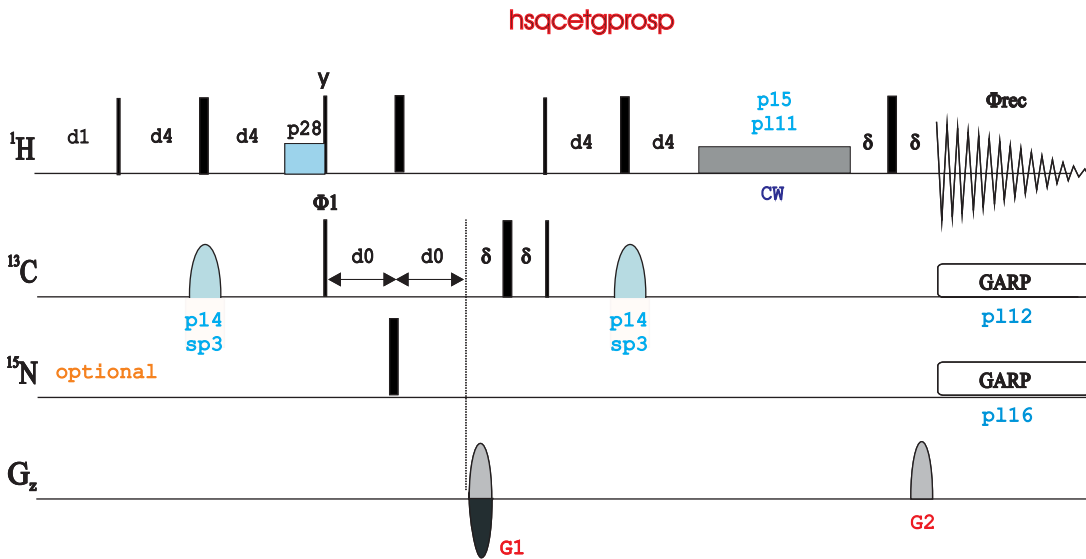
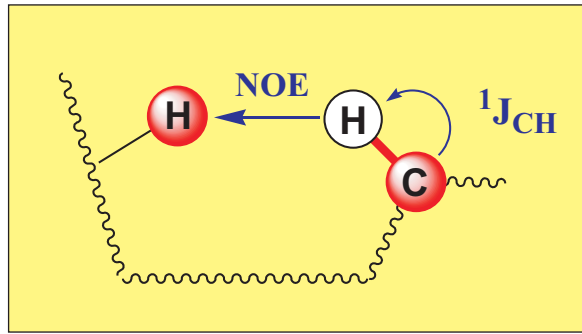

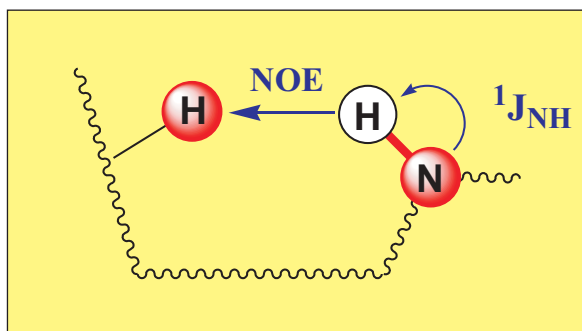

hsqcetf3gpro

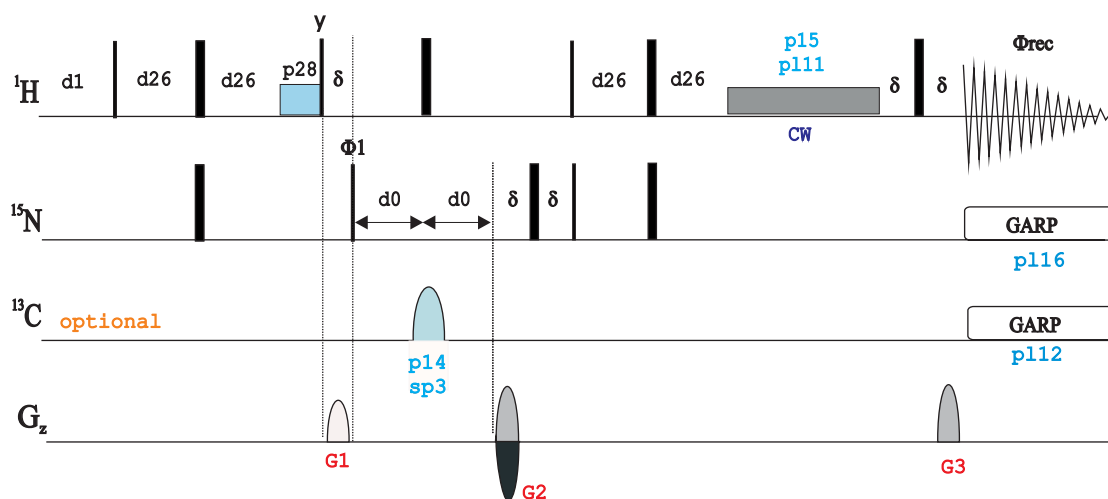

hsqcetf3gpro.2

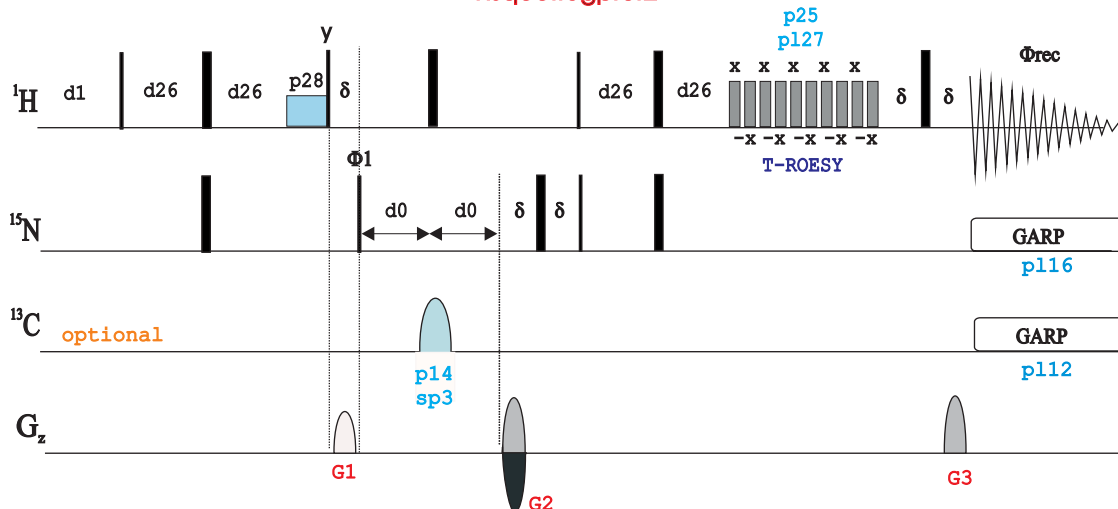

BRUKER PULSE PROGRAM CATALOGUE

NMRGuide

2D HSQC-NOESY EXPERIMENTS

• **Gradient-enhanced from the f2 channel**

Phase-sensitive ge-2D HSQC-NOESY using echo-antiecho and adiabatic pulses (**hsqcetgpnosp** | HSQCETGPNOSP)

• **Gradient-enhanced from the f3 channel**

Phase-sensitive ge-2D ^1H - ^{15}N HSQC-NOESY using echo-antiecho (**hsqcetf3gpno** | HSQCETF3GPNO)

Phase-sensitive ge-2D ^1H - ^{15}N HSQC-NOESY using XY16 and WATERGATE (**hsqcf3gpnowgxy**)

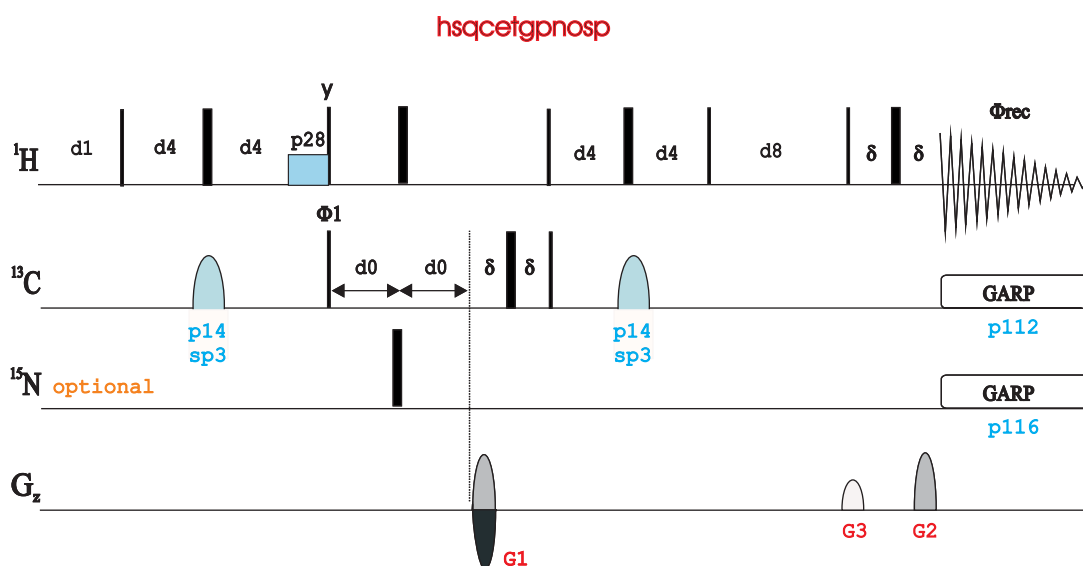
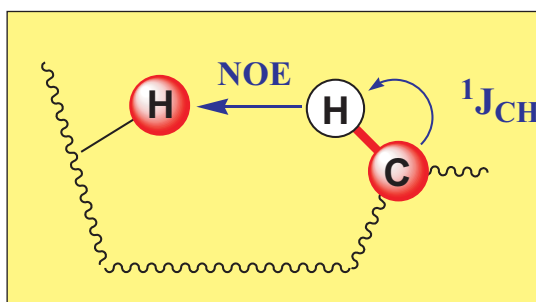

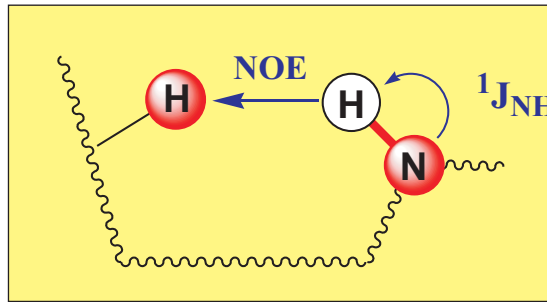

hsqcetf3gpno

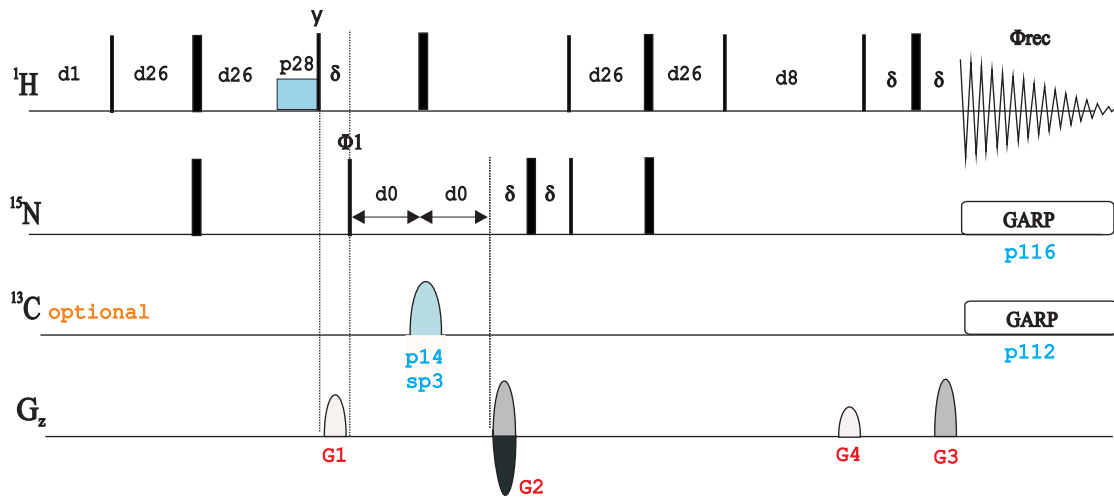

hsqcf3gpnowgxy

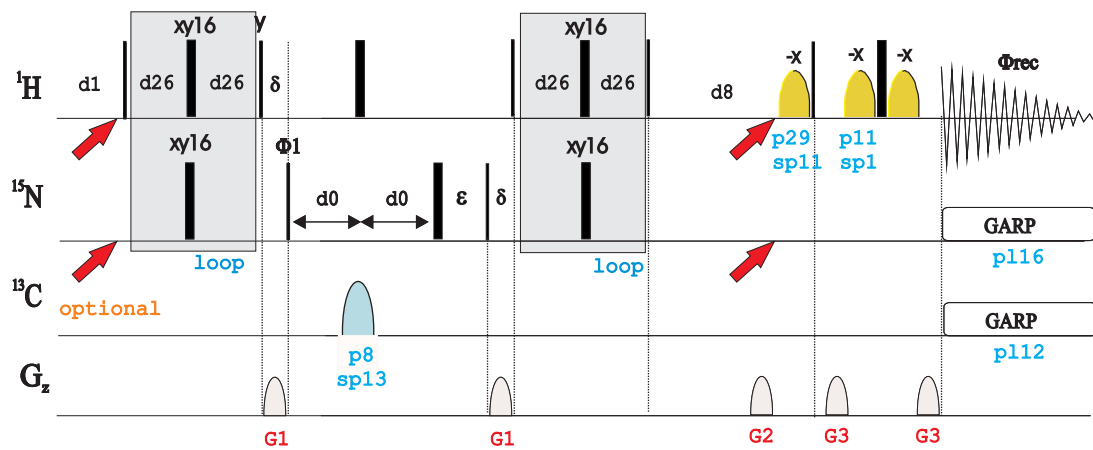

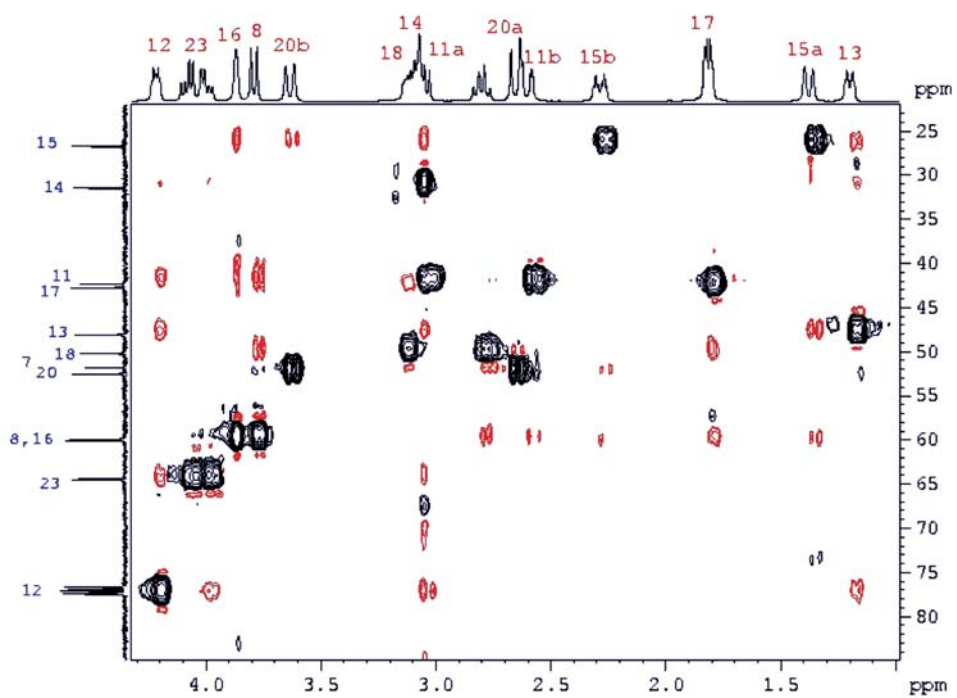

BRUKER PULSE PROGRAM CATALOGUE

NMRGuide

2D HMBC EXPERIMENTS

Phase cycled:

Magnitude-mode 2D HMBC using low-pass J-filter (**hmbclpndqf** | HMBCLPND)
 Magnitude-mode 2D HMBC with presaturation (**hmbcndprqf**)
 Magnitude-mode 2D HMBC with off-resonance presaturation (**hmbcndpsqf**)

Gradient-based:

Magnitude-mode ge-2D HMBC (**hmbcgpndqf** | HMBCGPND)
 Magnitude-mode ge-2D HMBC using low-pass J-filter (**hmbcgplpndqf** | HMBCGPLPND)
 Magnitude-mode ge-2D HMBC using double low-pass J-filter (**hmbcgpl2ndqf**)

Magnitude-mode band-selective ge-2D HMBC without decoupling (**shmbcgpndqf**)

Magnitude-mode CIGAR-HMBC without decoupling (**hmbcacgplpndqf**)
 Magnitude-mode CIGAR-HMBC with decoupling (**hmbcacgplpqf**)
 ge-2D 2J,3J HMBC, STAR-HMBC (**hmbcacbigpl2ndqf**)
 ge-2D HSMC (**hmscetgpnd**)

Also see:

- Measurement of long-range proton-carbon coupling constants
- 2D COLOC Experiment
- ADEQUATE Experiments

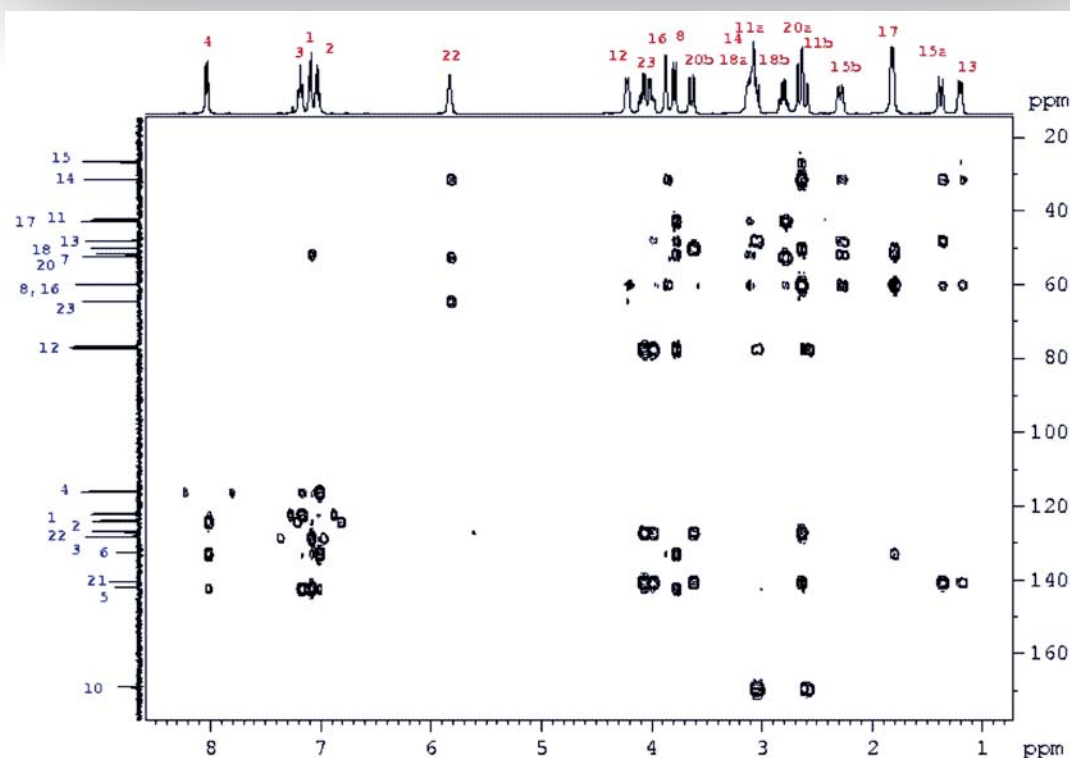

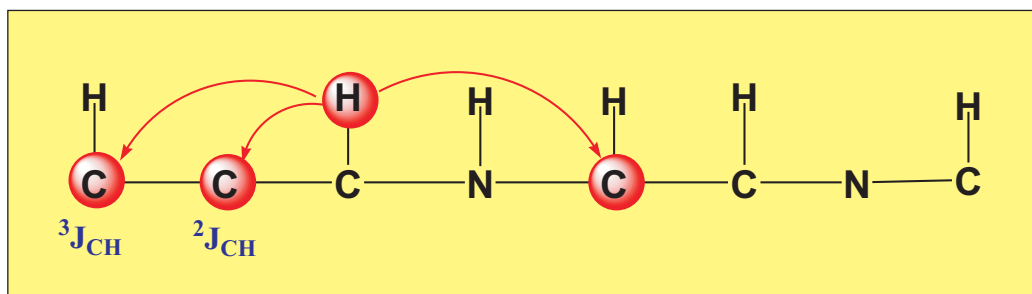

hmbc1pndqf

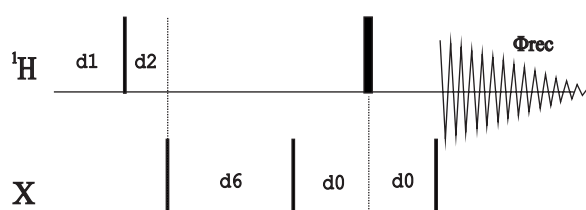

hmbcndprqf

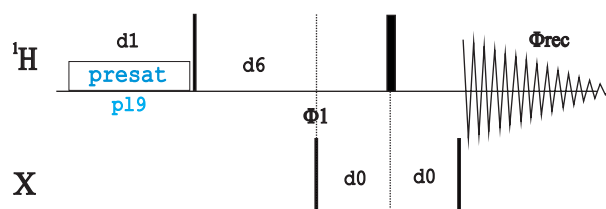

hmbcndpsqf

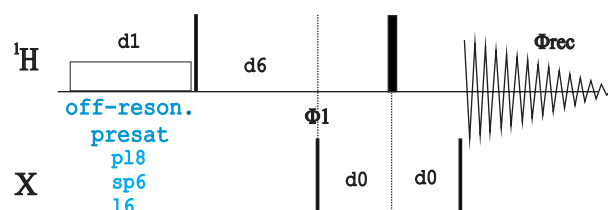

hmbcgpndqf

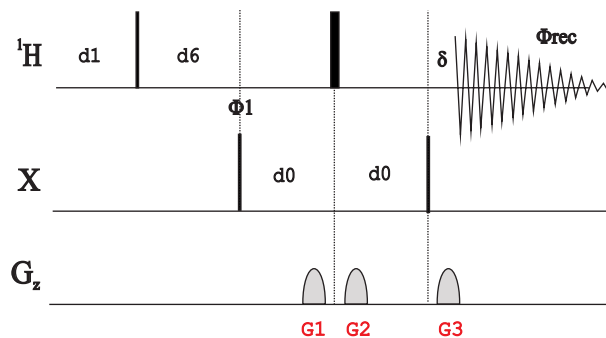

hmbcgpipndqf

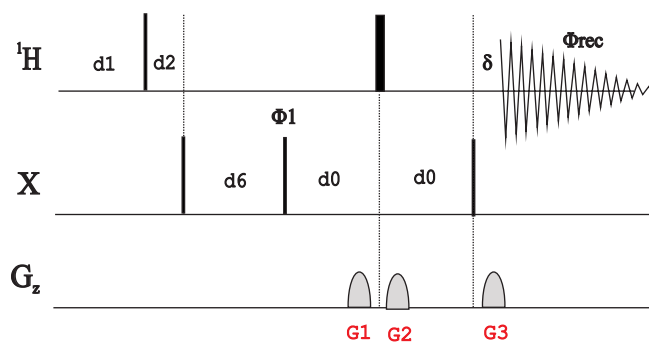

hmbcgp12ndqf

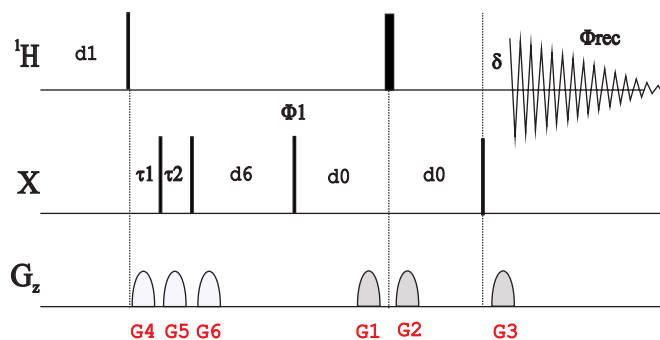

shmbcgpndqf

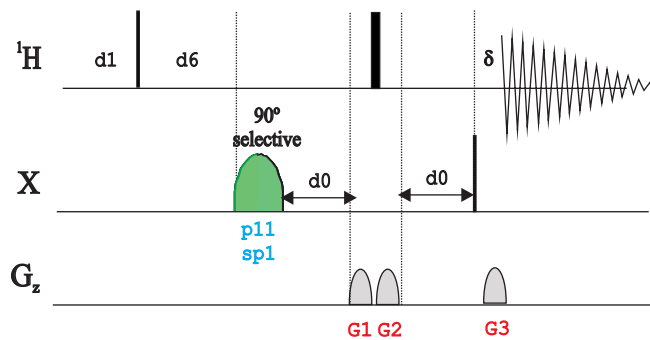

hmbcacgplpqf

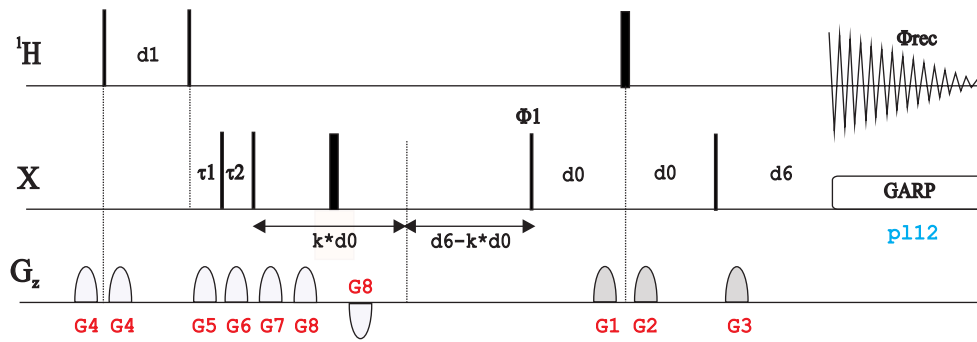

hmbcacgplpdqf

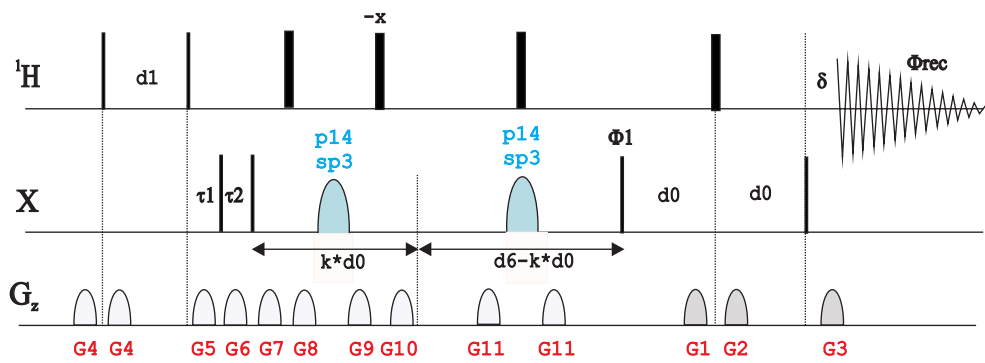

hmbcacbigpl2ndqf

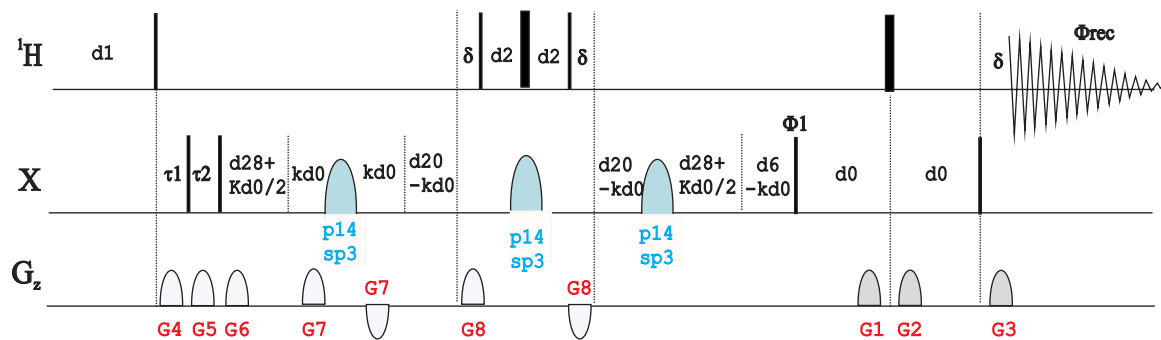

hmscetgpd

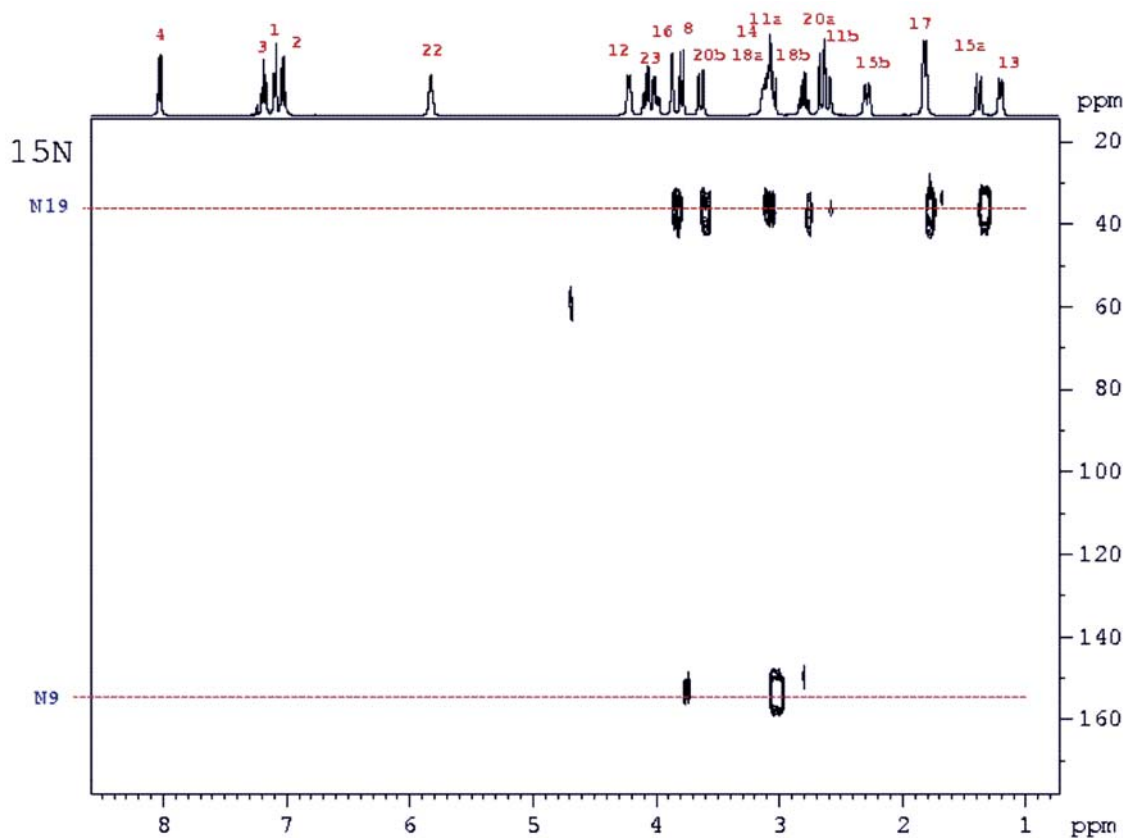
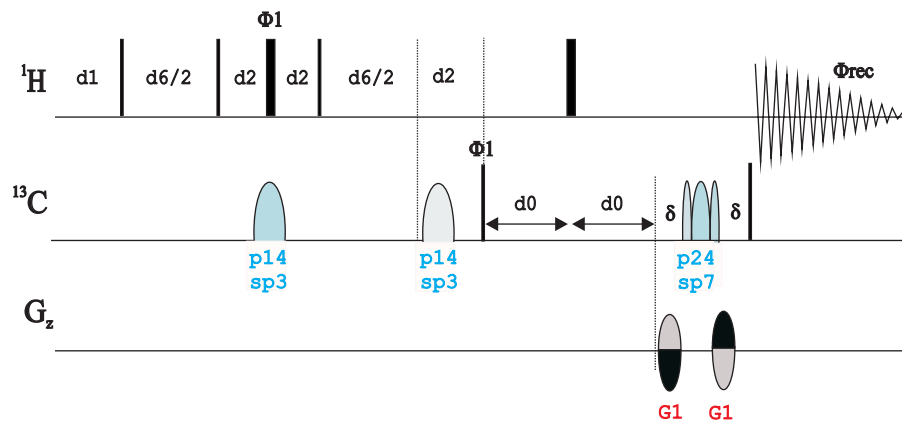

BRUKER PULSE PROGRAM CATALOGUE

NMRGuide

2D EXPERIMENTS TO MEASURE
LONG-RANGE PROTON-CARBON
COUPLING CONSTANTS

ge-2D HMBC-type experiments

Phase-sensitive ge-2D HMBC using echo-antiecho (**hmbcetgpnd**)
Phase-sensitive ge-2D HMBC using a two-fold low-pass J-filter (**hmbcetgpl2nd**)

Phase-sensitive ge-2D CT-HMBC using echo-antiecho (**hmbcctetgpnd**)

ge-2D J-HMBC using a two-fold low-pass J-filter (**hmbcetgpjcl2nd**)

Long-range optimized ge-2D HSQC

Phase-sensitive ge-2D long-range optimized HSQC (HSQMBC) (**hsqcetgplrsp**)
Phase-sensitive ge-2D long-range optimized HSQC using G-BIRD (GBIRD-HSQMBC) (**hsqcetgpjclrnd**)
ge-2D long-range optimized J-HSQC (EXSIDE) (**hsqcetgplrjcspl**)

ge-2D HSQC-TOCSY type experiments

ge-2D w1-filtered TOCSY using DIPSI-2 (HETLOC) (**dipsi2etgpjcsix1**)
Phase-sensitive ge-2D HSQC-HECADE (**hsqcdietgpjendsisp**)

Also see 2D HMBC and 2D HSQC-TOCSY experiments

HSQC-TOCSY

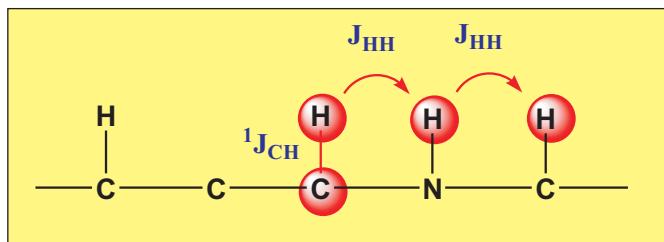

HMBC

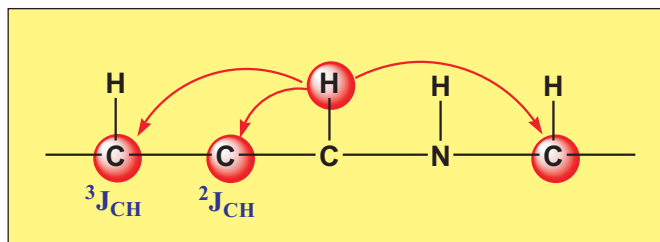

Others: HMQC-TOCSY, HECADE, HETLOC
Two steps: $^1J_{CH}$ + J_{HH}
Only for protonated carbons
In-phase Magnetization

Others: HSQMBC, EXSIDE, J-HMBC
A single step: $^nJ_{CH}$
For all carbons
Anti-phase Magnetization

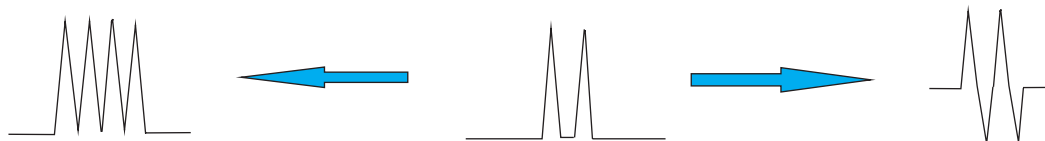

J-scaling factor of N

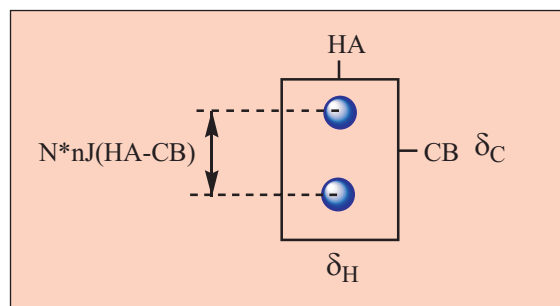

hmbcetgpjcl2nd

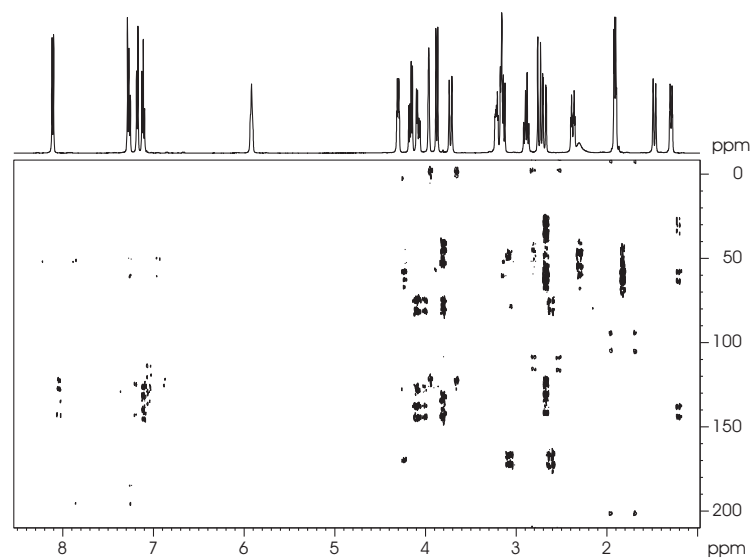
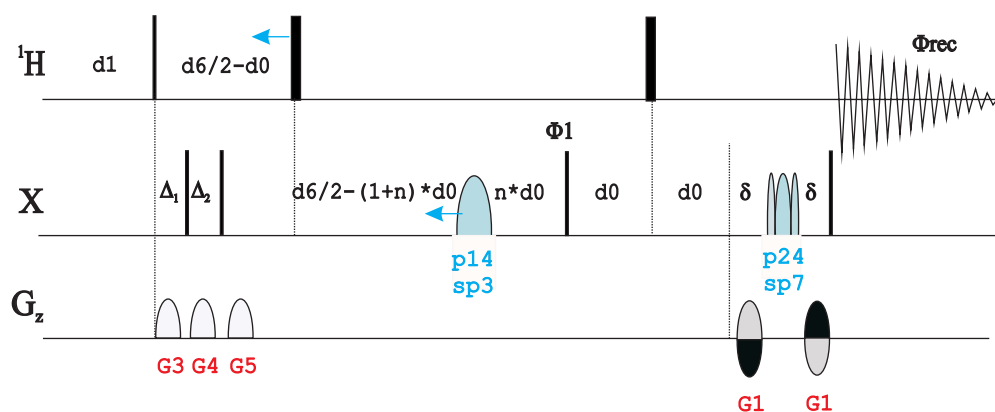

J-scaling factor of N

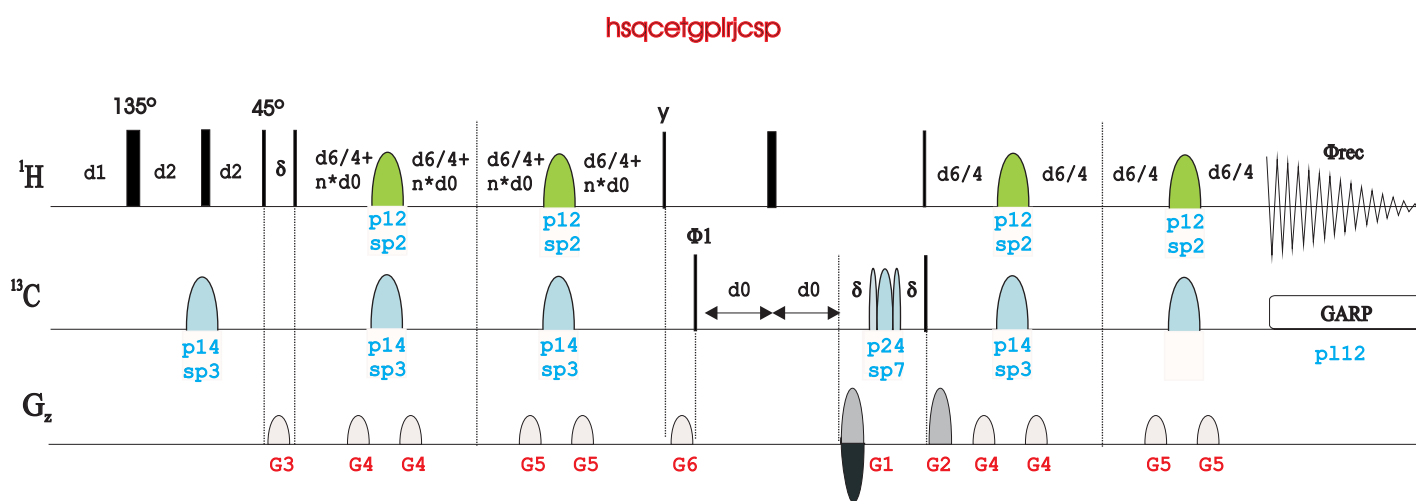
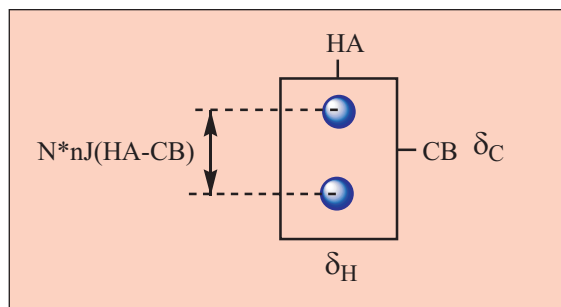

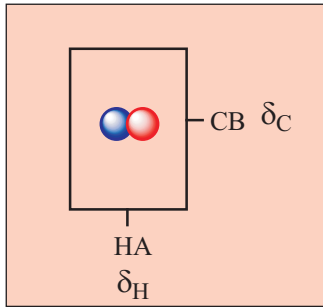

hmbcetgpnd

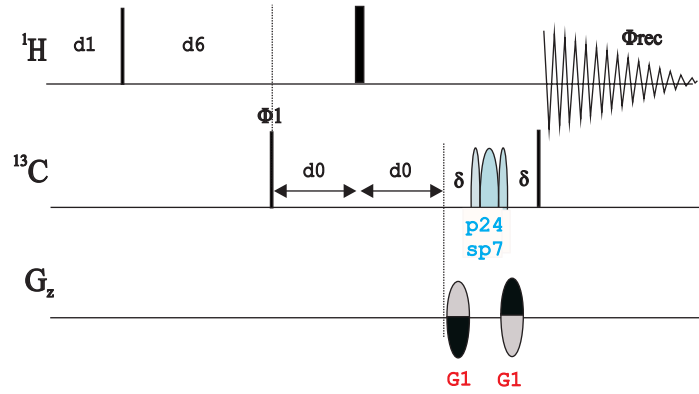

hmbcetgpl2nd

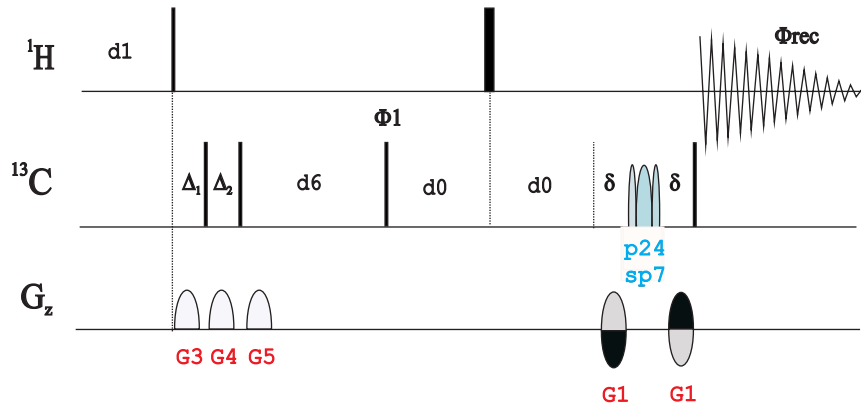

hmbccetgnd

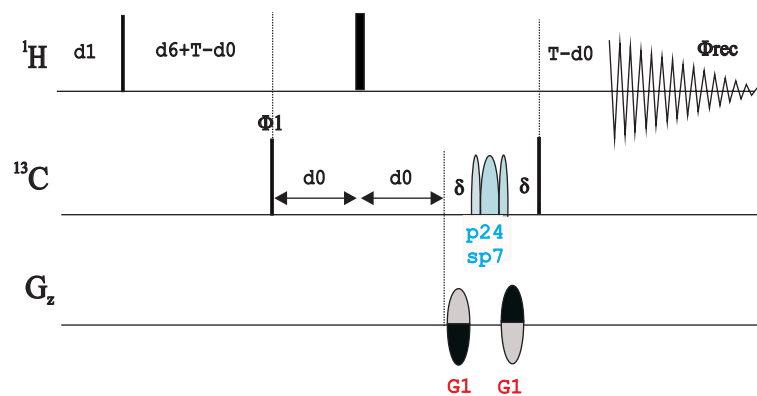

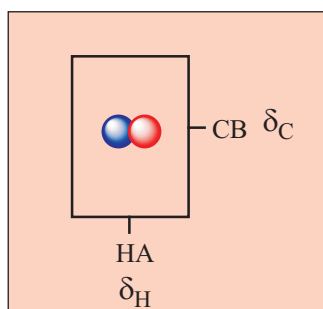

hsqcetgplrsp

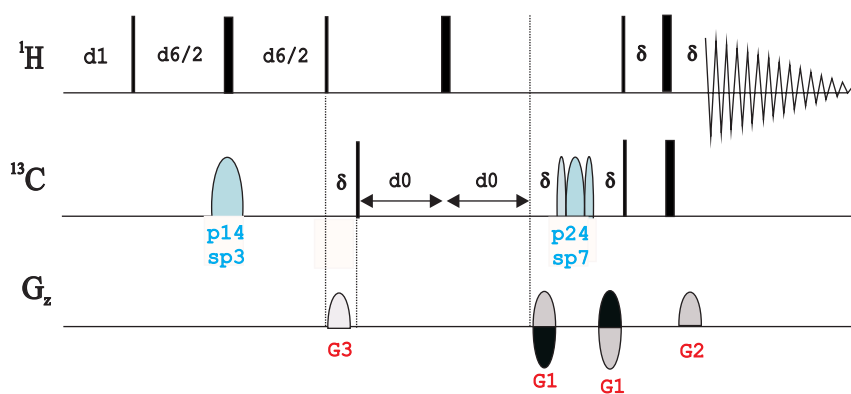

hsqcetgplclnd

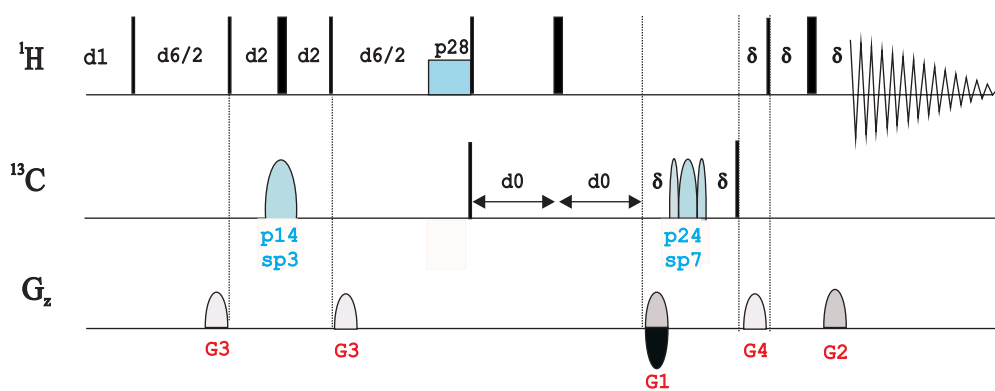

J-scaling factor of N

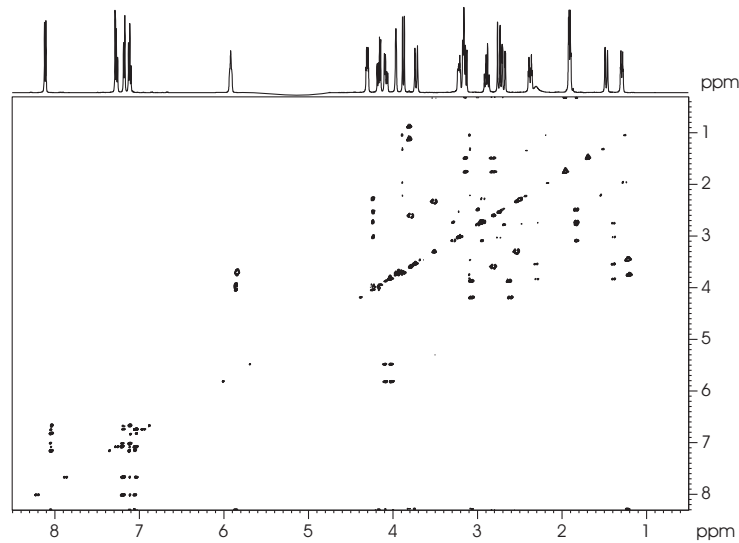
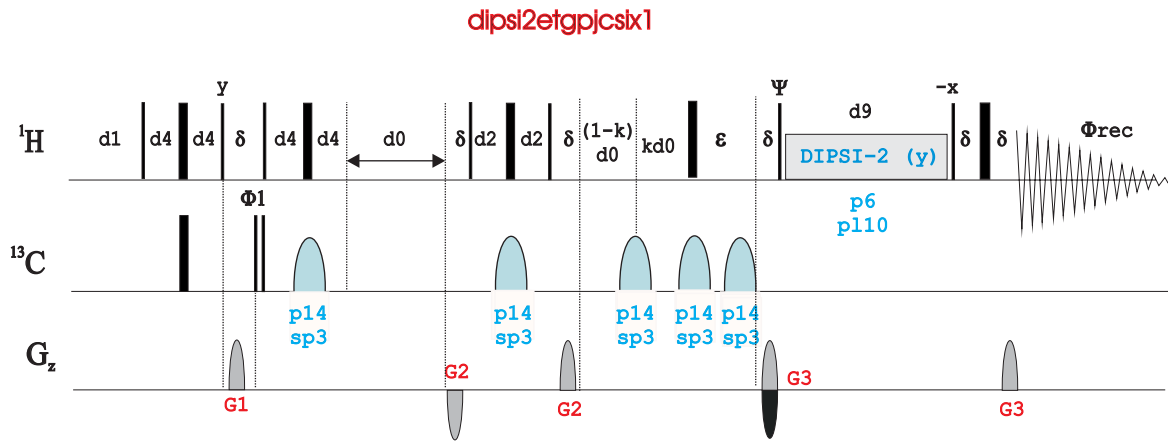
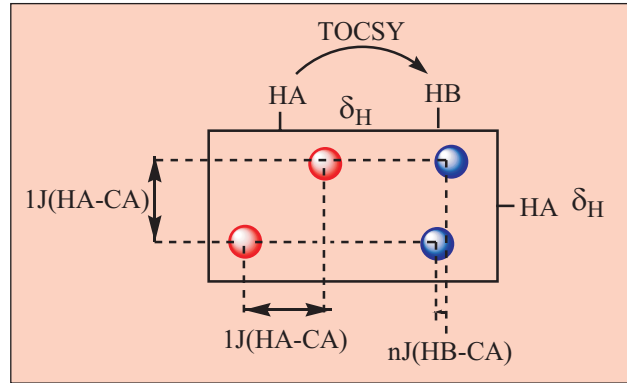

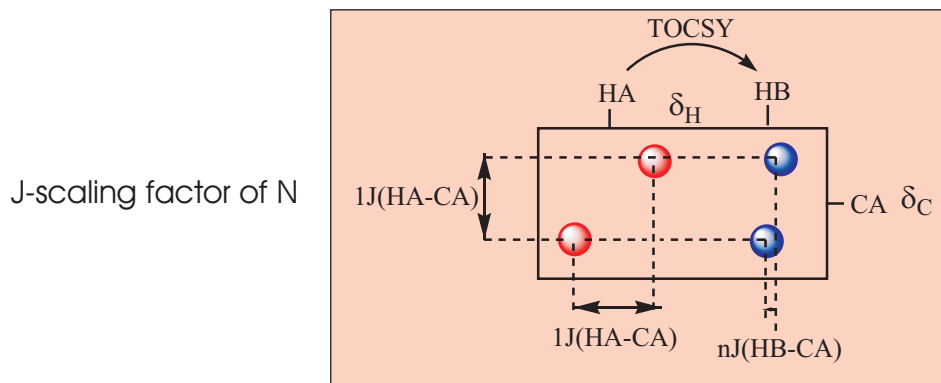

hsqcaldietgpjncdlsip

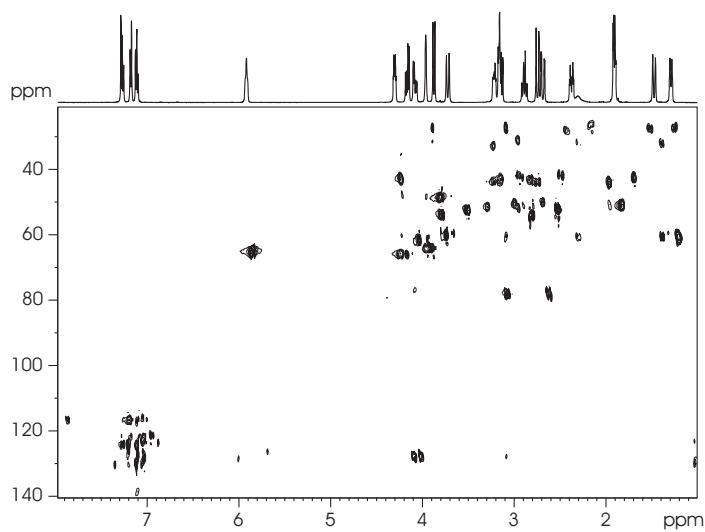
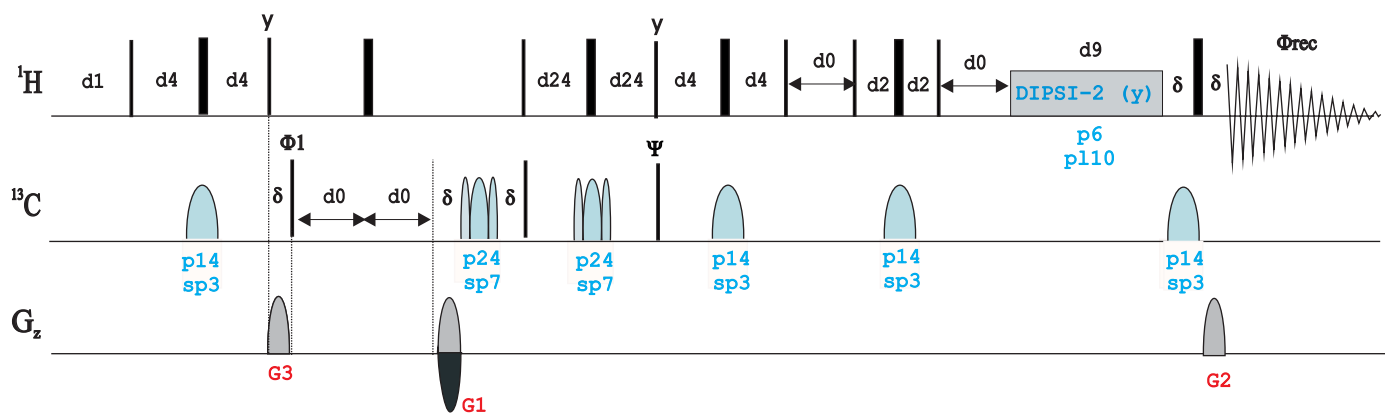

BRUKER PULSE PROGRAM CATALOGUE

NMRGuide

2D ADEQUATE EXPERIMENTS

- **1,1-ADEQUATE:**

Phase-sensitive 1,1 ADEQUATE (**adeq11etgp**)

Phase-sensitive 1,1 ADEQUATE using adiabatic pulse (**adeq11etgpsp**)

Phase-sensitive 1,1 ADEQUATE with refocusing (**adeq11etgprd**)

Phase-sensitive 1,1 ADEQUATE with refocusing using adiabatic pulse (**adeq11etgprdsp**)

- **1,n-ADEQUATE:**

Phase-sensitive 1,n ADEQUATE (**adeq1netgp**)

- **n,1-ADEQUATE:**

Phase-sensitive n,1 ADEQUATE (**adeqn1etgp**)

- **n,n-ADEQUATE:**

Phase-sensitive n,n ADEQUATE (**adeqnnetgp**)

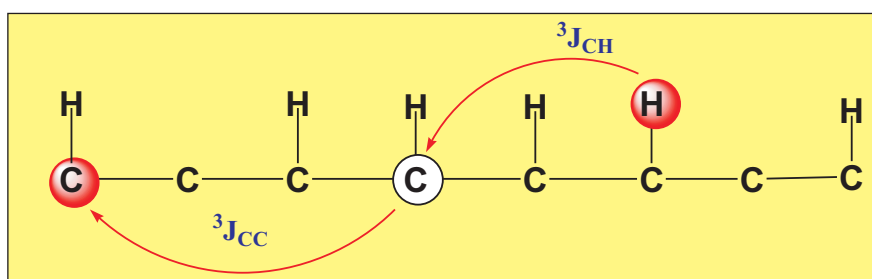
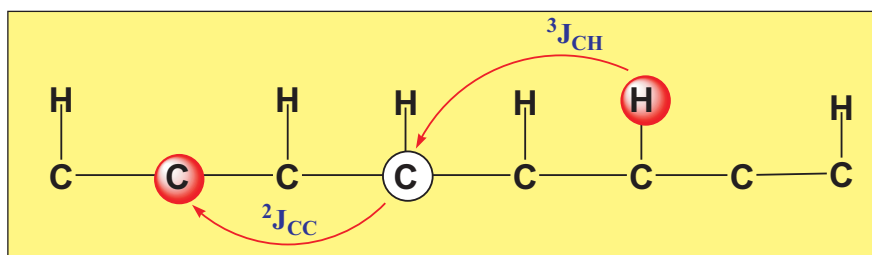
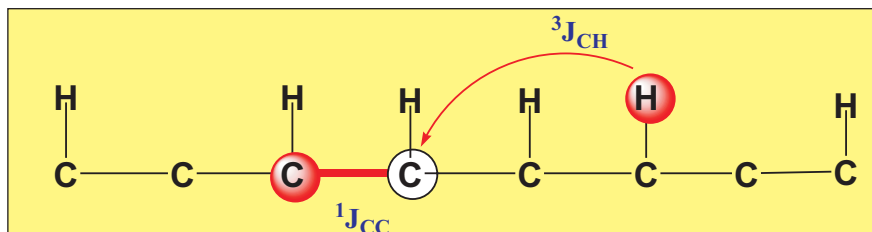
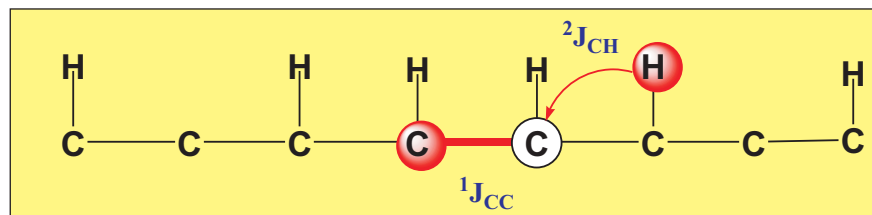
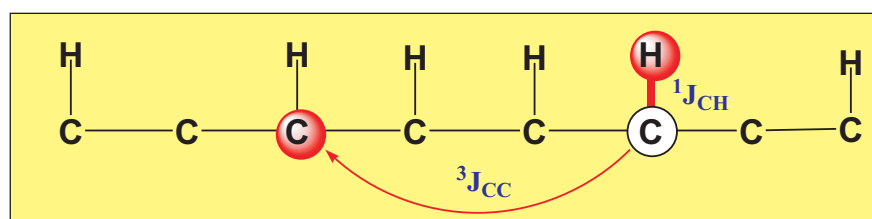
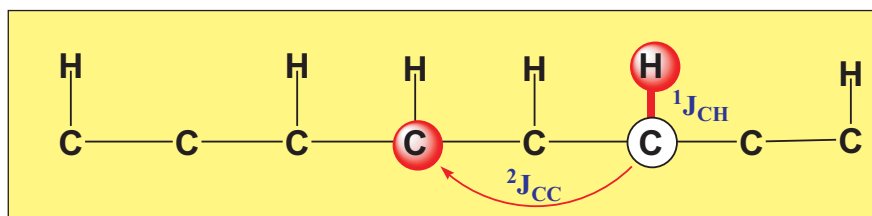
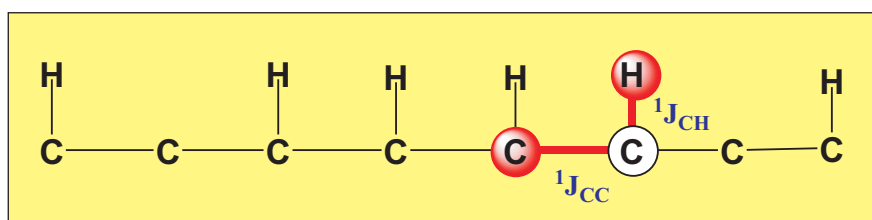

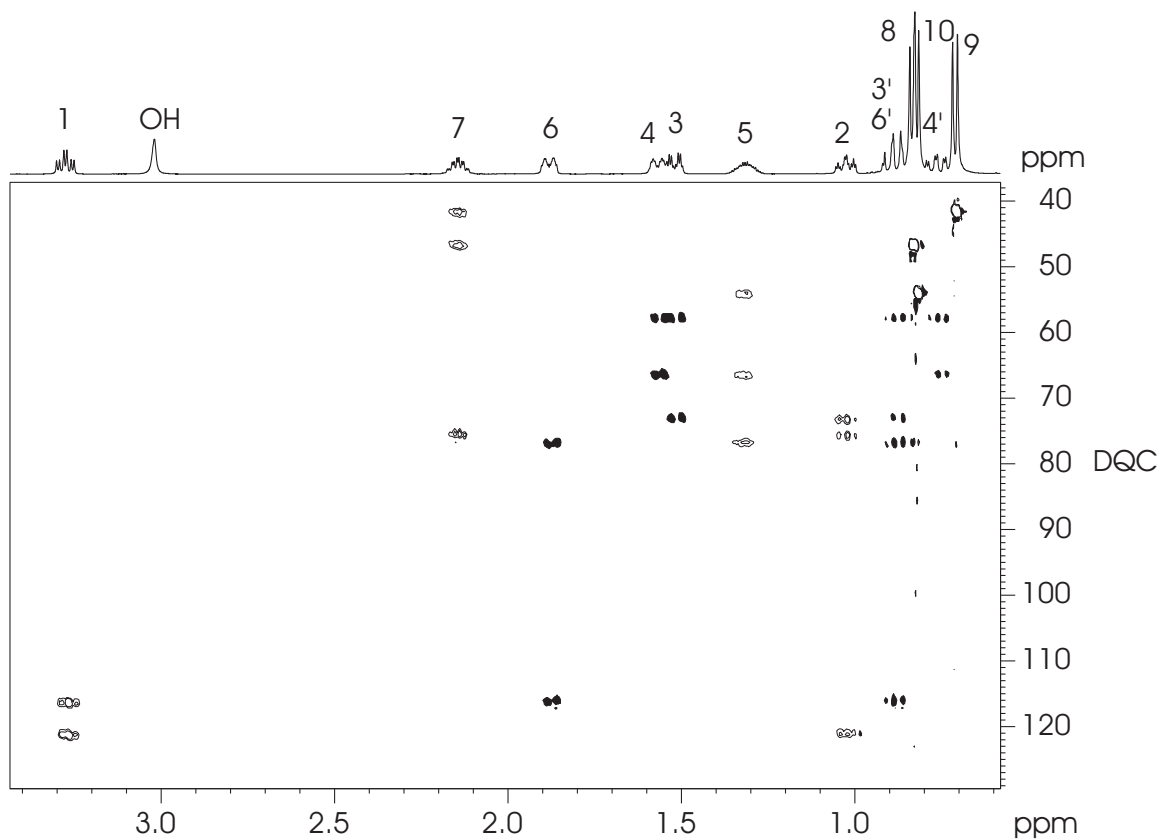
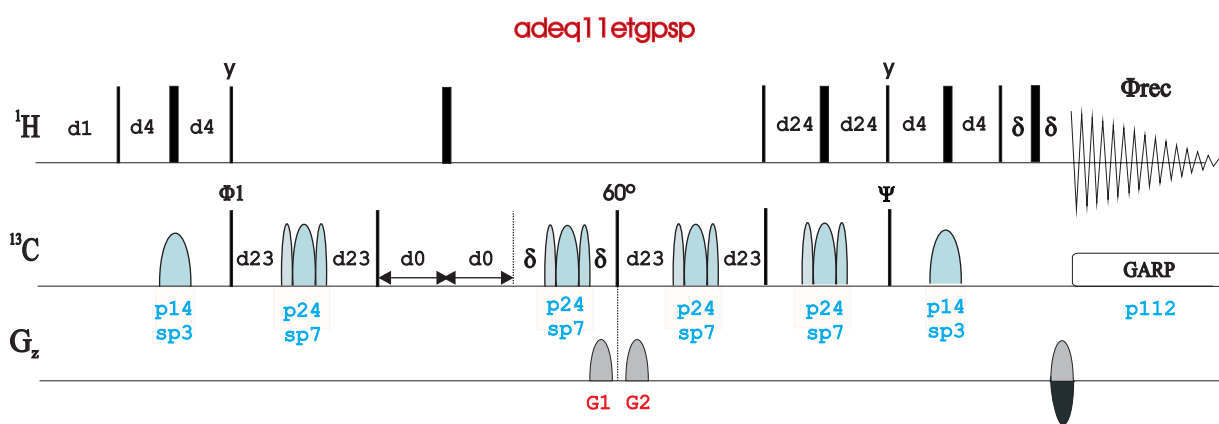
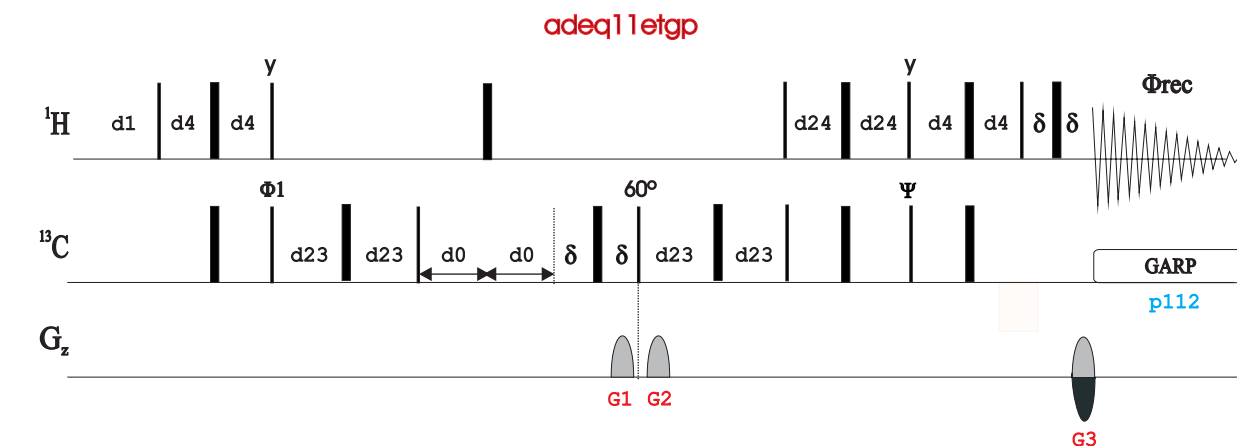

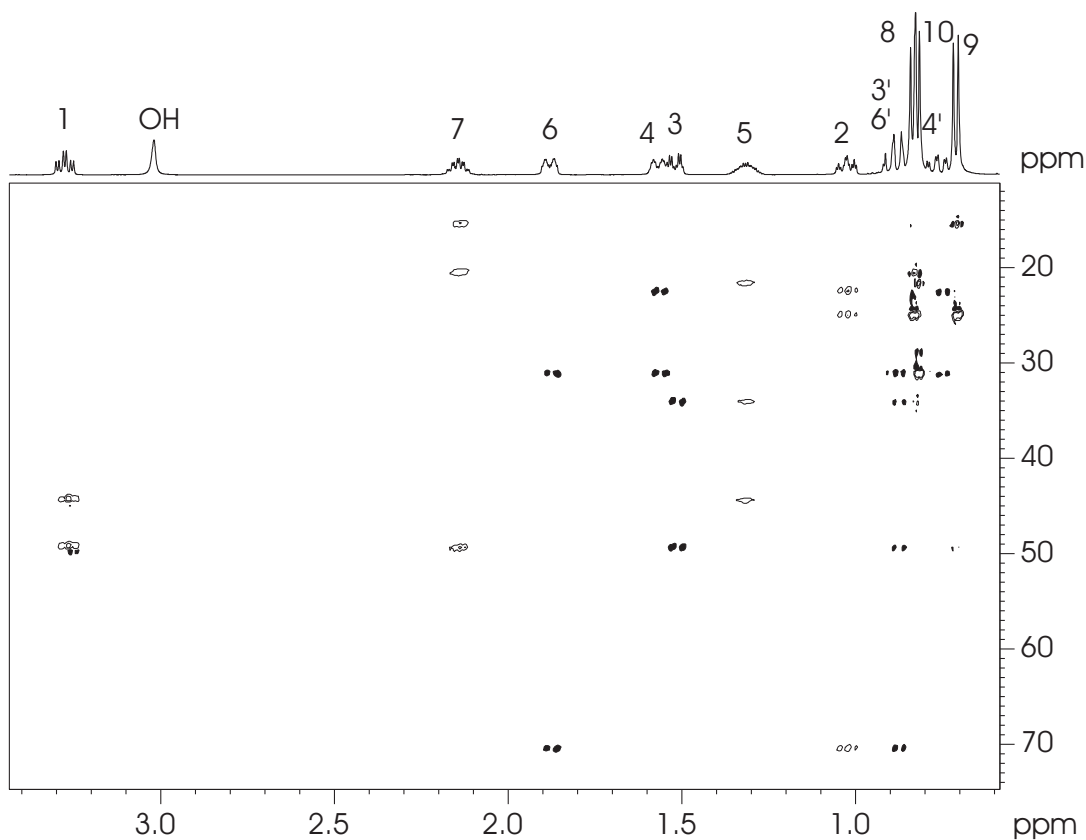
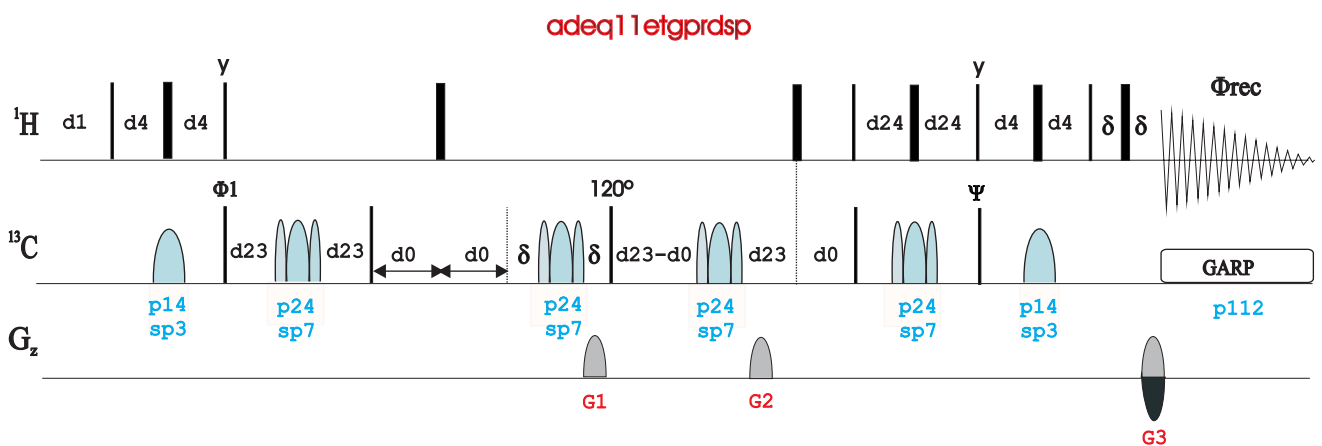
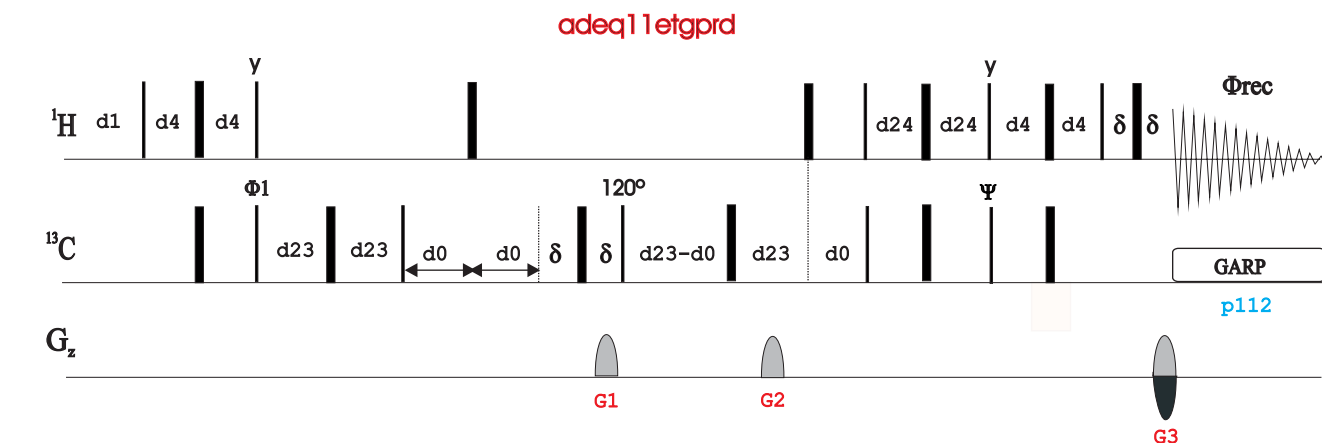

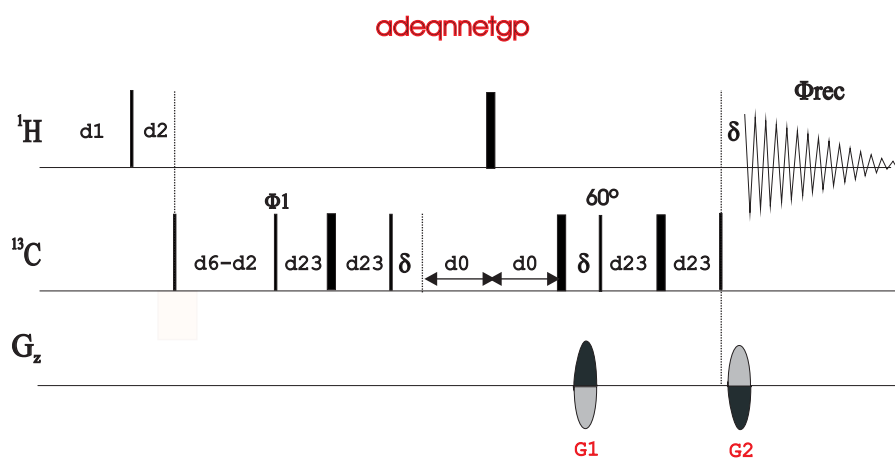
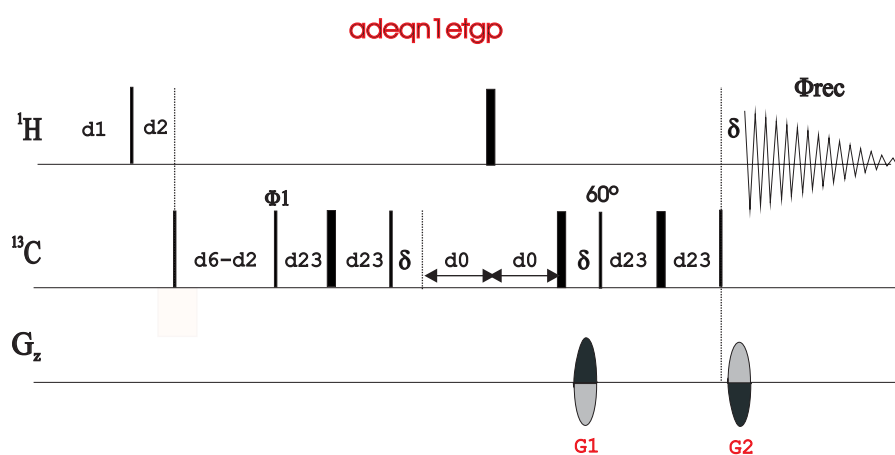
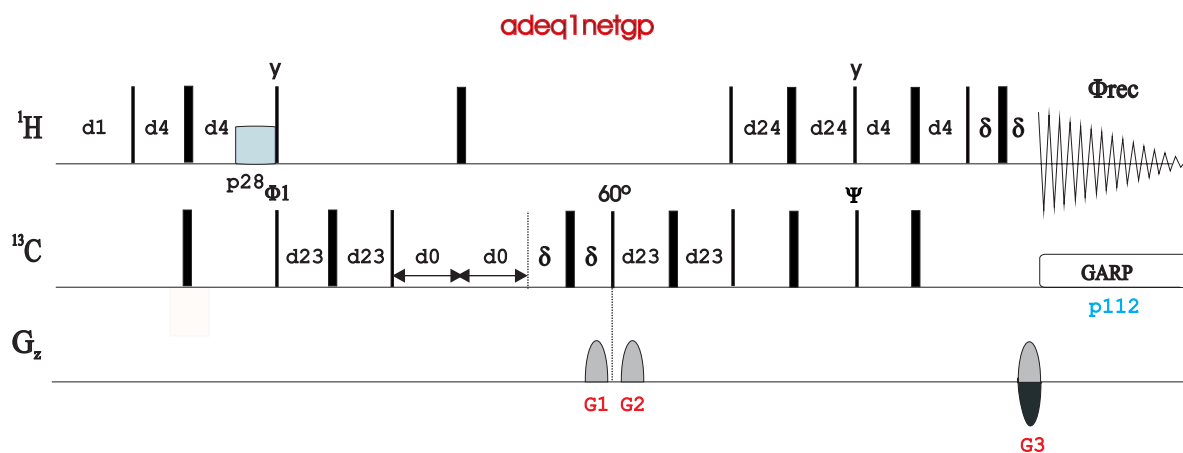

BRUKER PULSE PROGRAM CATALOGUE

NMRGuide

DIFFUSION/DOSY
EXPERIMENTS

Conventional 1D:

1D Stimulated Echo experiment (STE) (**stegp1s1d**)
1D Stimulated Echo experiment using bipolar gradients (**stebpgp1s1d**)
1D LED experiment (**ledgp2s1d**)
1D LED experiment using bipolar gradients (**ledbpgp2s1d**)
1D Double-Stimulated Echo Experiment (DSTE) (**dstepg3s1d**)
1D Double-Stimulated Echo Experiment (DSTE) using bipolar gradients (**dstebpgp3s1d**)

1D Stimulated Echo experiment using bipolar gradients and WATERGATE (**stebpgp1s191d**)

1D STE-INEPT experiment (**stebpgpin1s1d**)

2D DOSY maps:

2D Stimulated Echo experiment (STE) (**stegp1s**)
2D Stimulated Echo experiment using bipolar gradients (**stebpgp1s**)

2D Double-Stimulated Echo Experiment (DSTE) (**dstepg3s**)
2D Double-Stimulated Echo Experiment (DSTE) using bipolar gradients (**dstebpgp3s**)
2D LED experiment (**ledgp2s**)
2D LED experiment using bipolar gradients (**ledbpgp2s**)

2D Stimulated Echo experiment using bipolar gradients and WATERGATE (**stebpgp1s19**)

2D STE-INEPT experiment (**stebpgpin1s**)

2D & 3D DOSY related experiments:

3D DOSY-COSY using LED with bipolar gradients (**ledbpgpco2s3d**)

2D DOSY-TOCSY with LED using bipolar gradients (**ledbpgpml2s2d**)
2D DOSY-TOCSY with LED using bipolar gradients and WATERGATE (**ledbpgpml2s192d**)

3D DOSY-TOCSY using LED with bipolar gradients (**ledbpgpml2s3d**)

3D DOSY-NOESY using LED with bipolar gradients (**ledbpgpno2s3d**)

step1s
step1s1d

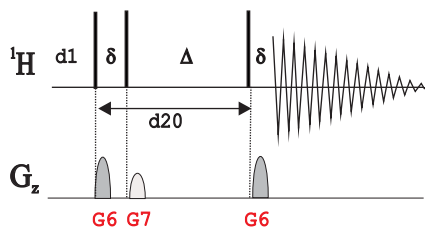

stebpgp1s
stebpgp1s1d

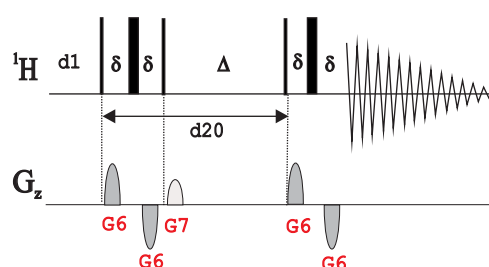

ledgp2s
ledgp2s1d

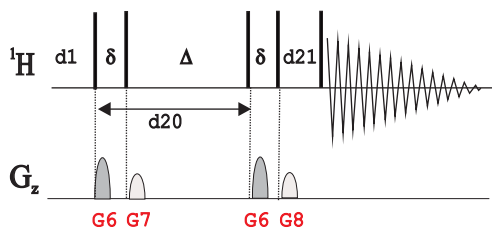

ledbpgp2s
ledbpgp2s1d

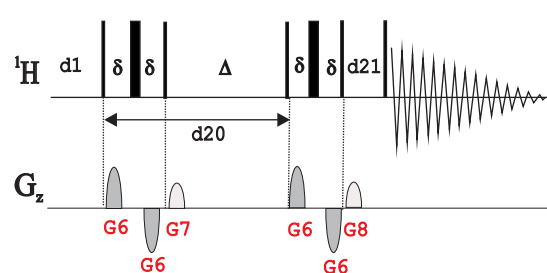

dstepg3s
dstepg3s1d

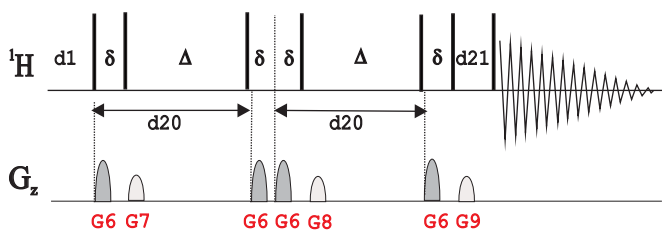

dstebpgp3s
dstebpgp3s1d

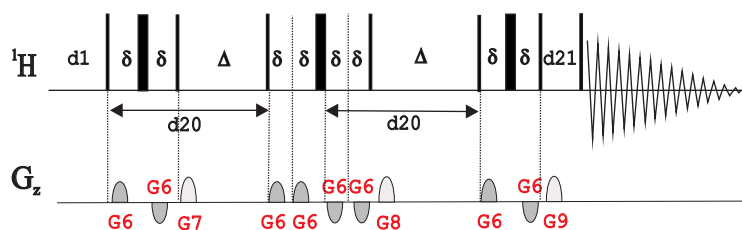

$$I = I_0 \exp(-D\gamma^2 g^2 \delta^2 (\Delta - \delta/3))$$

Peak intensity → I
 Initial Peak intensity → I_0
 Gyromagnetic Constant → γ
 Diffusion Coefficient → D
 Applied Gradient → $g = G_{\max} * gpz6$
 Diffusion Time (d20) → Δ
 Gradient Duration (p30) → δ

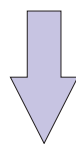

$$\ln(I/I_0) = -D\gamma^2 g^2 \delta^2 (\Delta - \delta/3)$$

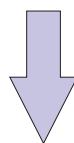

Stokes-Einstein Equation

$$D = KT / 6\pi\eta R_H$$

Diffusion Coefficient → D
 Boltzmann Constant → K
 Temperature → T
 Viscosity → η
 Hydrodynamic radius → R_H

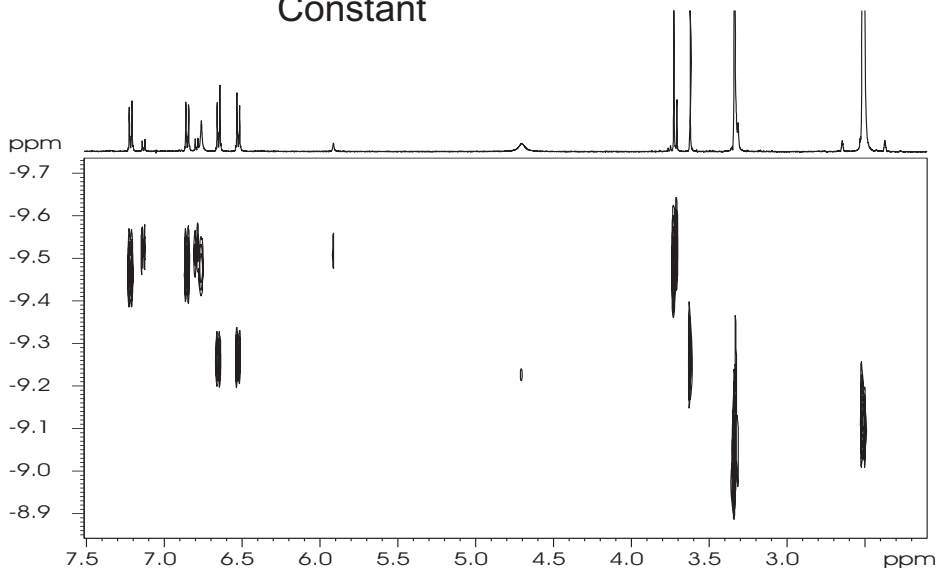

stebpgp1s19
stebpgp1s191d

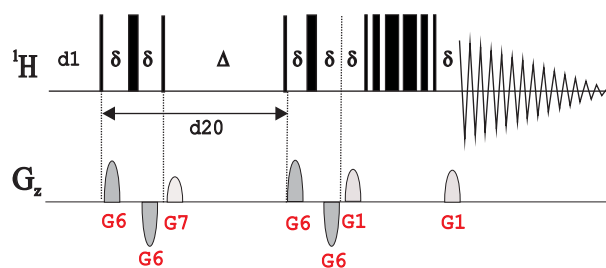

stebpgpin1s1d
stebpgpin1s

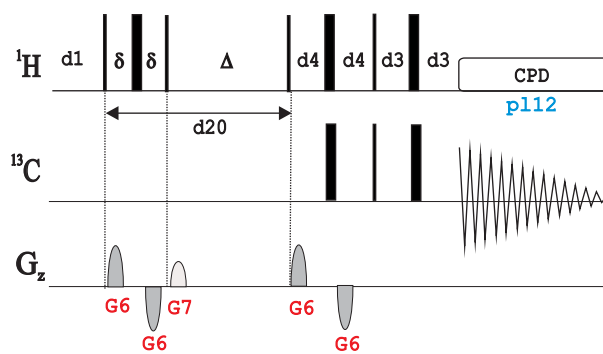

ledbpgpco2s3d

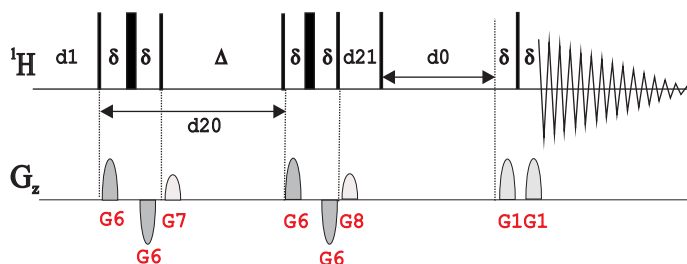

ledbpgpml2s3d

ledbpgpml2s2d

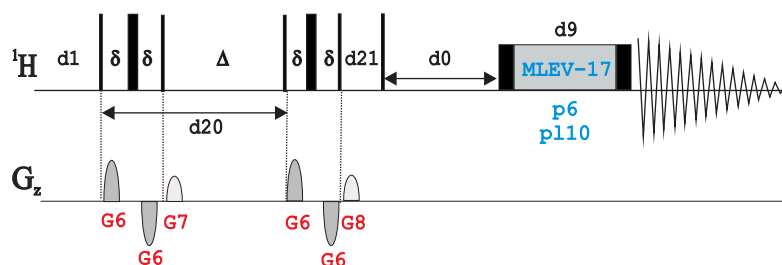

ledbpgpml2s192d

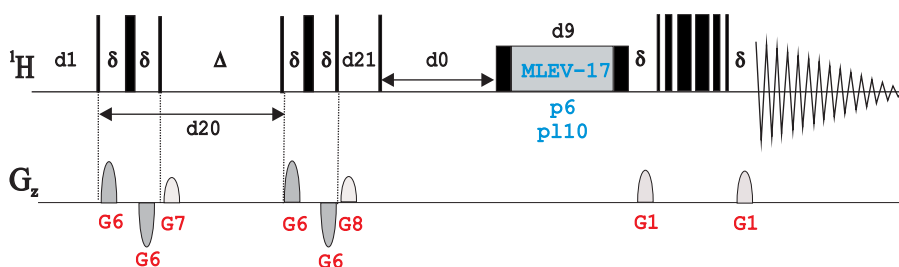

ledbpgpno3s3d

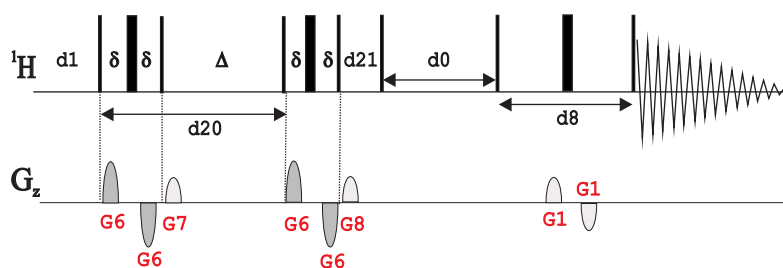

BRUKER PULSE PROGRAM CATALOGUE

NMRGuide

1D & 2D SATURATION TRANSFER
DIFFERENCE (STD) EXPERIMENTS

• **1D STD:**

1D STD (**stddiff**)
1D STD with spoil (**stddiff.2**)
1D STD with spoil and T2 filter (**stddiff.3**)

• **1D STD with solvent suppression:**

1D STD using 3-9-19 WATERGATE (**stddiffgp19**)
1D STD with spoil using 3-9-19 WATERGATE (**stddiffgp19.2**)
1D STD with spoil and T2 filter using 3-9-19 WATERGATE (**stddiffgp19.3**)
1D STD using excitation sculpting (**stddiffesgp**)
1D STD with spoil using excitation sculpting (**stddiffesgp.2**)
1D STD with spoil and T2 filter using excitation sculpting (**stddiffesgp.3**)

• **2D STD-TOCSY:**

2D STD-TOCSY (**stdmlevph**)
2D STD-TOCSY using 3-9-19 WATERGATE (**stdmlevgpph19**)
2D STD-TOCSY using excitation sculpting (**stdmlevesgpph**)

• **2D STD-NOESY:**

2D STD-NOESY with T2 filter in F2 (**stdnoesygpph**)
2D STD-NOESY with T2 filter in F1 and F2 (**stdnoesygpph.2**)
2D STD-NOESY using 3-9-19 WATERGATE with T2 filter in F2 (**stdnoesygpph19**)
2D STD-NOESY using 3-9-19 WATERGATE with T2 filter in F1 and F2 (**stdnoesygpph19.2**)
2D STD-NOESY using excitation sculpting with T2 filter in F2 (**stdnoesyegpph**)
2D STD-NOESY using excitation sculpting with T2 filter in F1 and F2 (**stdnoesyegpph.2**)

• **2D STD-HSQC:**

2D STD-HSQC using echo-antiecho (**stdhsqcetgppsp**)
2D STD-HSQC with sensitivity-improvement (**stdhsqcetgppsisp**)

stddiff

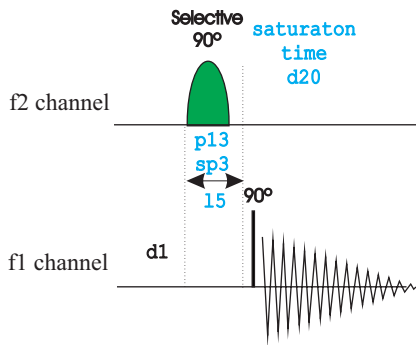

stddiff.2

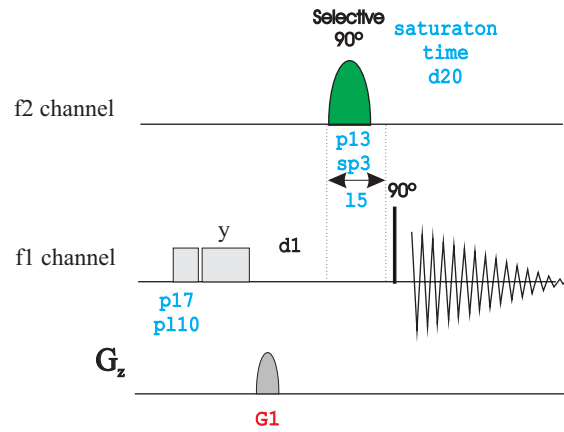

stddiff.3

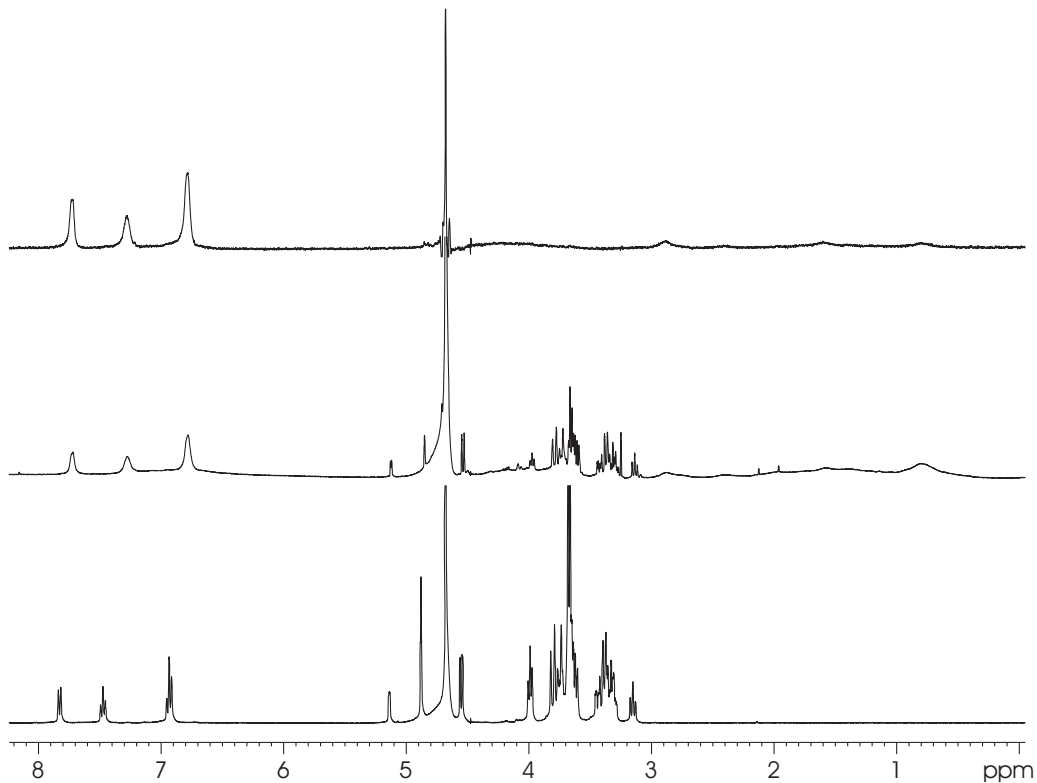
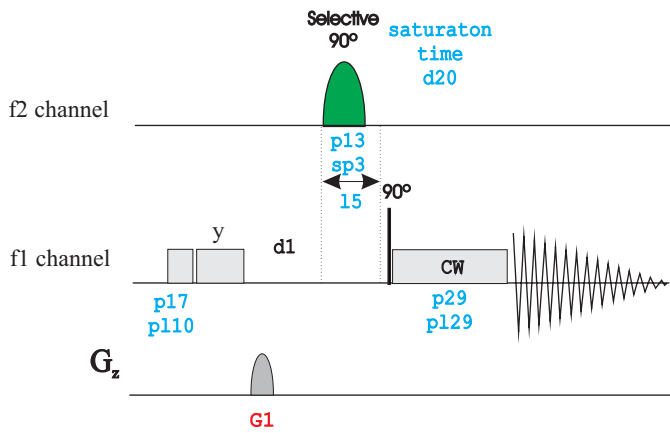

stdlffgp19

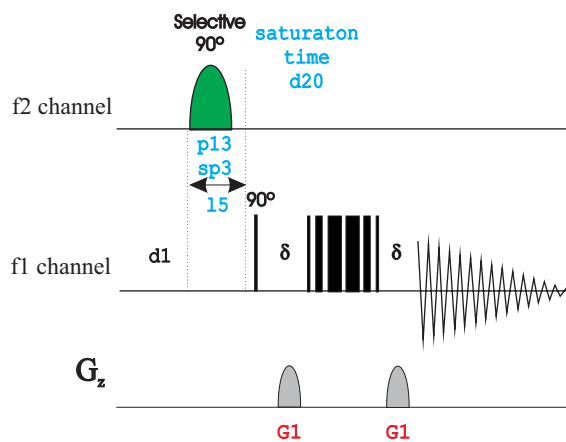

stdlffgp19.2

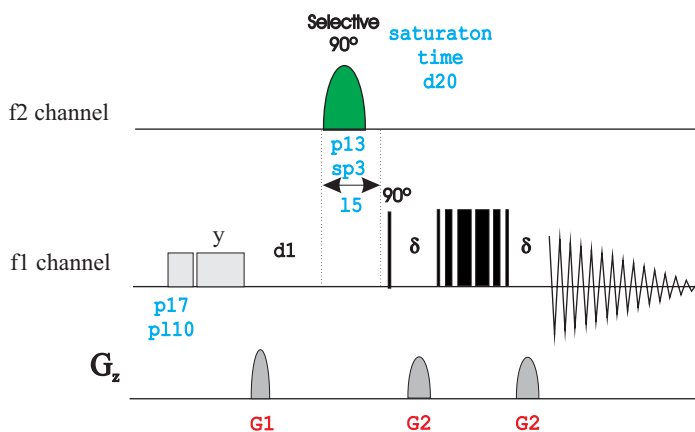

stdlffgp19.3

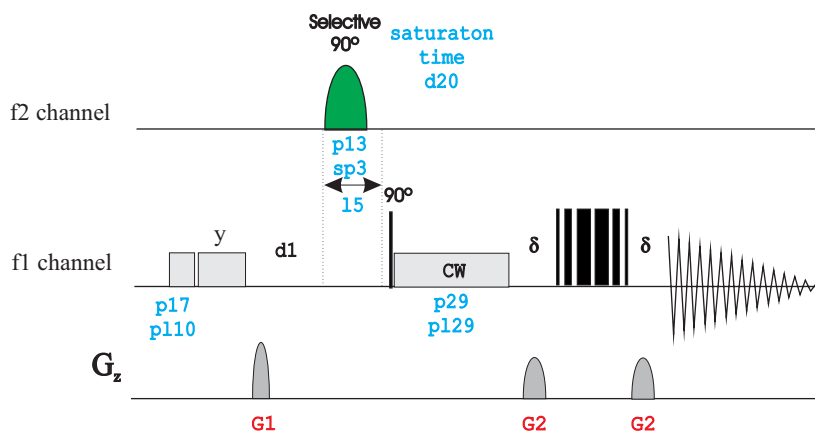

stdlffesgp

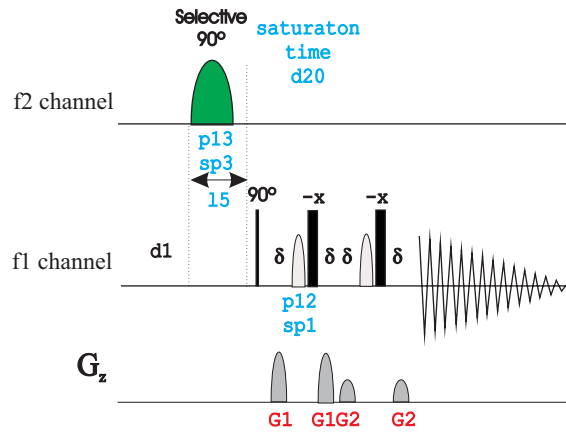

stdlffesgp.2

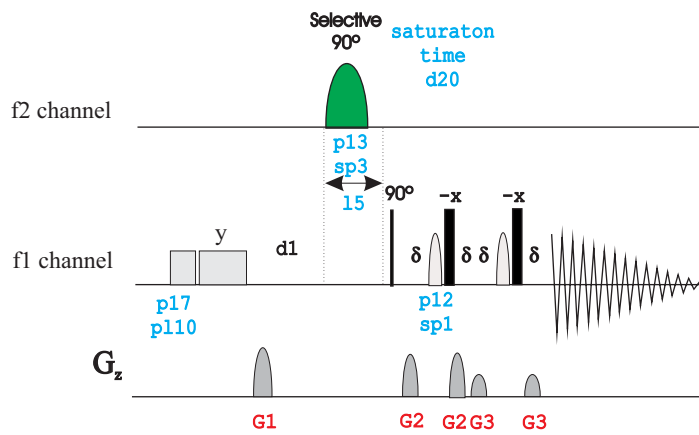

stdlffesgp.3

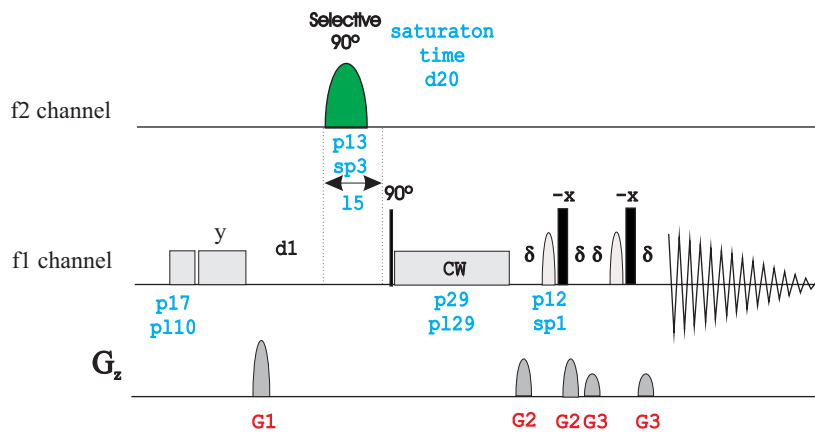

stdnoesygpph

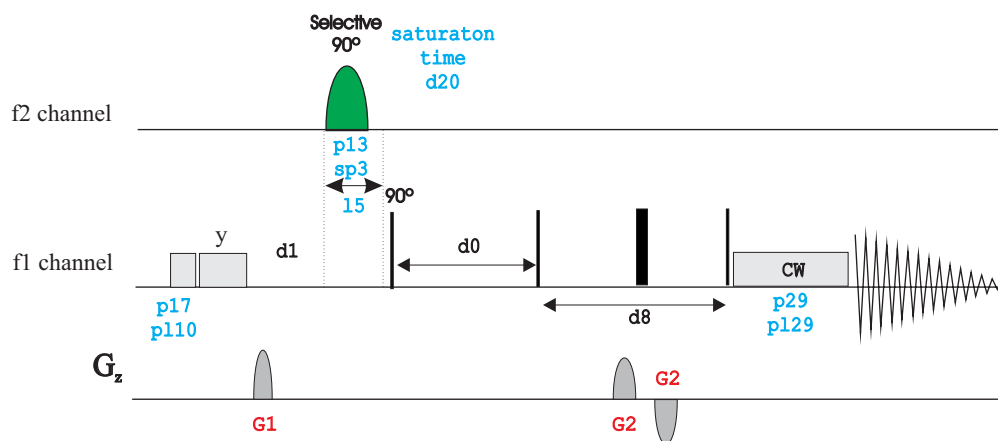

stdnoesygpph.2

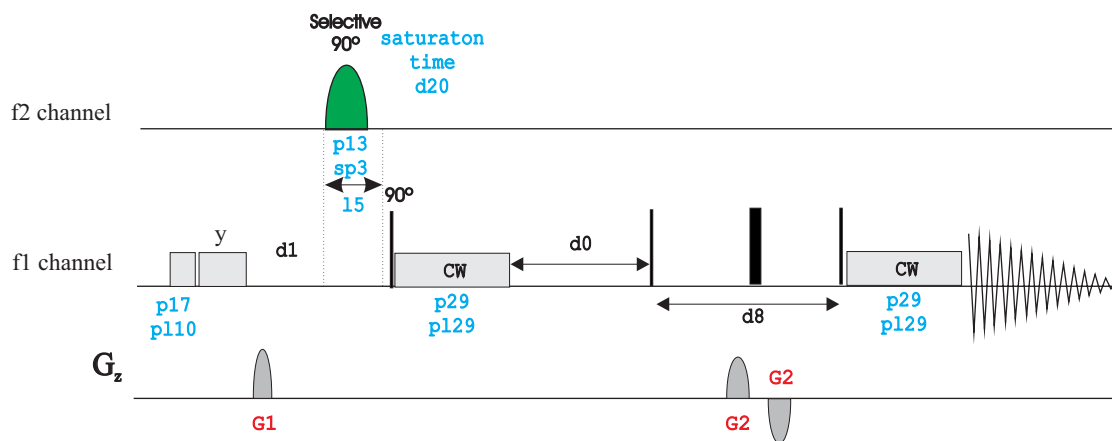

stdnoesygpph19

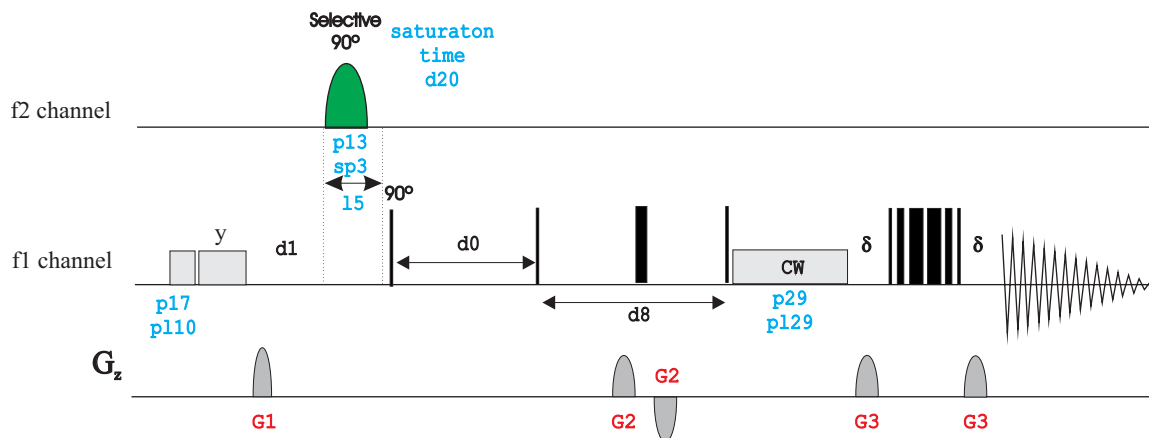

stdnoesygpph19.2

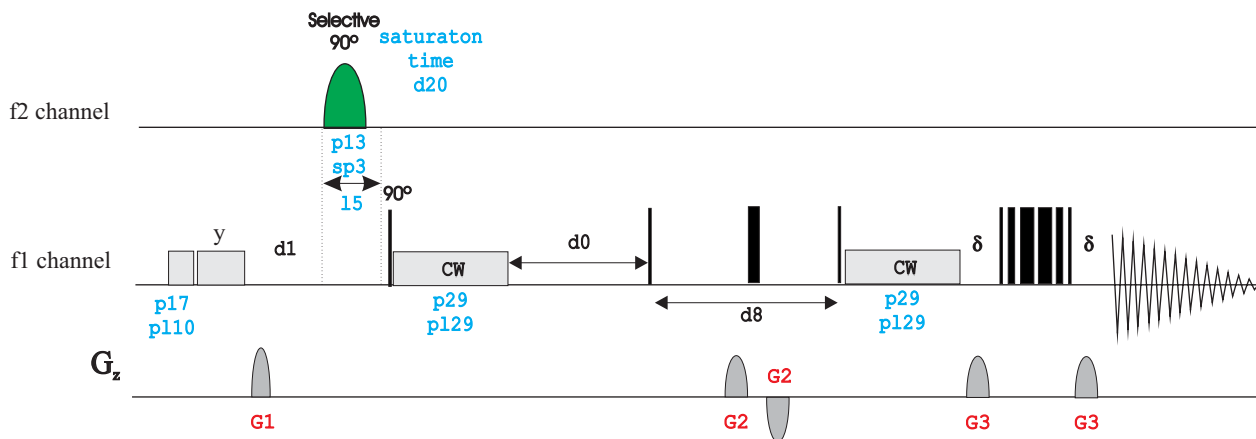

stdnoesyegpph

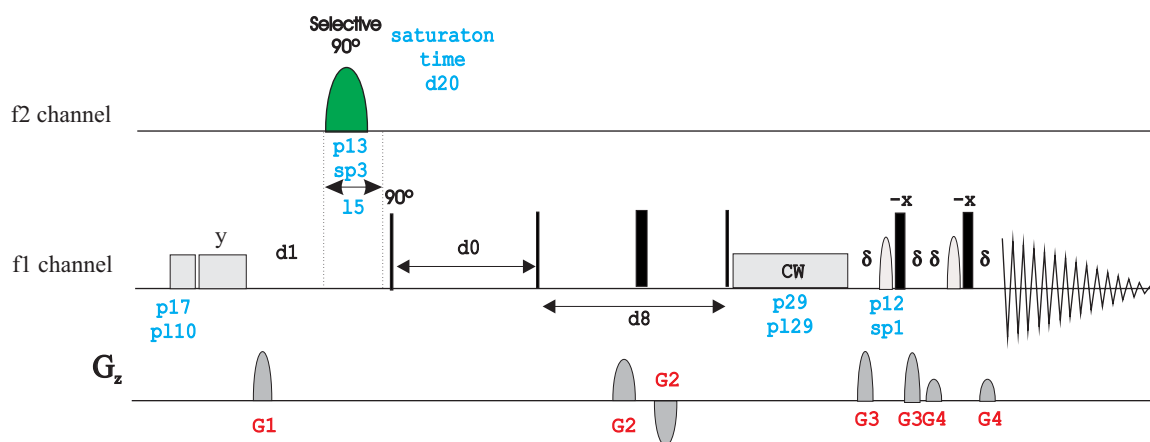

stdnoesyegpph.2

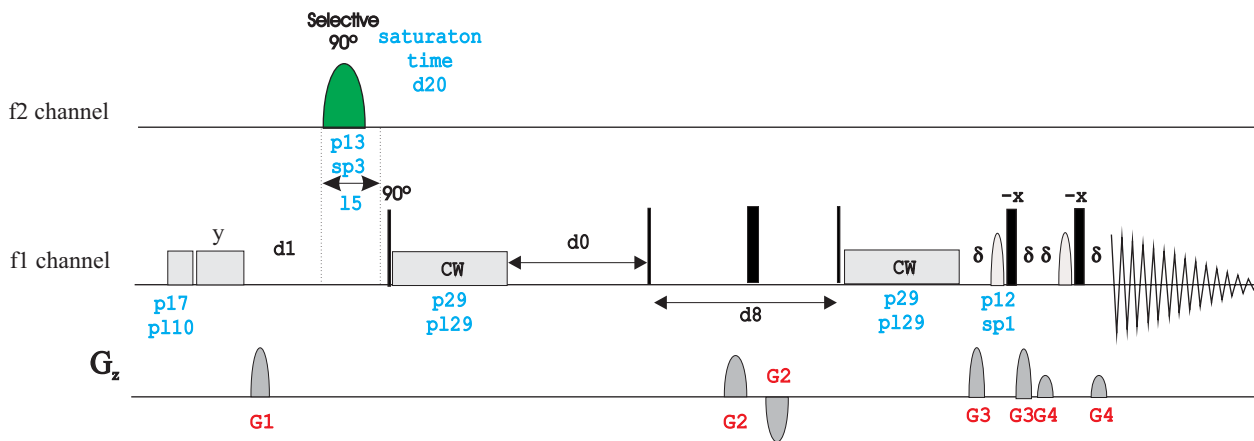

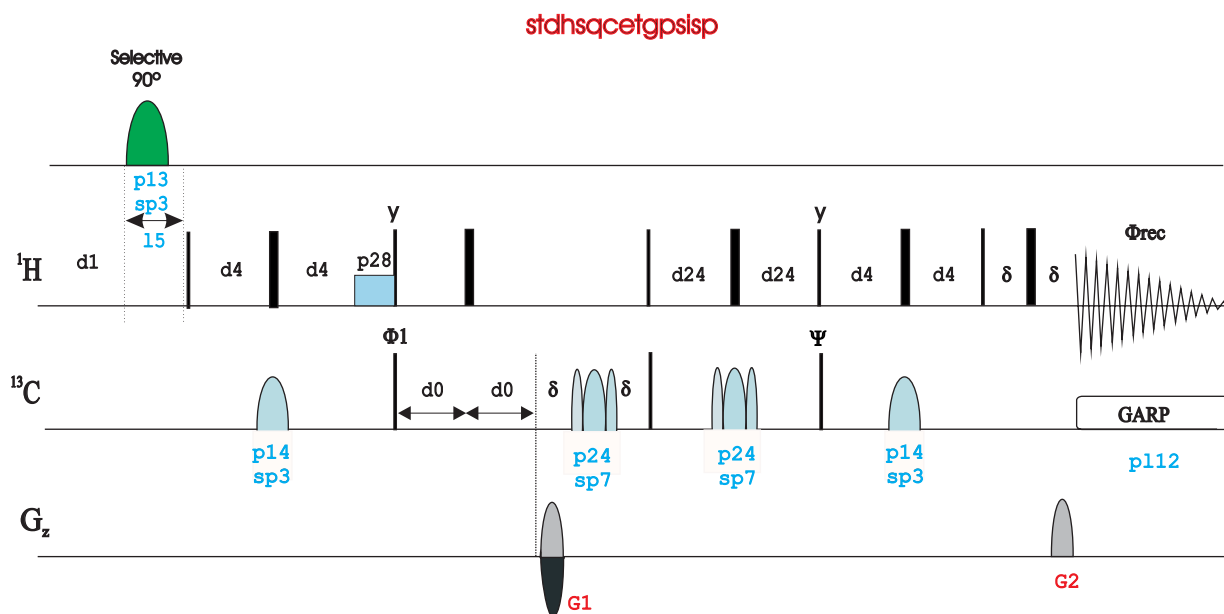
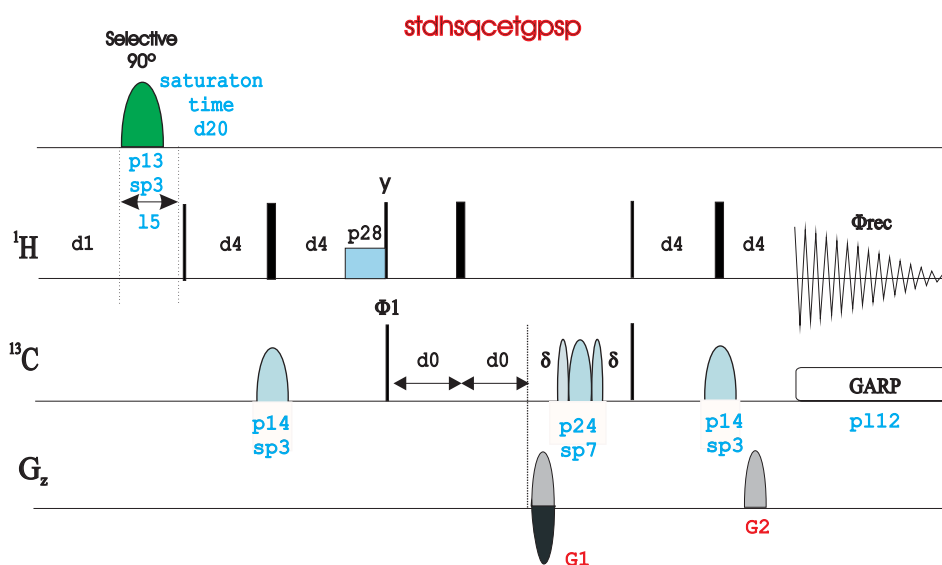

BRUKER PULSE PROGRAM CATALOGUE

NMRGuide

CLEANEX EXPERIMENTS

1D CLEANEX using 3-9-19 WATERGATE (**zgcxgp19**)
 1D CLEANEX using excitation sculpting (**zgcxesgp**)
 2D CLEANEX-Fast HSQC using 3-9-19 WATERGATE (**fhsqccxf3gp**)
 2D CLEANEX-TROSY using 3-9-19 WATERGATE (**troscxf3gp**)

zgcxgp19

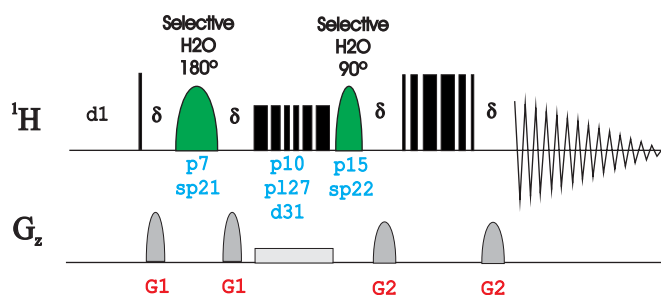

zgcxesgp

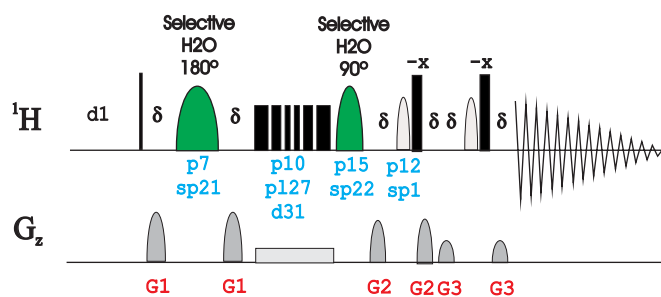

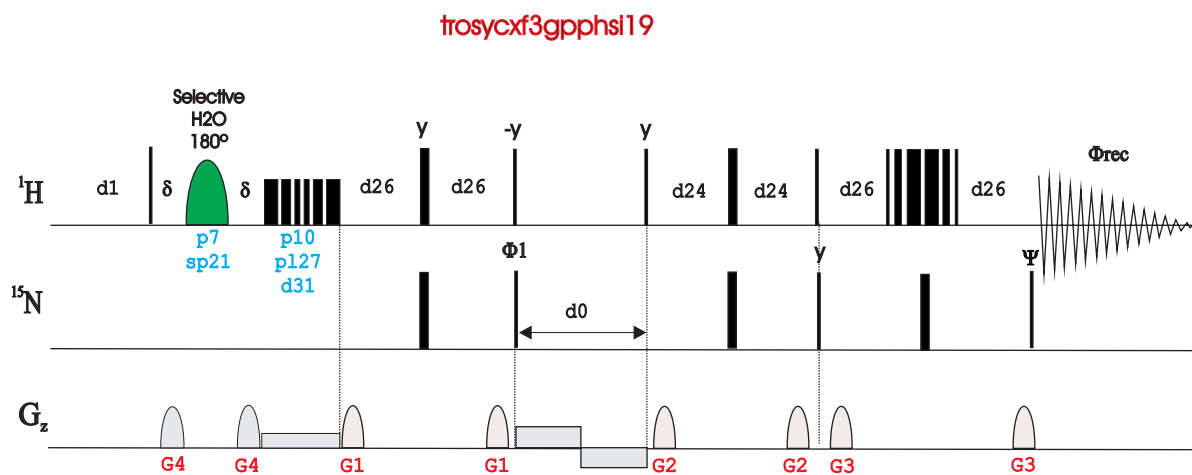
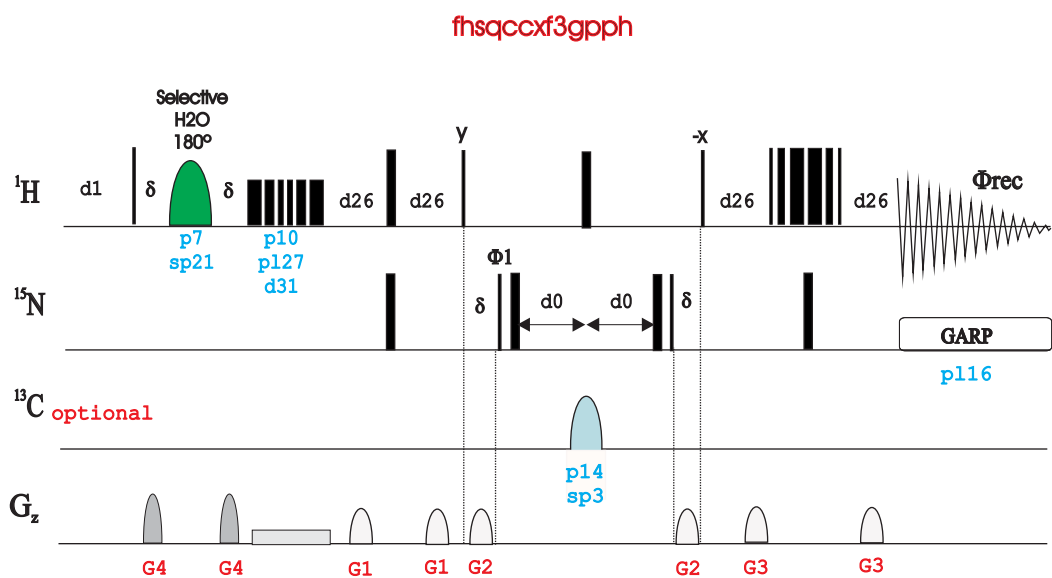

BRUKER PULSE PROGRAM CATALOGUE

NMRGuide

LC-NMR EXPERIMENTS

1D ¹H spectrum

- 1D ¹H with double presaturation (**lc1prf2** | LC1D12)
- 1D ¹H with triple presaturation (**lc1prft**)
- 1D ¹H with WET (**wet**)
- 1D ¹H with WET and CW decoupling on f2 during WET and ACQ (**wetdc** | LC1DWTDC)
- 1D ¹H with WET and CW decoupling on f2 during WET (**wetdw**)
- 1D ¹H WET solvent suppression with shape pulse and C-13 decoupling on f2 during WET and AQ for LC isocratic runs (**lc2wetdc**)
- 1D ¹H WET solvent suppression with shape pulse and C-13 decoupling on f2 during WET and AQ with intermediate preparation scan into second dataset for LC gradient runs with updated shapes (**lc2wetdcus** | LC2DWTUS)

1D NOESY

- 1D NOESY with presaturation (**noesypr1d**)
- 1D NOESY with presaturation and CW decoupling on f2 (**lc1pncw**)
- 1D NOESY with double presaturation and CW decoupling on f2 (**lc1pncwfd**)
- 1D NOESY with presaturation using shaped pulse and CW decoupling on f2 (**lc1pncwps**)
- 1D NOESY with double presaturation (**lc1pnf2**)
- 1D NOESY with multiple presaturation (**lc1pnfr**)
- 1D NOESY with triple presaturation (**lc1pnft**)
- 1D NOESY with presaturation using shaped pulse (**lc1pnps**)

Pseudo-2D-sequence

- Pseudo-2D-sequence for lc-nmr on flow detection (**lc2**)
- Pseudo-2D-sequence for lc-nmr on flow detection with power-gated decoupling (**lc2pg**)
- Pseudo-2D-sequence for lc-nmr on flow detection with presaturation (**lc2pn**)
- Pseudo-2D-sequence for lc-nmr on flow detection with double presaturation (**lc2pnf2**)
- Pseudo-2D-sequence for lc-nmr on flow detection with solvent gradients (**lc2pnf2ul**)
- Pseudo-2D-sequence for lc-nmr on flow detection with solvent gradients (**lc2pnpl**)
- Pseudo-2D-sequence for lc-nmr on flow detection (**lc2pnps**)
- Pseudo-2D-sequence for lc-nmr on flow detection with solvent gradients (**lc2pnul**)
- Pseudo-2D-sequence for lc-nmr on flow detection with presaturation (**lc2pr**)
- Pseudo-2D-sequence for lc-nmr on flow detection with double presaturation (**lc2prf2**)
- Pseudo-2D-sequence for lc-nmr on flow detection with presaturation using shape pulse (**lc2ps**)

2D homonuclear J-resolved

- 2D J-resolved with double presaturation and cw-decoupling on f2 (**lcjrescwfdprqf**)
- 2D J-resolved with presaturation and cw-decoupling on f2 (**lcjrescwprqf**)
- 2D J-resolved with presaturation using shape pulse and cw-decoupling on f2 (**lcjrescwpsqf**)
- 2D J-resolved with double presaturation (**lcjresf2prqf**)
- 2D J-resolved with presaturation (**lcjresprqf**)
- 2D J-resolved with presaturation using shape pulse (**lcjrespsqf**)

2D TOCSY

- 2D TOCSY with double presaturation and cw-decoupling on f2 (**lcmlcvcwfdpcph**)
- 2D TOCSY with presaturation and cw-decoupling on f2 (**lcmlcvcwpcphps**)
- 2D TOCSY with double presaturation using composite pulse (**lcmlcvf2pcph**)
- 2D TOCSY with double presaturation (**lcmlcvf2phpr** | LCML12)

- 2D TOCSY with presaturation using shape pulse and composite pulse (**lcmlevpcphps**)
- 2D TOCSY with presaturation using composite pulse (**lcmlevpcph**)

2D Experiments using WET

- 2D COSY using WET (**cosydcphwt** | COSYDCPHWT)
- 2D TOCSY using WET (**mlevdcphwt** | MLEVDCPHWT)
- 2D HSQC using WET (**hsqcetgpsiwt** | HQCETGPSIWT)

2D Experiments using single/multiple presaturation using shape pulse

- Phase-sensitive 2D COSY using using single/multiple presaturation (**cosycwphps** | COSYCWPHPS)
- Phase-sensitive 2D HSQC using using single/multiple presaturation (**hsqcphps**)
- 2D HMBC using using single/multiple presaturation (**hmbcndpsqf**)

Related experiments:

- Also see 1D Solvent suppression

lc2

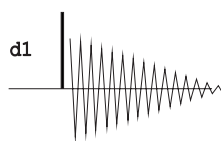

lc2pr

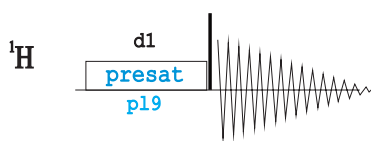

lc2ps

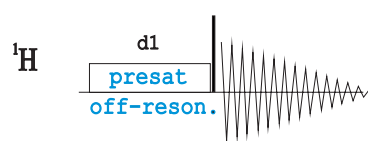

lc2pg

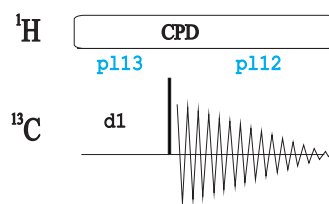

lc1prf2

lc2prf2

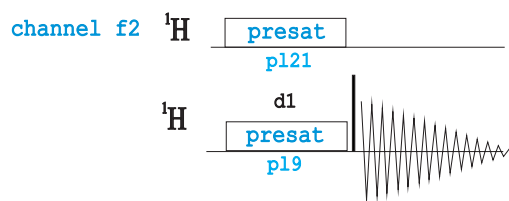

lc1prff

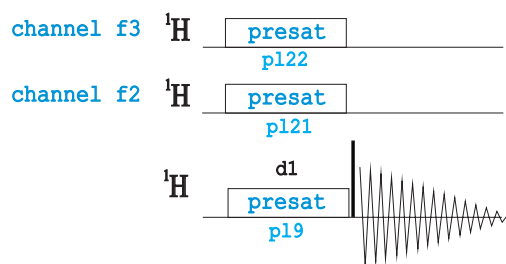

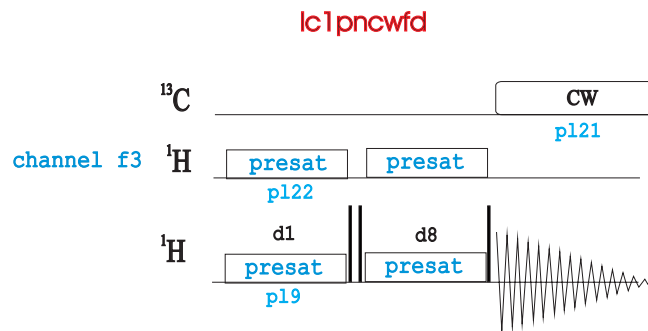
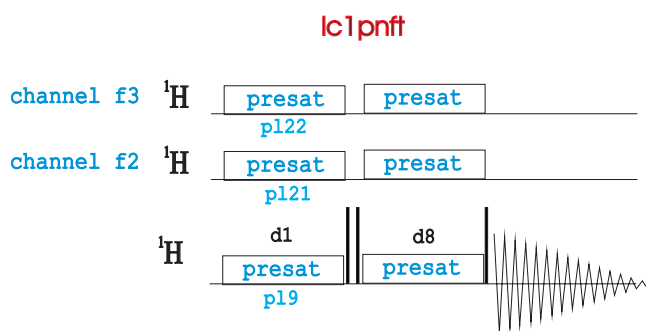
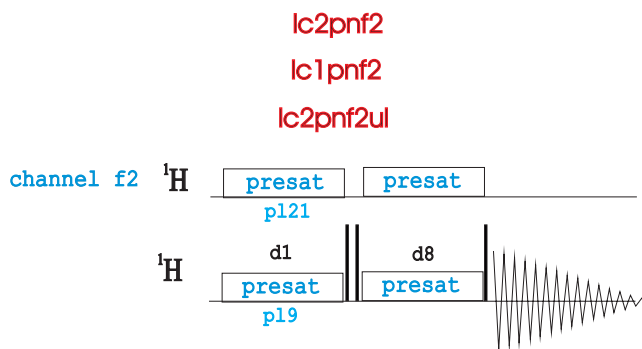
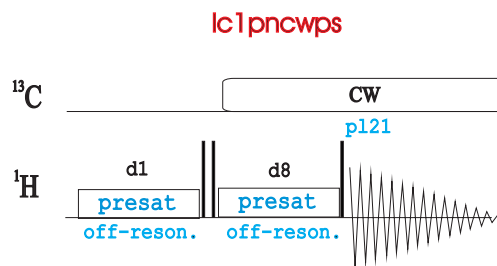
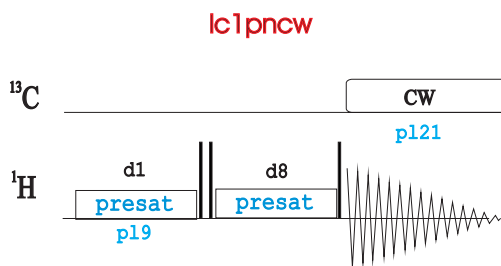
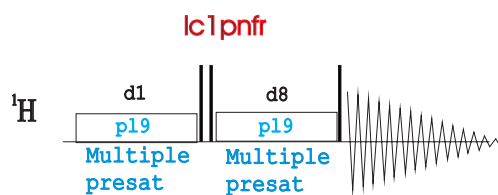
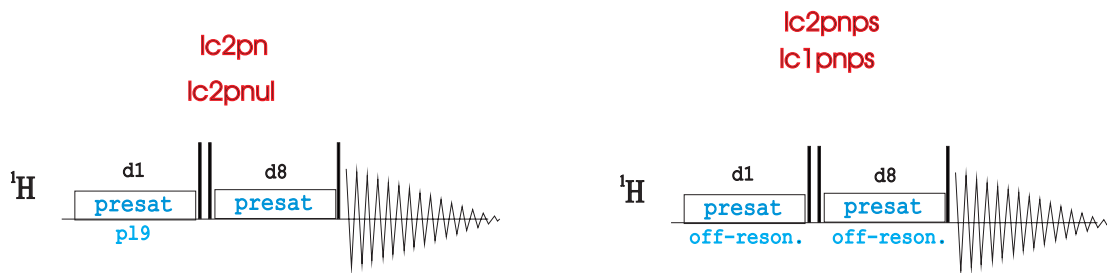

lcjrescwprqf

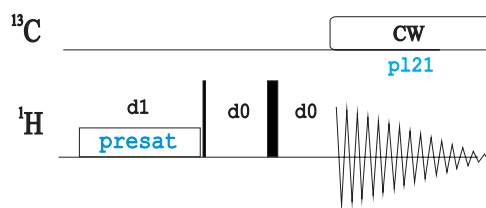

lcjrescwpsqf

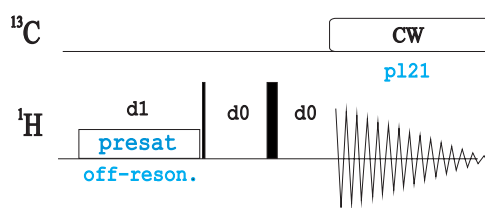

lcjresf2prqf

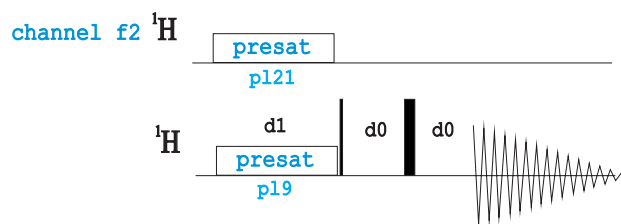

lcjrescwfdprqf

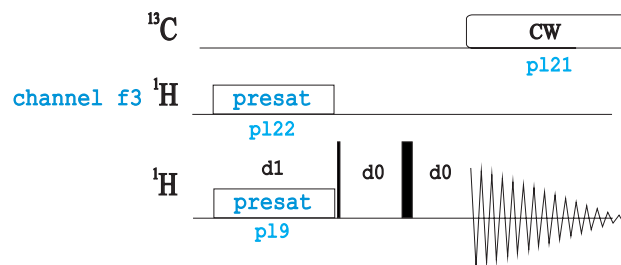

lcmlevpcph

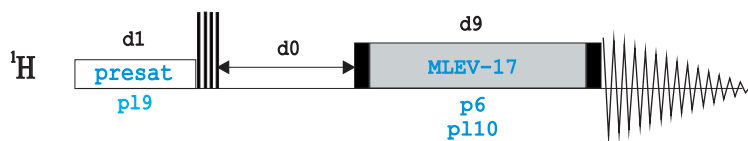

lcmlevpcphps

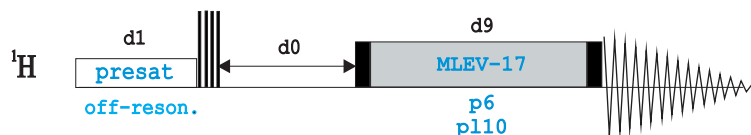

lcmlevf2phpr

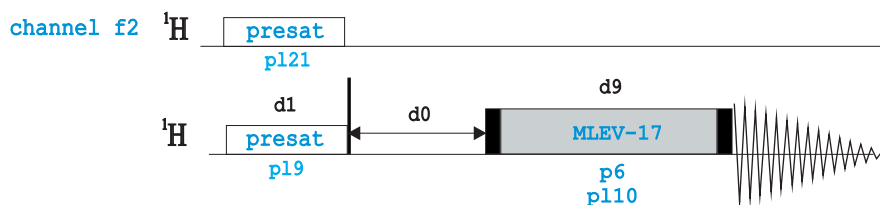

lcmlevf2pcph

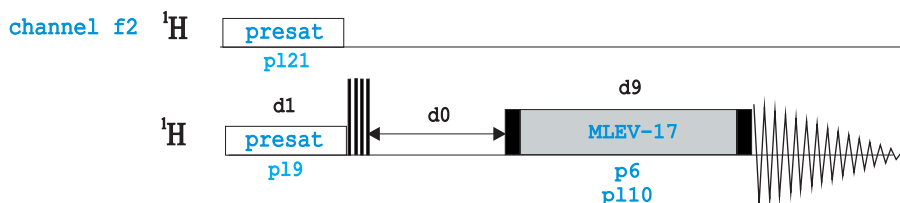

lcmlevcwpcphps

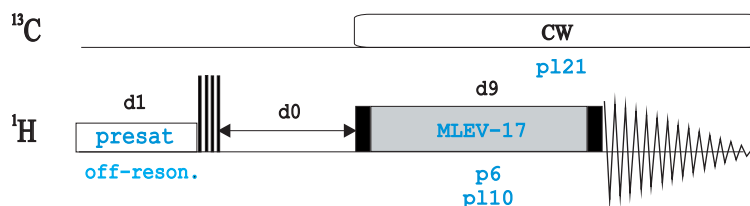

lcmlevcwfdpcph

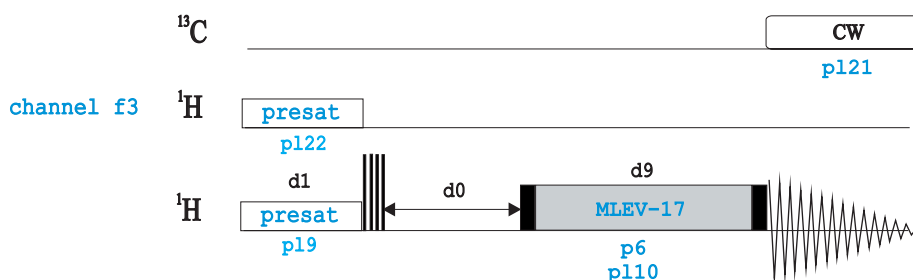

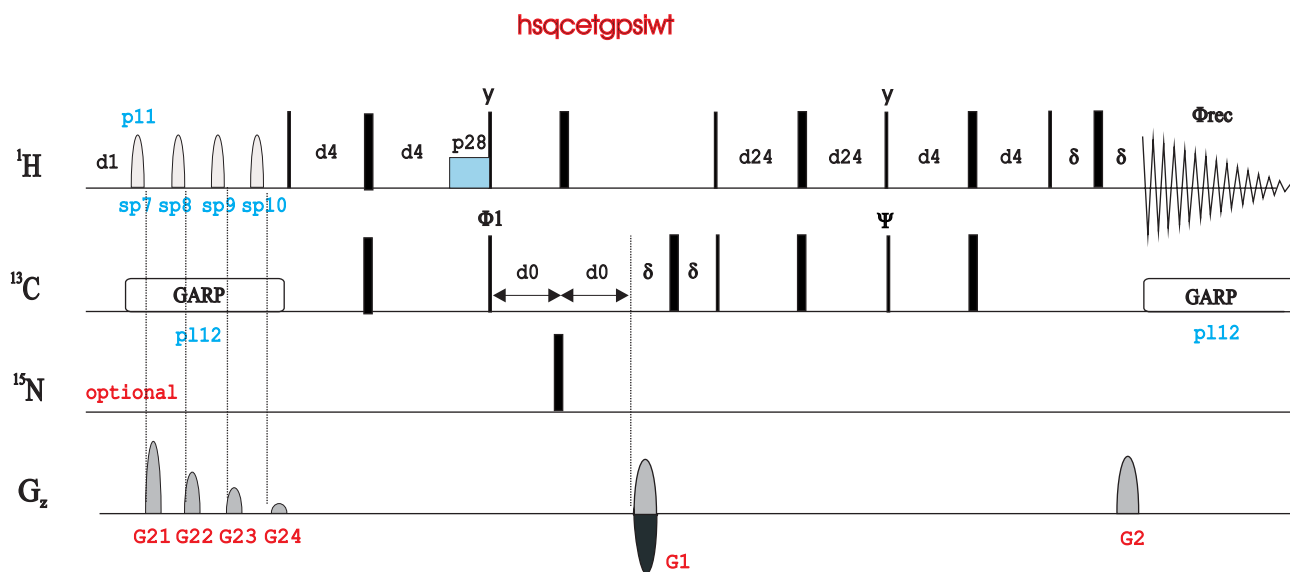
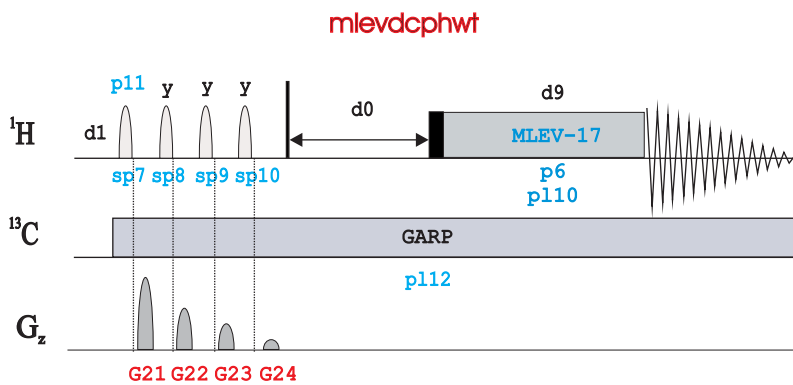
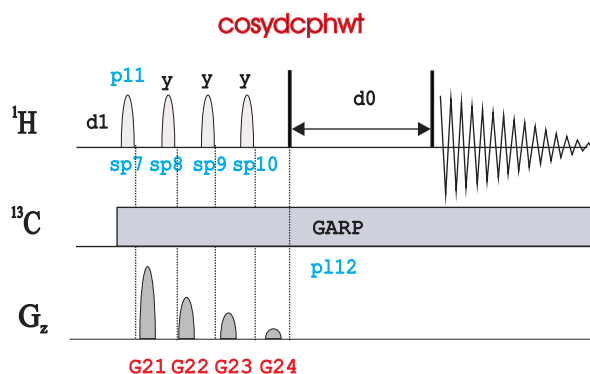

BRUKER PULSE PROGRAM CATALOGUE

NMRGuide

BASIC SOLID-STATE
NMR EXPERIMENTS

1D one-pulse High power decoupling (**hpdec**)
 1D CP (**cp**)
 1D CP (**cpnqs**)
 1D Sideband suppression with SELTICS (**cpseltics**)
 1D CPMAS with total sideband suppression using TOSS (**cptossa**)
 1D CPMAS with total sideband suppression using TOSS (**cptossb**)

hpdec

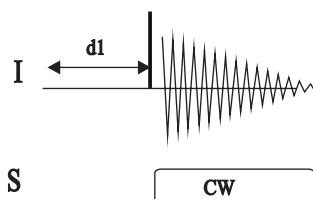

cp

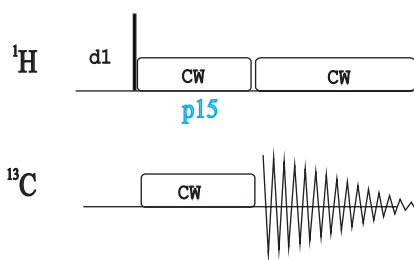

cpnqs

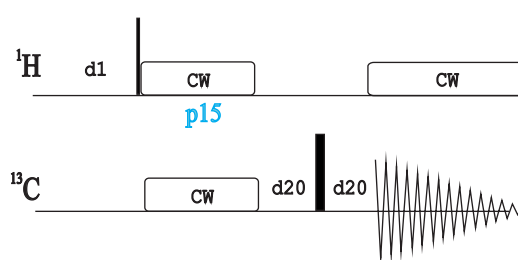

cpseltics

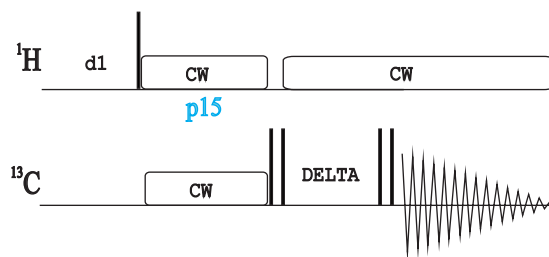

cptossb

cptossa

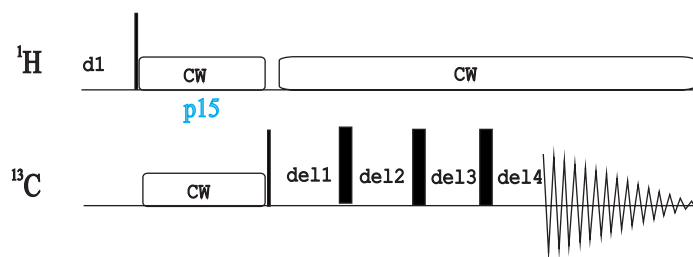

BRUKER PULSE PROGRAM CATALOGUE

NMRGuide

APPENDIX

```
;Pulprog.info
;avance-version (05/05/02)
;
;$CLASS=HighRes Info
;$COMMENT=

;For a pulseprogram the first characters (usually up to 6, but
;sometimes more) specify the type of experiment, e.g. DEPT, COSY,
;NOESY etc.. Further properties of the pulseprogram are
;indicated by a two-character code, which is added to the name
;in alphabetical order. For 2D experiments the mode (absolute value,
;phase sensitive or echo-antischo) is always indicated. H- or X-
;decoupling is assumed to be default for heteronuclear experiments,
;but not for homonuclear ones (except inad).
;In case of redundant information some two-character codes may be
;omitted.
;
;The two-character codes used are the following:

;ar      experiment for aromatic residues
;at      adiabatic TOCSY
;bi      with bird pulse for homonuclear J-decoupling
;bp      using bipolar gradients
;cc      cross correlation experiment
;cp      with composite pulse
;ct      constant time
;cw      decoupling using cw command
;cx      using CLEANEX_PM
;dc      decoupling using cpd command
;df      double quantum filter
;di      with DIPSI mixing sequence
;dh      homonuclear decoupling in indirect dimension
;dw      decoupling using cpd command only during wet sequence
;dq      double quantum coherence
;ea      phase sensitive using Echo/Antiecho method
;ec      with E.COSY transfer
;ed      with multiplicity editing
;es      excitation sculpting
;et      phase sensitive using Echo/Antiecho-TPPI method
;fb      using f2 - and f3 - channel
;fd      using f1 - and f3 - channel (for presaturation)
;fr      with presaturation using a frequency list
;ft      using f1 -, f2 - and f3 - channel (for presaturation)
;fh      F-19 observe with H-1 decoupling
;fp      using a flip-back pulse
;fl      for F-19 ecoupler
;f2      using f2 - channel (for presaturation)
;f3      using f3 - instead of f2 - channel
;f4      using f4 - instead of f2 - channel
;gd      gated decoupling using cpd command
;ge      gradient echo experiment
;gp      using gradients with ":gp" syntax
;gr      using gradients
;gs      using shaped gradients
;hb      hydrogen bond experiment
;hc      homodecoupling of a region using a cpd-sequence
;hd      homodecoupling
;hf      H-1 observe with F-19 decoupling
;hs      with homospoil pulse
;ia      InPhase-AntiPhase (IPAP) experiment
;ig      inverse gated
;ii      using inverse (invi/HSQC) sequence
;im      with incremented mixing time
;i4      using inverse (inv4/HMQC) sequence
;jc      for determination of J coupling constant
;jd      homonuclear J-decoupled
;jr      with jump-return pulse
;lp      with low-pass J-filter
;lq      with Q-switching (low Q)
;lr      for long-range couplings
;l2      with two-fold low-pass J-filter
;mf      multiple quantum filter
;m1      with MLEV mixing sequence
```



```
/mq      using multiple quantum
/nd      no decoupling
/no      with NOESY mixing sequence
/pc      with presaturation and composite pulse
/pg      power-gated
/ph      phase sensitive using States-TPPI, TPPI, States or QSEC
/pl      preparing a frequency list
/pn      with presaturation using a 1D NOESY sequence
/pp      using purge pulses
/pr      with presaturation
/ps      with presaturation using a shaped pulse
/qf      absolute value mode
/qn      for QNP-operation
/qs      phase sensitive using qseq-mode
/rd      refocussed
/rl      with relay transfer
/rs      with radiation damping suppression using gradients
/ru      using radiation damping compensation unit
/rv      with random variation
/r2      with 2 step relay transfer
/r3      with 3 step relay transfer
/se      spin echo experiment
/sh      phase sensitive using States et al. method
/si      sensitivity improved
/sm      simultaneous evolution of X and Y chemical shift
/sp      using a shaped pulse
/sq      using single quantum
/ss      spin-state selective experiment
/st      phase sensitive using States-TPPI method
/sy      symmetric sequence
/s3      S3E experiment
/xf      x-filter experiments
/xy      with XY CPMG sequence
/x1      x-filter in F1
/x2      x-filter in F2
/x3      x-filter in F3
/zf      with z-filter
/zq      zero quantum coherence
/zs      using a gradient/rf spoil pulse
/1d      1D version
/1s      using 1 spoil gradients
/11      using 1-1 pulse
/19      using 3-9-19 pulse
/2h      using 2H lockswitch unit
/2s      using 2 spoil gradients
/3d      3D sequence
/3s      using 3 spoil gradients
/30      using a 30 degree flip angle
/45      using a 45 degree flip angle
/90      using a 90 degree flip angle
/135     using a 135 degree flip angle

;Typical experiment names would be:
;  cosy, dept, dipsi2, hmbc, hmqc, hoesy, hsqc, inad, inept,
;  mlev, noesy, roesy or trosy.

;Inverse correlations are denoted as hmbc, hmqc or hsqc.
;  Experiments with a BIRD sequence in the beginning
;  also contain a bi in the name.

;1D experiments, which are analogues of 2D experiments by virtue of
;  a selective pulse, start with sel.
;Semiselective 2D experiments have the same name as the unselective
```

```
; version but with an s at the beginning:
;
; scosyph <-> cosyph.

;A phase-sensitive (States-TPPI, TPPI etc.) NOESY experiment with
; presaturation would then be:
;
;      noesy + ph + pr =   noesyphpr.

;In the other direction the pulseprogram hmbcgplpndqf would be
;
;      hmbc + gp + lp + nd + qf
;
;      and therefor an:
;
;      inverse correlation for long-range couplings (HMBC) with
;      coherence selection using gradients with ":gp" syntax,
;      low-pass J-filter,
;      no decoupling
;      in absolute value mode.

;The nomenclature of parameters is described in Pulprog.info.

;Comments like:
;
;      ;avance-version
;      ;begin ____
;      ;end ____
;
;      with (____ = MLEV17, DIPSI2, ...)
;
;are evaluated by NMRSIM for the pulseprogram display and should
;therefor not be removed. The syntax for begin/end statements allows
;characters, numbers and '_'. Arithmetic operators must not be used.
;
;
;The comments:
;
;      ;preprocessor-flags-start
;      ;preprocessor-flags-end
;
;are also evaluated to identify flags used in the pulseprogram and
;must also not be removed.

;$Id: $
```

```

;Param.info
;avance-version (05/10/24)
;
;The following convention is used for power levels, pulses, delays
;and loop counters throughout the microprograms:
;
; $CLASS=HighRes Info
; $COMMENT=

;p10 :
;p11 : f1 channel - power level for pulse (default) {all, PL90[F1]}
;p12 : f2 channel - power level for pulse (default) {all, PL90[F2]}
;p13 : f3 channel - power level for pulse (default) {all, PL90[F3]}
;p14 : f4 channel - power level for pulse (default) {all, PL90[F4]}
;p15 : f5 channel - power level for pulse (default) {}
;p16 : f6 channel - power level for pulse (default) {}
;p17 : f7 channel - power level for pulse (default) {}
;p18 : f8 channel - power level for pulse (default) {}
;p19 : f1 channel - power level for presaturation
{default+lcnmr+triple+triple2+triple_na, PLCW[F1]}
;p110: f1 channel - power level for TOCSY-spinlock {all, PLTOC[F1]}
;p111: f1 channel - power level for ROESY-spinlock {all, PLROE[F1]}
;p112: f2 channel - power level for CPD/BB decoupling {all, PLCPDP[F2]}
;p113: f2 channel - power level for second CPD/BB decoupling
{default+lcnmr+triple_c,
PLCPD2[F2]}
; or f2 channel - power level for Cbeta/CO decoupling {triple+triple2, PLSH13[F2]}
;p114: f2 channel - power level for cw saturation {default, PLNOE[F2]}
; or f2 channel - power level for cw saturation {triple+triple2, PLCW[F2]}
; or f2 channel - power level for low power decoupling {lcnmr, PLUSER1[F2]}
;p115: f2 channel - power level for TOCSY-spinlock {all, PLTOC[F2]}
;p116: f3 channel - power level for CPD/BB decoupling {all, PLCPDP[F3]}
;p117: f4 channel - power level for CPD/BB decoupling {all, PLCPDP[F4]}
;p118: f1 channel - power level for 3-9-19-pulse (watergate)
{default+lcnmr+triple+triple2+triple_na, PL90[F1]}
;p119: f1 channel - power level for CPD/BB decoupling
{default+lcnmr+triple+triple2+triple_na, PLCPDP[F1]}
;p120: f1 channel - power level for Dante-z pulse {}
; or f2 channel - power level for TOCSY-spinlock (higher sel.) {triple_na, PLUSER5[F2]}
;p121: f2 channel - power level for presaturation {default+lcnmr, PLCW[F2]}
;p122: f3 channel - power level for presaturation {lcnmr, PLCW[F3]}
; or f3 channel - power level for TOCSY-spinlock (higher sel.) {triple_na, PLUSER4[F3]}
;p123: f3 channel - power level for TOCSY-spinlock
{default+lcnmr+triple+triple_c, PLTOC[F3]}
; or f3 channel - power level for Rexchange spinlock {triple2, PLUSER2[F3]}
; or f3 channel - power level for TOCSY-spinlock {triple_na, PLUSER3[F3]}
;p124: f2 channel - power level for hd/hc decoupling {all, PLHD[F2]}
;p125: f1 channel - power level for TOCSY spinlock (higher sel.) {triple_na, PLUSER3[F1]}
; or f3 channel - power level for Tlrho spinlock {triple+triple2, PLUSER1[F3]}
;p126: f2 channel - power level for cw decoupling {lcnmr, PLCPDP[F2]-18}
; or f2 channel - power level for TOCSY spinlock (higher sel. II) {triple_na, PLUSER3[F2]}
;p127: f1 channel - power level for pulsed ROESY-spinlock {default, PLROE[F1]}
; or f1 channel - power level for cleanex spinlock {triple2, PLUSER1[F1]}
; or f2 channel - power level for TOCSY spinlock (higher sel. III) {triple_na, PLUSER4[F2]}
;p128: f2 channel - power level for selective Ca or CO decoupling {triple+triple2, PLSH10[F2]}
; or f2 channel - power level for selective decoupling {triple_na, PLSH6U[F2]}
;p129: f2 channel - power level for simultaneous Ca and CO decoupling {triple2, PLSH14[F2]}
;p130: f2 channel - power level for bilev decoupling
{default+triple+triple2+triple_na, PLCPDP[F2]}
;p131: f2 channel - power level for bilev decoupling
{default+triple+triple2+triple_na, PLUSER2[F2]}

;sp0 : f1 channel - shaped pulse 180 degree (adiabatic TOCSY) {}
; or f2 channel - shaped pulse 180 degree (two-fold modulated) {triple_na, PLSH7U[F2]}
;sp1 : f1 channel - shaped pulse for selective excitation {default, PLSH1[F1]}
; or f1 channel - shaped pulse for water flipback
{triple+triple2+triple_na, PLSH8[F1]}
;sp2 : f1 channel - shaped pulse 180 degree {default, PLSH2[F1]}
; or f2 channel - shaped pulse 90 degree (on resonance)
{triple+triple2,
PLSH4[F2]}
; or f2 channel - shaped pulse 90 degree (on resonance) {triple_na, PLSH1U[F2]}
;sp3 : f2 channel - shaped pulse 180 degree (adiabatic) {default, PLSH3[F2]}
; or f2 channel - shaped pulse 180 degree (on resonance) {triple+triple2,
PLSH6[F2]}

```

```

; or f2 channel - shaped pulse 180 degree (on resonance) {triple_na, PLSH3U[F2]}
;sp4 : f2 channel - shaped pulse 90 degree (off resonance) {triple+triple2,
PLSH4[F2]}
;sp5 : f2 channel - shaped pulse 180 degree (off resonance) {triple+triple2,
PLSH6[F2]}
; or f2 channel - shaped pulse 180 degree (off resonance) {triple_na, PLSH3U[F2]}
;sp6 : f1 channel - shaped pulse for presaturation
{default+lcnmr+triple+triple2+triple_na, PLSH7[F1]}
;sp7 : f1 channel - shaped pulse for wet {lcnmr, PLSH3[F1]+0.87}
; or f1 channel - shaped pulse 180 degree (adiabatic) {triple_c, PLSH13[F1]}
; or f2 channel - shaped pulse 180 degree (adiabatic) {default, PLSH2[F2]}
; or f2 channel - shaped pulse 180 degree (off resonance2) {triple+triple2,
PLSH6[F2]}
; or f2 channel - shaped pulse 180 degree (off resonance2) {triple_na, PLSH3U[F2]}
;sp8 : f1 channel - shaped pulse for wet {lcnmr, PLSH3[F1]-1.04}
; or f2 channel - shaped pulse 90 degree (on res., time reversed) {triple+triple2,
PLSH5[F2]}
; or f2 channel - shaped pulse 90 degree (on res., time reversed) {triple_na, PLSH2U[F2]}
;sp9 : f1 channel - shaped pulse for wet {lcnmr, PLSH3[F1]+2.27}
; or f2 channel - shaped pulse 180 degree (higher selectivity) {triple+triple2,
PLSH9[F2]}
; or f3 channel - shaped pulse 180 degree (on resonance) {triple_na, PLSH1U[F3]}
;sp10: f1 channel - shaped pulse for tilted ROESY {}
; or f1 channel - shaped pulse for wet {lcnmr, PLSH3[F1]-5.05}
; or f2 channel - shaped pulse 90 degree (higher selectivity) {triple+triple2,
PLSH7[F2]}
; or f2 channel - shaped pulse 90 degree (higher selectivity) {triple_na, PLSH4U[F2]}
;sp11: f1 channel - shaped pulse for wet2 {}
; or f1 channel - shaped pulse for water flipback {default, PLSH8[F1]}
; or f1 channel - shaped pulse for water flipback2
{triple+triple2+triple_na, PLSH9[F1]}
; or f2 channel - shaped pulse for water flipback {triple_c, PLSH16[F2]}
;sp12: f1 channel - shaped pulse for wet2 {}
; or f2 channel - shaped pulse 90 degree (higher sel., time rev.) {triple+triple2,
PLSH8[F2]}
; or f2 channel - shaped pulse 90 degree (higher sel., time rev.) {triple_na, PLSH5U[F2]}
;sp13: f1 channel - shaped pulse for wet2 {}
; or f1 channel - shaped pulse 180 degree (adiabatic) {triple_c, PLSH12[F1]}
; or f2 channel - shaped pulse 180 degree (adiabatic)
{triple+triple2+triple_na, PLSH3[F2]}
;sp14: f1 channel - shaped pulse for wet2 {}
; or f2 channel - shaped pulse 180 degree (adiabatic bilev decoupling) {default+triple+triple2,
PLSH12[F2]}
; or f3 channel - shaped pulse 180 degree (adiabatic) {triple_na, PLSH2U[F3]}
;sp15: f2 channel - shaped pulse 180 degree for decoupling (Ca or CO) {triple, PLSH10[F2]}
; or f2 channel - shaped pulse 180 degree for decoupling (Cbeta) {triple2, PLSH13[F2]}
; or f2 channel - shaped pulse 180 degree for decoupling (C') {triple_na, PLSH6U[F2]}
;sp16: f2 channel - shaped pulse 180 degree (higher sel., off res.) {triple+triple2,
PLSH9[F2]}
;sp17: f2 channel - shaped pulse 180 degree (higher sel., off res.) {triple+triple2,
PLSH9[F2]}
;sp18: f2 channel - shaped pulse 180 degree (adiabatic matched sweep) {default+triple,
PLSH15[F2]}
;sp19: f1 channel - shaped pulse for wet {default, PLSH3[F1]+0.87}
; or f2 channel - shaped pulse 90 degree (NH) {triple_c, PLSH14[F2]}
; or f3 channel - shaped pulse 90 degree (Tlrho, adiabatic ramp up) {triple2, PLSH1[F3]}
;sp20: f1 channel - shaped pulse for wet {default, PLSH3[F1]-1.04}
; or f2 channel - shaped pulse 90 degree (NH, time reversed) {triple_c, PLSH15[F2]}
; or f3 channel - shaped pulse 90 degree (Tlrho, adiabatic ramp down) {triple2, PLSH2[F3]}
;sp21: f1 channel - shaped pulse for wet {default, PLSH3[F1]+2.27}
; or f1 channel - shaped pulse 180 degree (cleanex, H2O) {triple2, PLSH11[F1]}
;sp22: f1 channel - shaped pulse for wet {default, PLSH3[F1]-5.05}
; or f1 channel - shaped pulse 90 degree (cleanex, H2O) {triple2, PLSH10[F1]}
; or f1 channel - shaped pulse 180 degree (off resonance) {triple_c, PLSH6[F1]}
;sp23: f1 channel - shaped pulse 90 degree (on resonance) {triple_c, PLSH4[F1]}
; or f1 channel - shaped pulse 180 degree (off resonance) {triple_na, PLSH1U[F1]}
;sp24: f1 channel - shaped pulse 180 degree (on resonance) {triple_c, PLSH6[F1]}
; or f1 channel - shaped pulse 180 degree (off resonance2) {triple_na, PLSH1U[F1]}
;sp25: f1 channel - shaped pulse 90 degree (on res., time reversed) {triple_c, PLSH5[F1]}
; or f2 channel - shaped pulse 180 degree (higher selectivity) {triple_na, PLSH6U[F2]}
;sp26: f1 channel - shaped pulse 180 degree (off resonance) {triple_c, PLSH6[F1]}
;sp27: f1 channel - shaped pulse 180 degree (off resonance) {triple_c, PLSH6[F1]}
;sp28: f1 channel - shaped pulse 180 degree (higher selectivity) {triple_c, PLSH14[F1]}
;sp29: f1 channel - shaped pulse 180 degree (off resonance) {triple_c, PLSH6[F1]}
; or f1 channel - shaped pulse 180 degree (adiabatic sweep: z-spoil) {default, PLSH16[F1]}

```

```

;sp30: f1 channel - shaped pulse 180 degree (sim. Ca + CO) {triple_c, PLSH15[F1]}
; or f2 channel - shaped pulse 180 degree for decoupling (sim. Ca + CO) {triple2, PLSH14[F2]}
;sp31: f2 channel - shaped pulse 180 degree (adiabatic bilev decoupling)
{default+triple+triple2+triple_na, PLSH11[F2]}

;p0 : {all, P90[F1]}
;p1 : f1 channel - 90 degree high power pulse {all, P90[F1]}
;p2 : f1 channel - 180 degree high power pulse {all, P90[F1]*2}
;p3 : f2 channel - 90 degree high power pulse {all, P90[F2]}
;p4 : f2 channel - 180 degree high power pulse {all, P90[F2]*2}
;p5 : f1 channel - 60 degree low power pulse {all, PTOC[F1]*0.66}
;p6 : f1 channel - 90 degree low power pulse {all, PTOC[F1]}
;p7 : f1 channel - 180 degree low power pulse
{default+lcnmr+triple+triple_c, PTOC[F1]*2}
; or f1 channel - 180 degree shaped pulse (cleanex sel. H2O) {triple2, PSH11[F1]}
; or f2 channel - 90 degree pulse at pl20 (TOCSY, higher sel.) {triple_na, PUSER5[F2]}
;p8 : f2 channel - 60 degree low power pulse {}
; or f1 channel - 90 degree shaped pulse (wet) {default, PSH3[F1]}
; or f1 channel - 180 degree shaped pulse (adiabatic) {triple_c, PSH12[F1]}
; or f2 channel - 180 degree shaped pulse (adiabatic) {triple+triple2+triple_na,
PSH3[F2]}
;p9 : f2 channel - 90 degree low power pulse (TOCSY) {all, PTOC[F2]}
;p10: f1 channel - 90 degree low power pulse (cleanex spinlock) {triple2, PUSER1[F1]}
; or f2 channel - 180 degree low power pulse
{default+lcnmr+triple+triple_c, PTOC[F2]*2}
; or f2 channel - 180 degree shaped pulse (higher selectivity) {triple_na, PSH6U[F2]}
;p11: f1 channel - 90 degree shaped pulse (selective excitation) {default, PSH1[F1]}
; or f1 channel - 90 degree shaped pulse (selective excitation) {triple_c, PSH4[F1]}
; or f1 channel - 90 degree shaped pulse (wet) {lcnmr, PSH3[F1]}
; or f1 channel - 90 degree shaped pulse (water flipback/watergate) {triple+triple2+triple_na,
PSH8[F1]}
;p12: f1 channel - 180 degree shaped pulse (H, selective) {default+lcnmr, PSH2[F1]}
; or f1 channel - 180 degree shaped pulse (C, adiabatic) {default+lcnmr, PSH2[F1]}
; or f1 channel - 180 degree shaped pulse (C, selective) {triple_c, PSH6[F1]}
; or f1 channel - 180 degree shaped pulse (excitation sculpting) {triple+triple2, PSH8[F1]*2}
; or f1 channel - 180 degree shaped pulse (H, selective) {triple_na, PSH1U[F1]}
;p13: f2 channel - 90 degree shaped pulse {triple+triple2, PSH4[F2]}
; or f2 channel - 90 degree shaped pulse {triple_na, PSH1U[F2]}
; or f2 channel - 90 degree shaped pulse (H, selective) {triple_c, PSH15[F2]}
;p14: f2 channel - 180 degree shaped pulse (adiabatic) {default+lcnmr, PSH3[F2]}
; or f2 channel - 180 degree shaped pulse (selective) {triple+triple2, PSH6[F2]}
; or f2 channel - 180 degree shaped pulse (selective) {triple_na, PSH3U[F2]}
;p15: f1 channel - pulse for ROESY spinlock {default+lcnmr, TROE[F1]}
; or f1 channel - 90 degree shaped pulse (cleanex sel. H2O) {triple2, PSH10[F1]}
; or f2 channel - 180 degree shaped pulse (adiabatic matched sweep) {triple, PSH15[F2]}
; or f2 channel - 90 degree shaped pulse (higher selectivity) {triple_na, PSH4U[F2]}
;p16: homospoil/gradient pulse {all, P_grad1}
;p17: f1 channel - trim pulse at pl10 or pl15 {all, P_mlev}
;p18: f1 channel - shaped pulse (off resonance presaturation)
{default+lcnmr+triple+triple2+triple_na, PSH7[F1]}
;p19: homospoil/gradient pulse 2 {all, P_grad2}
;p20: f2 channel - trim pulse {all, P_mlev}
;p21: f3 channel - 90 degree high power pulse {all, P90[F3]}
;p22: f3 channel - 180 degree high power pulse {all, P90[F3]*2}
;p23: f2 channel - 90 degree shaped pulse (higher selectivity) {triple+triple2, PSH7[F2]}
; or f2 channel - 90 degree shaped pulse (twofold modulated) {triple_na, PSH7U[F2]}
; or f4 channel - 90 degree high power pulse {default, P90[F4]}
;p24: f1 channel - 180 degree shaped pulse (adiabatic) {triple_c, PSH13[F1]}
; or f2 channel - 180 degree shaped pulse (adiabatic) {default+lcnmr, PSH2[F2]}
; or f2 channel - 180 degree shaped pulse (higher selectivity) {triple+triple2, PSH9[F2]}
; or f3 channel - 90 degree pulse at pl22 (TOCSY, higher sel.) {triple_na, PUSER4[F3]}
; or f4 channel - 180 degree high power pulse {}
;p25: f1 channel - 90 degree pulse at pl27 (pulsed ROESY) {default+lcnmr, PROE[F1]*2}
; or f1 channel - 90 degree shaped pulse (higher selectivity) {triple_c, PSH14[F1]}
; or f3 channel - pulse for t1rho experiment {pp}
; or f3 channel - pulse for TOCSY-spinlock experiment {triple}
; or f3 channel - 90 degree pulse at pl23 (TOCSY) {triple_na, PUSER3[F3]}
; or f3 channel - 180 degree low power pulse (Rexchange) {triple2, PUSER2[F3]*2}
;p26: f1 channel - 90 degree pulse at pl19 {triple*, PCPDP[F1]}
;p27: f1 channel - 90 degree pulse at pl18 (3-9-19 watergate)
{default+lcnmr+triple+triple2+triple_na, P90[F1]}
;p28: f1 channel - trim pulse at pl1 {all, P_hsqc}
;p29: f1 channel - 90 degree shaped pulse (water flipback) {default, PSH8[F1]}
; or f1 channel - 90 degree shaped pulse (water flipback2) {triple+triple_na, PSH9[F1]}

```

```

; or f2 channel - 90 degree shaped pulse (water flipback)           {triple_c, PSH16[F2]}
; or f3 channel - 90 degree shaped pulse (Tlrho adiabatic ramp)     {triple2, PSH1[F3]}
; or homospoil/gradient pulse 3                                     {pp}
;p30: f1 channel - 180 degree shaped pulse (sim. Ca + CO)          {triple_c, PSH15[F1]}
; or f2 channel - 180 degree shaped pulse (sim. Ca + CO decoupling) {triple2, PSH14[F2]}
; or f3 channel - 180 degree pulse at p123                         {triple, PTOC[F3]*2}
; or f3 channel - 180 degree shaped pulse                           {triple_na, PSH1U[F3]}
; or homospoil/gradient pulse 4                                     {pp}
; or gradient pulse for diffusion (dosy)                             {}
;p31: f2 channel - 180 degree shaped pulse (adiabatic matched sweep) {default, PSH15[F2]}
; or f2 channel - 180 degree shaped pulse (sel. Ca or CO decoupling) {triple, PSH10[F2]}
; or f2 channel - 180 degree shaped pulse (Cbeta decoupling)        {triple2, PSH13[F2]}
; or f2 channel - 180 degree shaped pulse (sel. C decoupling)       {triple_na, PSH6U[F2]}
; or f2 channel - 180 degree pulse (low power decoupling)          {1cnmr, PUSER1[F2]}
; or homospoil/gradient pulse 5                                     {pp}
;p32: f1 channel - 180 degree shaped pulse (adiabatic sweep: z-spoil) {default, PSH16[F1]}
; or f3 channel - 180 degree shaped pulse (adiabatic)              {triple_na, PSH2U[F3]}
;p33: f3 channel - trim pulse                                       {triple_na, P_mlev}
;p63: f2 channel - 180 degree shaped pulse (adiabatic bilev sweep)
{default+triple+triple2+triple_na, PSH11[F2]}

;d0 : incremented delay (2D or 3D)                                  [3 usec]
;d1 : relaxation delay; 1-5 * T1
;d2 : 1/(2J)
;d3 : 1/(3J) or 1/(6J)
;d4 : 1/(4J)
;d5 : DE/2
;d6 : delay for evolution of long range couplings
;d7 : delay for inversion recovery
;d8 : NOESY mixing time
;d9 : TOCSY mixing time                                           {all, TTOC[F1]}
;d10: incremented delay (3D)
;d11: delay for disk I/O                                           [30 msec]
;d12: delay for power switching                                     [20 usec]
;d13: short delay                                                 [4 usec]
;d14: delay for evolution after shaped pulse
;d15: TOCSY mixing time (CC)                                       {triple*, TTOC[F2]}
;d16: delay for homospoil/gradient recovery                         {all, D_grad}
;d17: delay for DANTE pulse-train
;d18: delay for evolution of long range couplings
;d19: delay for binomial water suppression
;d20: for different applications
;d21: for different applications
;d22: 1/(2J(XY))
;d23: 1/(4J(XY)) or 1/(2J(XY))
;d24: for different applications
;d25: 1/(6J(YH)) or 1/(8J(XY))
;d26: 1/(4J(YH))
;d27: for different applications
;d28: for different applications
;d29: for different applications
;d30: for different applications
;d31: for different applications

;cnst0 : for protein experiments - N chemical shift (offset, in ppm)
; or     for na experiments - calculated chemical shift (offset, in ppm)
; or     for na experiments - N(aromatic) chemical shift (offset, in ppm) [195 ppm]
;cnst1 : J (HH)
;cnst2 : J (XH)
;cnst3 : J (XX)
;cnst4 : J (YH)
;cnst5 : J (XY)
;cnst6 : J (XH)min
;cnst7 : J (XH)max
;cnst8 : bandwidth of excitation for Dante-z pulse
;cnst9 : for different applications as J
;cnst10: for different applications as J
;cnst11: for multiplicity selection
;cnst12: for multiplicity selection
;cnst13: J (XH) long range
;cnst14: J (XH) long range (min)
;cnst15: J (XH) long range (max)
;cnst16: J-scale factor

```

```

; or      for na experiments - H6/8 and/or H1' chemical shift (offset, in ppm)
;cnst17: factor to compensate for coupling evolution during a pulse
; or      for na experiments - H1' chemical shift (offset, in ppm)
;cnst18: for protein experiments - H2O chemical shift (offset, in ppm)
; or      for na experiments - H2O chemical shift (offset, in ppm)
;cnst19: for protein experiments - H(N) chemical shift (offset, in ppm)
; or      : for na experiments - H(N) chemical shift (offset, in ppm)
;cnst20: for protein experiments - Haliphatic chemical shift (offset, in ppm)
;cnst21: for na experiments - C1' chemical shift (offset, in ppm)           [90 ppm]
; or      for protein experiments - CO chemical shift (offset, in ppm)
;cnst22: for protein experiments - Calpha chemical shift (offset, in ppm)
; or      for na experiments - C6/8 chemical shift (offset, in ppm)         [137 ppm]
;cnst23: for protein experiments - Caliphatic chemical shift (offset, in ppm)
; or      for na experiments - C2' chemical shift (offset, in ppm)         [72 ppm]
;cnst24: for protein experiments - Caromatic chemical shift (offset, in ppm)
; or      for na experiments - C4 (C/U) chemical shift (offset, in ppm)     [169 ppm]
;cnst25: for protein experiments - flag for cross peak / reference experiments
; or      for na experiments - C6 (A) chemical shift (offset, in ppm)       [160 ppm]
;cnst26: for protein experiments - Call chemical shift (offset, in ppm)
; or      for na experiments - C5 (G) chemical shift (offset, in ppm)       [119 ppm]
;cnst27: for protein experiments - ( Cgamma chemical shift (offset, in ppm) )
; or      for na experiments - C2/4 chemical shift (offset, in ppm)        [152 ppm]
;cnst28: for protein experiments - Haromatic chemical shift (offset, in ppm)
; or      for na experiments - C5 (C/U) chemical shift (offset, in ppm)     [105 ppm]
;cnst29: for protein experiments - N(H) chemical shift (offset, in ppm)
; or      for na experiments - C(aro) chemical shift (offset, in ppm)       [145 ppm]
;cnst30: for protein experiments - Cbeta chemical shift (offset, in ppm)
; or      for na experiments - N(H) chemical shift (offset, in ppm)         [151 ppm]
;cnst31: scaling factor
; or      for na experiments - N(H2) chemical shift (offset, in ppm)       [81 ppm]

;vc : variable loop counter, taken from vc-list
;vd : variable delay, taken from vd-list

;l1 : loop for spinlock cycle
;l2 : loop for GARP cycle: l2 * 31.75 * 4 * p9 => Aq
;l3 : loop for phase sensitive 2D or 3D using
;      States et al. or States-TPPI method: l3 = tdl/2
;l4 : for different applications
;l5 : for different applications
;l6 : loop for shaped pulse presaturation during relaxation delay
;l7 : loop for shaped pulse presaturation during mixing time
;l8 : number of frequencies for multiple presaturation
;l11: loop for spinlock cycle 2

;$Id: $

```

```

;Relations.info
;avance-version (05/10/24)
;
;$CLASS=HighRes Info
;$COMMENT=

;The following convention is used for power levels, pulses, delays
;and loop counters in the different relation files for prosol:
;
;all = default + lcnmr + triple + triple2 + triple_c + triple_na
;triple* = triple + triple2 + triple_c + triple_na
;!__ = except
;
;prosol par.      rel. file      pulseprogram parameter
;
;D_grad          all              d16: delay for homospoil/gradient recovery
;
;P90[F1]         all              p0 :
;P90[F1]         all              p1 : f1 channel - 90 degree high power pulse
;P90[F1]         all(!triple_c)   p27: f1 channel - 90 degree pulse at p118 (3-9-19
watergate)
;P90[F1]*2      all              p2 : f1 channel - 180 degree high power pulse
;P90[F2]         all              p3 : f2 channel - 90 degree high power pulse
;P90[F2]*2      all              p4 : f2 channel - 180 degree high power pulse
;P90[F3]         all              p21: f3 channel - 90 degree high power pulse
;P90[F3]*2      all              p22: f3 channel - 180 degree high power pulse
;P90[F4]         default          p23: f4 channel - 90 degree high power pulse
;
;PCPDP[F1]      triple+triple2+triple_na p26: f1 channel - 90 degree pulse at p119
;
;PL90[F1]       all              p11 : f1 channel - power level for pulse (default)
;PL90[F1]       all(!triple_c)   p118: f1 channel - power level for 3-9-19-pulse
(watergate)
;PL90[F2]       all              p12 : f2 channel - power level for pulse (default)
;PL90[F3]       all              p13 : f3 channel - power level for pulse (default)
;PL90[F4]       all              p14 : f4 channel - power level for pulse (default)
;
;PLCPDP[F1]     all(!triple_c)   p119: f1 channel - power level for CPD/BB decoupling
;PLCPDP[F2]     all              p112: f2 channel - power level for CPD/BB decoupling
;PLCPDP[F2]     default+triple+triple2 p130: f2 channel - power level for CPD/BB decoupling
;
;PLCPDP[F2]-18 lcnmr           p126: f2 channel - power level for cw decoupling
;PLCPDP[F3]     all              p116: f3 channel - power level for CPD/BB decoupling
;PLCPDP[F4]     all              p117: f4 channel - power level for CPD/BB decoupling
;PLCPD2[F2]     default+lcnmr+triple_c p113: f2 channel - power level for second CPD/BB
decoupling
;
;PLCW[F1]       all(!triple_c)   p19 : f1 channel - power level for presaturation
;PLCW[F2]       default+lcnmr    p121: f2 channel - power level for presaturation
;PLCW[F2]       triple+triple2   p114: f2 channel - power level for cw saturation
;PLCW[F3]       lcnmr           p122: f3 channel - power level for presaturation
;
;PLHD[F2]       all              p124: f2 channel - power level for hd/hc decoupling
;
;PLNOE[F2]      default          p114: f2 channel - power level for cw saturation
;
;PLROE[F1]      all              p111: f1 channel - power level for ROESY-spinlock
;PLROE[F1]      default          p127: f1 channel - power level for pulsed ROESY-spinlock
;
;PLSH1[F1]      default          sp1 : f1 channel - shaped pulse for selective excitation
;PLSH1[F3]      triple2          sp19: f3 channel - shaped pulse 90 degree (Tlrho,
adiab. ramp up)
;PLSH2[F1]      default          sp2 : f1 channel - shaped pulse 180 degree
;PLSH2[F2]      default          sp7 : f2 channel - shaped pulse 180 degree (adiabatic)
;PLSH2[F3]      triple2          sp20: f3 channel - shaped pulse 90 degree (Tlrho,
adiab. ramp down)
;PLSH3[F1]      lcnmr           sp1 : f1 channel - shaped pulse for wet
;PLSH3[F1]      lcnmr           sp2 : f1 channel - shaped pulse for wet
;PLSH3[F1]+0.87 lcnmr           sp7 : f1 channel - shaped pulse for wet
;PLSH3[F1]+0.87 default        sp19: f1 channel - shaped pulse for wet
;PLSH3[F1]-1.04 lcnmr           sp8 : f1 channel - shaped pulse for wet
;PLSH3[F1]-1.04 default        sp20: f1 channel - shaped pulse for wet
;PLSH3[F1]+2.27 lcnmr           sp9 : f1 channel - shaped pulse for wet
;PLSH3[F1]+2.27 default        sp21: f1 channel - shaped pulse for wet
;PLSH3[F1]-5.05 lcnmr           sp10: f1 channel - shaped pulse for wet
;PLSH3[F1]-5.05 default        sp22: f1 channel - shaped pulse for wet

```



```

;PLSH3[F2]      default          sp3 : f2 channel - shaped pulse 180 degree (adiabatic)
;PLSH3[F2]      triple+triple2+triple_na sp13: f2 channel - shaped pulse 180 degree (adiabatic)
;PLSH4[F1]      triple_c          sp23: f1 channel - shaped pulse 90 degree (on
resonance)
;PLSH4[F2]      triple+triple2     sp2 : f2 channel - shaped pulse 90 degree (on
resonance)
;PLSH4[F2]      triple+triple2     sp4 : f2 channel - shaped pulse 90 degree (off
resonance)
;PLSH5[F1]      triple_c          sp25: f1 channel - shaped pulse 90 degree (on
resonance)
;PLSH5[F2]      triple+triple2     sp8 : f2 channel - shaped pulse 90 degree (on res.,
time reversed)
;PLSH6[F1]      triple_c          sp22: f1 channel - shaped pulse 180 degree (off
resonance)
;PLSH6[F1]      triple_c          sp24: f1 channel - shaped pulse 180 degree (on
resonance)
;PLSH6[F1]      triple_c          sp26: f1 channel - shaped pulse 180 degree (off
resonance)
;PLSH6[F1]      triple_c          sp27: f1 channel - shaped pulse 180 degree (off
resonance)
;PLSH6[F1]      triple_c          sp29: f1 channel - shaped pulse 180 degree (off
resonance)
;PLSH6[F2]      triple+triple2     sp3 : f2 channel - shaped pulse 180 degree (on
resonance)
;PLSH6[F2]      triple+triple2     sp5 : f2 channel - shaped pulse 180 degree (off
resonance)
;PLSH6[F2]      triple+triple2     sp7 : f2 channel - shaped pulse 180 degree (off
resonance2)
;PLSH7[F1]      all(!triple_c)    sp6 : f1 channel - shaped pulse for presaturation
;PLSH7[F2]      triple*          sp10: f2 channel - shaped pulse 90 degree (higher
selectivity)
;PLSH8[F1]      triple+triple2+triple_na sp1 : f1 channel - shaped pulse for water flipback
;PLSH8[F1]      default          sp11: f1 channel - shaped pulse for water flipback
;PLSH8[F2]      triple+triple2     sp12: f2 channel - shaped pulse 90 degree (higher
sel., time rev.)
;PLSH9[F1]      triple+triple2+triple_na sp11: f1 channel - shaped pulse for water flipback2
;PLSH9[F2]      triple+triple2     sp9 : f2 channel - shaped pulse 180 degree (higher
selectivity)
;PLSH9[F2]      triple+triple2     sp16: f2 channel - shaped pulse 180 degree (higher
selectivity)
;PLSH9[F2]      triple+triple2     sp17: f2 channel - shaped pulse 180 degree (higher
selectivity)
;PLSH10[F1]     triple2           sp22: f1 channel - shaped pulse 90 degree (H2O on
resonance)
;PLSH10[F2]     triple           sp15: f2 channel - shaped pulse 180 degree for
decoupling (Ca or CO)
;PLSH10[F2]     triple+triple2     pl28: f2 channel - power level for selective Ca or CO
decoupling
;PLSH11[F1]     triple2           sp21: f1 channel - shaped pulse 180 degree (H2O on
resonance)
;PLSH11[F2]     default+triple+triple2 sp31: f2 channel - shaped pulse 180 degree (adiabatic
decoupling)
;                +triple_na
;PLSH12[F1]     triple_c          sp13: f1 channel - shaped pulse 180 degree (adiabatic)
;PLSH12[F2]     default+triple+triple2 sp14: f2 channel - shaped pulse 180 degree (adiabatic
bilev decoupling)
;PLSH13[F1]     triple_c          sp7 : f2 channel - shaped pulse 180 degree (adiabatic)
;PLSH13[F2]     triple+triple2     pl13: f2 channel - power level for Cbeta/CO decoupling
;PLSH13[F2]     triple2           sp15: f2 channel - shaped pulse 180 degree for
decoupling (Cbeta)
;PLSH14[F1]     triple_c          sp28: f1 channel - shaped pulse 180 degree (higher
selectivity)
;PLSH14[F2]     triple2           pl29: f2 channel - power level for simultaneous Ca and
CO decoupling
;PLSH14[F2]     triple2           sp30: f2 channel - power level for simultaneous Ca and
CO decoupling
;PLSH14[F2]     triple_c          sp19: f2 channel - shaped pulse 90 degree (HN)
;PLSH15[F1]     triple_c          sp30: f1 channel - shaped pulse 180 degree (sim. Ca +
CO decoupling)
;PLSH15[F2]     default+triple     sp18: f2 channel - shaped pulse 180 degree (adiabatic
matched sweep)
;PLSH15[F2]     triple_c          sp20: f2 channel - shaped pulse 90 degree (HN tr)
;PLSH16[F1]     default          sp29: f1 channel - shaped pulse 180 degree (adiabatic:
z-spoil)
;PLSH16[F2]     triple_c          sp11: f2 channel - shaped pulse 90 degree (water
flipback)
;

```

```

;PLSH1U[F1]      triple_na      sp23: f1 channel - shaped pulse 180 degree (_NA: H)
;PLSH1U[F1]      triple_na      sp24: f1 channel - shaped pulse 180 degree (_NA: H)
;PLSH1U[F2]      triple_na      sp2 : f2 channel - shaped pulse 90 degree (_NA: C)
;PLSH1U[F3]      triple_na      sp9 : f3 channel - shaped pulse 180 degree (_NA: N)
;PLSH2U[F2]      triple_na      sp8 : f2 channel - shaped pulse 90 degree (_NA: C, tr)
;PLSH2U[F3]      triple_na      sp14: f3 channel - shaped pulse 180 degree (_NA: N,
adiabatic)
;PLSH3U[F2]      triple_na      sp3 : f2 channel - shaped pulse 180 degree (_NA: C)
;PLSH3U[F2]      triple_na      sp5 : f2 channel - shaped pulse 180 degree (_NA: C)
;PLSH3U[F2]      triple_na      sp7 : f2 channel - shaped pulse 180 degree (_NA: C)
;PLSH4U[F2]      triple_na      sp10: f2 channel - shaped pulse 90 degree (_NA: C,
higher sel.)
;PLSH5U[F2]      triple_na      sp12: f2 channel - shaped pulse 90 degree (_NA: C,
higher sel., tr)
;PLSH6U[F2]      triple_na      sp15: f2 channel - shaped pulse 180 degree (_NA: C,
decoupling)
;PLSH6U[F2]      triple_na      sp25: f2 channel - shaped pulse 180 degree (_NA: C,
higher sel.)
;PLSH6U[F2]      triple_na      pl28: f2 channel - shaped pulse 180 degree (_NA: C,
decoupling)
;PLSH7U[F2]      triple_na      sp0 : f2 channel - shaped pulse 180 degree (_NA: C,
twofold mod)
;
;PLTOC[F1]       all             pl10: f1 channel - power level for TOCSY-spinlock
;PLTOC[F2]       all             pl15: f2 channel - power level for TOCSY-spinlock
;PLTOC[F3]       all(!triple2+triple_na) pl23: f3 channel - power level for TOCSY-spinlock
;
;PLUSER1[F1]     triple2         pl27: f1 channel - power level for CLEANEX spinlock
;PLUSER1[F2]     lcnmr          pl14: f2 channel - power level for low power decoupling
;PLUSER1[F3]     triple*        pl25: f3 channel - power level for TIRHO spinlock
;PLUSER2[F2]     default+triple+triple2 pl31: f2 channel - power level for bilev dec. (cw part)
;                +triple_na
;PLUSER2[F3]     triple2         pl23: f3 channel - power level for Rexchange
;PLUSER3[F1]     triple_na      pl25: f1 channel - power level for hetero TOCSY
;PLUSER3[F2]     triple_na      pl26: f2 channel - power level for hetero TOCSY
;PLUSER3[F3]     triple_na      pl23: f3 channel - power level for hetero TOCSY
;PLUSER4[F2]     triple_na      pl27: f2 channel - power level for hetero TOCSY higher
sel.
;PLUSER4[F3]     triple_na      pl22: f3 channel - power level for hetero TOCSY higher
sel.
;PLUSER5[F2]     triple_na      pl20: f2 channel - power level for TOCSY higher sel.
;
;PROE[F1]*2      default+lcnmr   p25: f1 channel - 90 degree pulse at pl27 (pulsed
ROESY)
;
;PSH1[F1]        default        p11: f1 channel - 90 degree shaped pulse (selective
excitation)
;PSH1[F3]        triple2         p29: f3 channel - shaped pulse for adiabatic ramping
;PSH2[F1]        default+lcnmr   p12: f1 channel - 180 degree shaped pulse (C, adiabatic)
;PSH2[F1]        default+lcnmr   p12: f1 channel - 180 degree shaped pulse (H, selective)
;PSH2[F2]        default+lcnmr   p24: f2 channel - 180 degree shaped pulse (adiabatic)
;PSH3[F1]        lcnmr          p11: f1 channel - 90 degree shaped pulse (wet)
;PSH3[F1]        default        p8 : f1 channel - 90 degree shaped pulse (wet)
;PSH3[F2]        default+lcnmr   p14: f2 channel - 180 degree shaped pulse (adiabatic)
;PSH3[F2]        triple+triple2+triple_na p8 : f2 channel - 180 degree shaped pulse (adiabatic)
;PSH4[F1]        triple_c        p11: f1 channel - 90 degree shaped pulse
;PSH4[F2]        triple+triple2   p13: f2 channel - 90 degree shaped pulse
;PSH6[F1]        triple_c        p12: f1 channel - 180 degree shaped pulse (selective)
;PSH6[F2]        triple+triple2   p14: f2 channel - 180 degree shaped pulse (selective)
;PSH7[F1]        all(!triple_c)  p18: f1 channel - shaped pulse (off resonance
presaturation)
;PSH7[F2]        triple+triple2   p23: f2 channel - 90 degree shaped pulse (higher
selectivity)
;PSH8[F1]        triple+triple2+triple_na p11: f1 channel - 90 degree shaped pulse (water
flipback/watergate)
;PSH8[F1]*2      triple+triple2   p12: f1 channel - 180 degree shaped pulse (excitation
sculpting)
;PSH8[F1]        default        p29: f1 channel - 90 degree shaped pulse (water
flipback)
;PSH9[F1]        triple+triple_na p29: f1 channel - 90 degree shaped pulse (water
flipback2)
;PSH9[F2]        triple+triple2   p24: f2 channel - 180 degree shaped pulse (higher
selectivity)
;PSH10[F1]       triple2         p15: f1 channel - 90 degree shaped pulse (H2O on
resonance)
;PSH10[F2]       triple          p31: f2 channel - 180 degree shaped pulse (sel. Ca or CO
decoupling)

```

```

;PSH11[F1]      triple2          p7 : f1 channel - 180 degree shaped pulse (H2O on
resonance)
;PSH11[F2]      default+triple+triple2  p63 : f2 channel - 180 degree shaped pulse (adiabatic
decoupling)
;
+triple_na
;PSH12[F1]      triple_c          p8 : f1 channel - 180 degree shaped pulse (adiabatic)
;PSH13[F1]      triple_c          p24: f1 channel - 180 degree shaped pulse (adiabatic)
;PSH13[F2]      triple*           pcpd8: f2 channel - 180 degree shaped pulse (Cbeta
decoupling)
;PSH13[F2]      triple2          p31: f2 channel - 180 degree shaped pulse (Cbeta
decoupling)
;PSH14[F1]      triple_c          p25: f1 channel - 180 degree shaped pulse (higher
selectivity)
;PSH14[F2]      triple2          p30: f2 channel - 180 degree shaped pulse (sim. Ca + CO
decoupling)
;PSH15[F1]      default          p31: f1 channel - 180 degree shaped pulse for inversion
(adiabatic matched sweep)
;PSH15[F1]      triple_c          p30: f1 channel - 180 degree shaped pulse (sim. Ca + CO
decoupling)
;PSH15[F2]      triple           p15: f2 channel - 180 degree shaped pulse for inversion
(adiabatic matched sweep)
;PSH15[F2]      triple_c          p13: f2 channel - 90 degree shaped pulse (H, selective)
;PSH16[F1]      default          p32: f1 channel - 180 degree shaped pulse for inversion
(adiabatic: z-spoil)
;PSH16[F2]      triple_c          p29: f2 channel - 90 degree shaped pulse for inversion
(water flipback)
;
;PSH1U[F1]      triple_na         p12: f1 channel - 180 degree shaped pulse (_NA: H)
;PSH1U[F2]      triple_na         p13: f2 channel - 90 degree shaped pulse (_NA: C)
;PSH1U[F3]      triple_na         p30: f3 channel - 180 degree shaped pulse (_NA: N)
;PSH2U[F3]      triple_na         p32: f3 channel - 180 degree shaped pulse (_NA: N,
adiabatic)
;PSH3U[F2]      triple_na         p14: f2 channel - 180 degree shaped pulse (_NA: C)
;PSH4U[F2]      triple_na         p15: f2 channel - 90 degree shaped pulse (_NA: C,
higher sel.)
;PSH6U[F2]      triple_na         p10: f2 channel - 180 degree shaped pulse (_NA: C,
higher sel.)
;PSH6U[F2]      triple_na         p31: f2 channel - 180 degree shaped pulse (_NA: C,
decoupling)
;PSH7U[F2]      triple_na         p23: f2 channel - 180 degree shaped pulse (_NA: C,
twofold mod)
;
;PTOC[F1]       all              p6 : f1 channel - 90 degree low power pulse
;PTOC[F1]*0.66  all(!triple_na)   p5 : f1 channel - 60 degree low power pulse
;PTOC[F1]*2     all(!triple2+triple_na) p7 : f1 channel - 180 degree low power pulse
;PTOC[F2]       all              p9 : f2 channel - 90 degree low power pulse
;PTOC[F2]*2     all(!triple2+triple_na) p10: f2 channel - 180 degree low power pulse
;PTOC[F3]       triple           p25: f3 channel - 90 degree pulse at p123
;PTOC[F3]*2     triple           p30: f3 channel - 180 degree pulse at p123
;
;PUSER1[F1]     triple2          p10: f1 channel - 180 degree low power pulse (CLEANEX
spinlock)
;PUSER1[F2]     lcnmr           p31: f2 channel - 90 degree low power pulse
(decoupling)
;PUSER2[F3]*2   triple2          p25: f3 channel - 180 degree low power pulse (Rexchange)
;PUSER3[F3]     triple_na        p25: f3 channel - 90 degree low power pulse (hetero
TOCSY)
;PUSER4[F3]     triple_na        p24: f3 channel - 90 degree low power pulse (hetero
TOCSY higher sel.)
;PUSER5[F2]     triple_na        p7 : f2 channel - 90 degree low power pulse (TOCSY
higher sel.)
;
;P_grad1        all              p16: homospoil/gradient pulse
;P_grad2        all              p19: homospoil/gradient pulse 2
;P_hsqc         all              p28: f1 channel - trim pulse at p11
;P_mlev         all              p17: f1 channel - trim pulse at p110
;P_mlev         all(!lcnmr)     p20: f2 channel - trim pulse at p115
;P_mlev         triple_na       p33: f3 channel - trim pulse at p123
;
;TROE[F1]       default+lcnmr    p15: f1 channel - pulse for ROESY spinlock
;
;TTOC[F1]       all              d9 : TOCSY mixing time
;TTOC[F2]       triple*          d15: TOCSY mixing time (CC)

;$Id: $

```